

HUGO GERNSBACK, Editor

RADIO CRAFT

In this issue—

Switching and triggering

Multi-station intercoms

Experiments on 420 mc

LIGHTWEIGHT RADAR
FOR SAFE FLYING

SEE PAGE 22



MAR

1947

25¢

GENSBA 30c

RADIO-ELECTRONICS IN ALL ITS PHASES

hallicrafters PRESENTS THE

SX-42

Another first!
Greatest continuous frequency coverage of any communications receiver — from 540 kc to 110 Mc

This is the long-awaited Hallicrafters SX-42, a truly great communications receiver. The tremendous frequency range of the SX-42, *greater than ever before available in a receiver of this type*, is made possible by the development of a new "split-stator" tuning system and the use of dual intermediate frequency transformers. Packed with advance features that every ham and every other radio enthusiast desires, the SX-42 clearly lives up to the Hallicrafters' ideal of "the radio man's radio."

From now on watch Hallicrafters — the name that's remembered by the veteran, preferred by the radio amateur. See your distributor for demonstration of the SX-42 and for colorful literature describing this great set in complete technical detail.



Because of the precise and thorough engineering that must be done on the SX-42 and because the parts supply has not been continuous, top production peaks have not yet been reached. In the immediate future deliveries will necessarily run behind the demand, but the SX-42 is definitely worth waiting for.



hallicrafters RADIO

THE HALLICTRAFTERS CO., MANUFACTURERS OF RADIO AND ELECTRONIC EQUIPMENT, CHICAGO 16, U. S. A.

Sole Hallicrafters Representatives in Canada:
Rogers Majestic Limited, Toronto-Montreal

BUILDERS OF *Skyfone* AVIATION RADIOTELEPHONE



I Will Show You How to Learn RADIO by Practicing in Spare Time

I Send You Big Kits of Radio Parts



KIT 1
I send you Soldering Equipment and Radio parts; show you how to do Radio soldering; how to mount and connect Radio parts; give you practical experience.



KIT 2
Early in my course I show you how to build this N.R.I. Tester with parts I send. It soon helps you fix neighborhood Radios and earn EXTRA money in spare time.

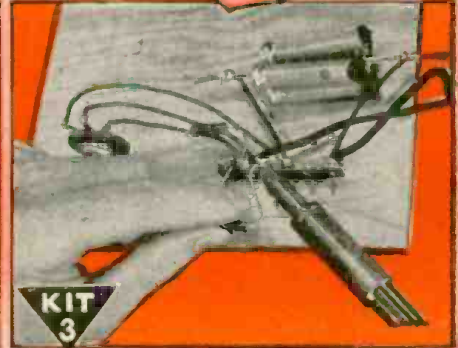

KIT 3
You get parts to build Radio Circuits; then test them; see how they work, learn how to design special circuits; how to locate and repair circuit defects.

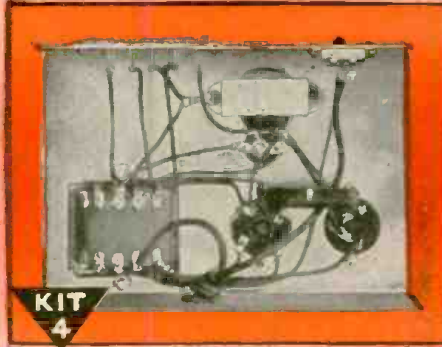

KIT 4
You get parts to build this Vacuum Tube Power Pack; make changes which give you experience with packs of many kinds; learn to correct power pack troubles.

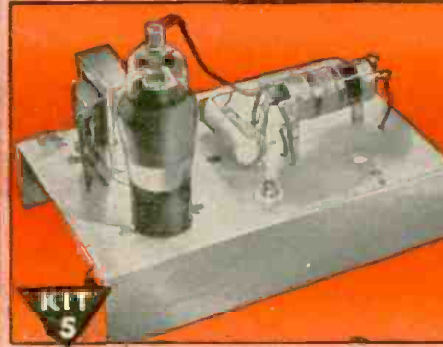

KIT 5
Building this A. M. Signal Generator gives you more valuable experience. It provides amplitude-modulated signals for many tests and experiments.



KIT 6
You build this Superheterodyne Receiver which brings in local and distant stations—and gives you more experience to help you win success in Radio.

I Will Train You at Home - SAMPLE LESSON FREE

Do you want a good-pay job in Radio—or your own money-making Radio Shop? Mail Coupon for a FREE Sample Lesson and my FREE 64-page book, "How to Be a Success in RADIO—Television, Electronics." See how N.R.I. gives you practical Radio experience at home—building, testing, repairing Radios with BIG KITS OF PARTS I send!

Many Beginners Soon Make Good Extra Money in Spare Time While Learning

The day you enroll I start sending EXTRA MONEY JOB SHEETS. You LEARN Radio principles from my easy-to-grasp, illustrated lessons—PRACTICE what you learn with parts I send—USE your knowledge to make EXTRA money fixing neighbors' Radios in spare time while still learning! From here it's a short step to your own full-time Radio Shop or a good Radio job!

VETERANS
You can get this training right in your own home under G. I. Bill.
Mail coupon for full details.

Future for Trained Men Is Bright in Radio, Television, Electronics

It's probably easier to get started in Radio now than ever before because the Radio Repair business is booming. Trained Radio Technicians also find profitable opportunities in Police, Aviation, Marine Radio, Broadcasting, Radio Manufacturing, Public Address work. Think of even greater opportunities as Television and Electronics become available to the public! Send for free books now!

Find Out What N.R.I. Can Do for You

Mail Coupon for Sample Lesson and my 64-page book. Read the details about my Course. Read letters from men I trained, telling what they are doing, earning. See how quickly, easily you can get started. No obligation! Just MAIL COUPON NOW in an envelope or paste it on a penny postal. J. E. SMITH, President, Dept. 7CX, National Radio Institute, Pioneer Home Study Radio School, Washington 9, D. C.

Our 33rd Year of Training Men for Success in Radio
My training includes TELEVISION • ELECTRONICS • FM

Good for Both - FREE

Mr. J. E. SMITH, President, Dept. 7CX
National Radio Institute, Washington 9, D. C.
Mail me FREE, without obligation, Sample Lesson and 64-page book about how to win success in Radio and Television—Electronics. (No salesman will call. Please write plainly.)

Age

Name

Address

City State
(Please include Post Office zone number)



APPROVED FOR TRAINING UNDER GI BILL

SYLVANIA NEWS

RADIO SERVICE EDITION

MARCH Prepared by SYLVANIA ELECTRIC PRODUCTS INC., Emporium, Pa. 1947

RADIO SERVICEMEN! YOU NEED THIS NEW OSCILLOSCOPE FOR RAPID ALIGNMENT AND TROUBLE-SHOOTING

To make your servicing job easier and faster, Sylvania developed the 3-Inch Cathode Ray Oscilloscope, Type 131.

This accurate measuring device is especially useful in rapid receiver alignment, distortion locating, general trouble-shooting.

Now you can quickly and easily solve problems met in radios and electronic equipment.

Note characteristics and special features below.



CHARACTERISTICS and SPECIAL FEATURES

- | | | |
|---|---|---|
| <p>1. Sylvania 3API Cathode Ray Tube — Accelerating potential, 650 volts. Electrostatic deflection and focus. Tube is shock-mounted and well protected from stray magnetic and electrostatic fields by efficient shielding. Panel visor shades face of tube permitting oscilloscope use in well-lighted rooms. Removable calibrating screen also included.</p> <p>2. INPUT IMPEDANCES —
Vertical amplifier — approximately 1 meg., 30 mmf. at full gain.
Horizontal amplifier — approximately 1 meg., 50 mmf. at full gain.</p> | <p>Vertical direct — approximately 0.68 meg., 45 mmf.
Horizontal direct — approximately 0.68 meg., 60 mmf.</p> <p>3. AMPLIFIER FREQUENCY RESPONSE —
Sine wave uniform within 3 db. from 10 cycles to 100 kilocycles.</p> <p>4. DEFLECTION FACTOR —
Through amplifiers — 0.5 volts per inch.
Direct — approximately 17 volts per inch.</p> | <p>5. HORIZONTAL SWEEP —
Direction — left to right.
Frequency range — 15 to 40,000 cycles.
Synchronizing signal sources — Internal (vertical signal) External; 60 cycles.</p> <p>6. POWER SUPPLY —
105-125 volts, 50-60 cycles.
40 watts power consumption.
1 amp. line fuse provided.</p> <p>7. CABINET DIMENSIONS —
10$\frac{1}{8}$" high, 7$\frac{3}{4}$" wide, 13$\frac{3}{8}$" deep.
<i>See your Sylvania Distributor.</i></p> |
|---|---|---|

SYLVANIA ELECTRIC

Emporium, Pa.

MAKERS OF RADIO TUBES; CATHODE RAY TUBES; ELECTRONIC DEVICES; FLUORESCENT LAMPS, FIXTURES, WIRING DEVICES; ELECTRIC LIGHT BULBS

Don't Waste Time Figuring How to Take It Apart

PHOTOFACT*

FOLDERS

give you complete
disassembly
instructions



Do you lose valuable time discovering how to take out chassis, speakers and record changers from some of the new combinations? Are you familiar in all cases with *the proper sequence of removal*? Whenever the procedure is complicated, PHOTOFACT FOLDERS give you complete disassembly instructions—enable you to do an efficient job without damaging panels, dials, grilles or any other parts of the set. Better still, you're sure of getting them back together again in the quickest possible time.

That's not all PHOTOFACT FOLDERS do. They make it easy to diagnose trouble, locate defective parts, decide on adequate replacements and *get them in a hurry*. They do this by means of exclusive numbered photographs, full-page easy-to-read schematics, complete parts listings, record changer anal-

yses and many other helps that assist you in making *up to twice as many repairs a day*.

PHOTOFACT FOLDERS are the result of actually examining and testing the instruments covered. They are based on *original research*—not on "canned" or copied information. They cover *all* the latest radios, phonographs, record changers, recorders, communications systems and power amplifiers. Sent to you in sets of 30 to 50 folders, they cost only \$1.50 a set. This includes membership in the Howard W. Sams Institute. Actually they cost you nothing for they pay for themselves over and over again in time saved.

Over 25,000 radio service engineers use and depend on them! Give servicing worries the go-by! Spend less time, do better work—and more of it—by seeing your distributor or by using the convenient coupon.

PUBLICATION DATES

Set No. 13 . . . February 10

Set No. 14 . . . February 25

Cut this out and MAIL OR TAKE IT TO YOUR DISTRIBUTOR. If you do not know his name and address, send it directly to Howard W. Sams & Co., Inc., 2924 East Washington Street, Indianapolis 6, Indiana, and we will see that your nearest distributor gets it. In Canada, write to A. C. SIMMONDS & SONS, 301 King Street East, Toronto, Ontario. Canadian Price, \$1.75.

Send Set No. 14 (Feb. 25)

Send Set No. 13 (Feb. 10)

Send Set No. 12 (Jan. 25)

Send Set No. 11 (Jan. 10)

Send me Volume 1 (including Sets Nos. 1 to 10) with De Luxe Binder, \$18.39. Individual Sets Nos. 1 to 10, \$1.50 each.

Send me a De Luxe Binder (at \$3.39)

My (check) (money order) (cash) for is enclosed. (If you send cash, be sure to use registered mail.)

PLEASE PRINT

Name _____

Address _____

City _____ Zone _____ State _____

Company Name _____

My Distributor's Name _____

City _____

*Trade Mark Reg.

HOWARD W. **SAMS** & CO., INC. **RADIO PHOTOFACT SERVICE**

In Canada—write to A. C. SIMMONDS & SONS, 301 King Street East, Toronto, Ontario

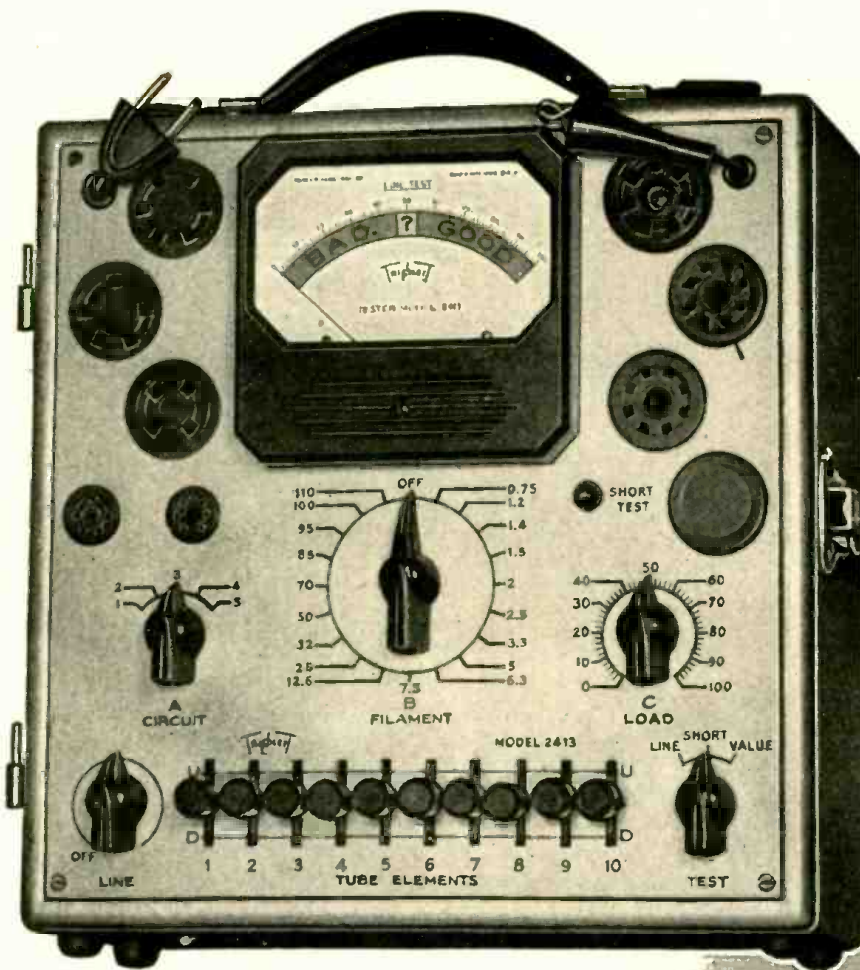

**MODEL
2413**

T
is another
member of the
NEW TRIPPLETT
Square Line

The New Speed-Chek Tube Tester

MORE FLEXIBLE • FAR FASTER • MORE ACCURATE

Three-position lever switching makes this sensational new model one of the most flexible and speediest of all tube testers. Its multi-purpose test circuit provides for standardized VALUE test; SHORT AND OPEN element test and TRANSCONDUCTANCE comparison test. Large 4" square RED • DOT life-time guaranteed meter.

Simplicity of operation provides for the fastest settings ever developed for practical tube testing. Gives individual control of each tube element.

New SQUARE LINE series metal case 10" x 10" x 5½", striking two-tone hammered baked-on enamel finish. Detachable cover. Tube chart 8" x 9" with the simple settings marked in large easy to read type. Attractively priced. Write for details.

Additional Features

- Authoritative tests for tube value; shorts, open elements, and transconductance (mutual conductance) comparison for matching tubes.
- Flexible lever-switching gives individual control for each tube element; provides for roaming elements, dual cathode structures, multi-purpose tubes, etc.
- Line voltage adjustment control.
- Filament Voltages, 0.75 to 110 volts, through 19 steps.
- Sockets: One only each kind required socket plus one spare.
- Distinctive appearance with 4" meter makes impressive counter tester—also suitable for portable use.

*Precision first
...to last*



Triplett

ELECTRICAL INSTRUMENT CO. BLUFFTON, OHIO

RADIO-CRAFT for MARCH, 1947



Save SPACE, TIME and MONEY!

with the **PYRAMID "TYNEE-DRY"**

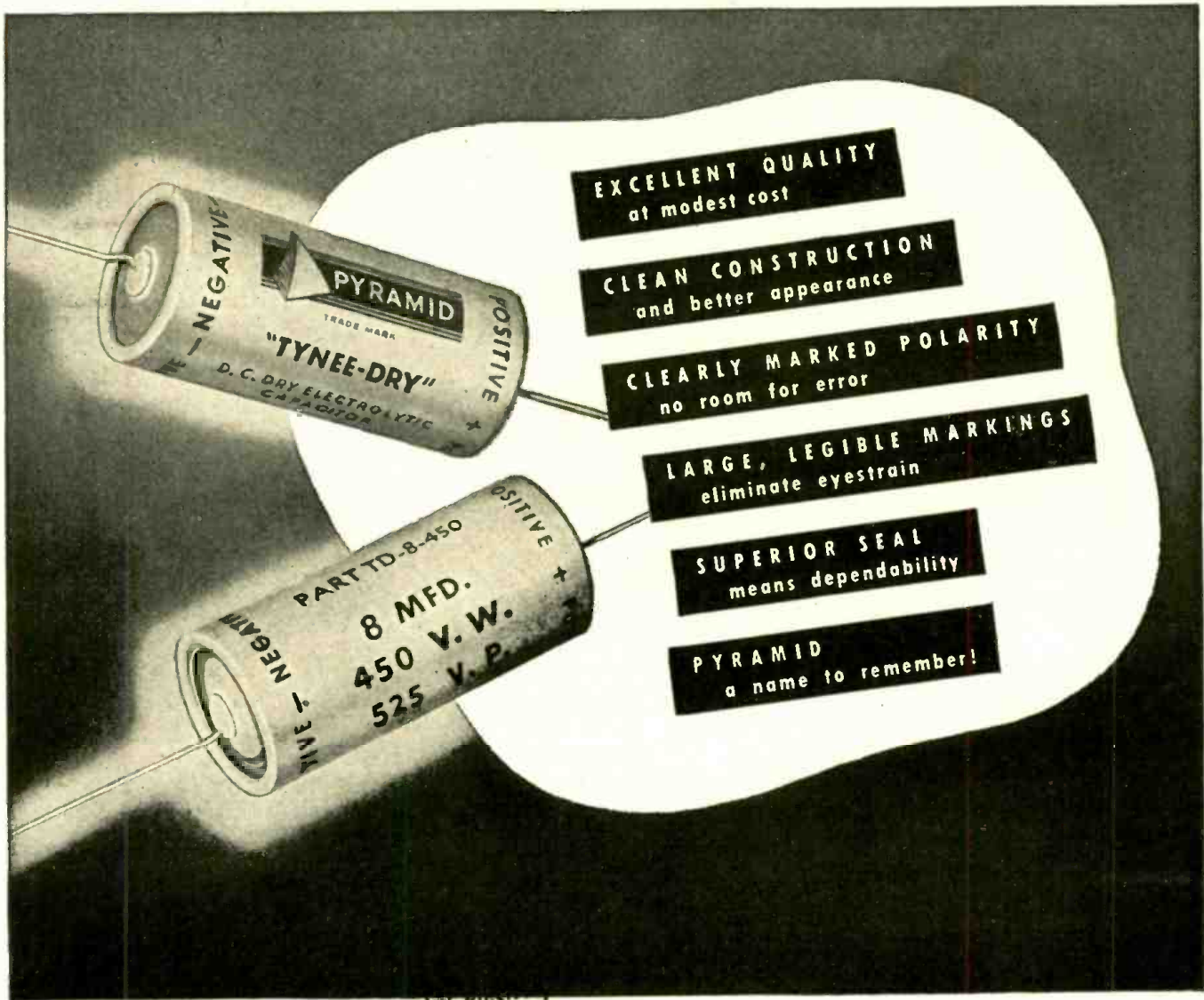

tiny dry electrolytic

engineering and production controls provide maximum
quality within minimum space—and at
modest cost! Write for literature.

PYRAMID ELECTRIC COMPANY
JERSEY CITY 6, N. J.

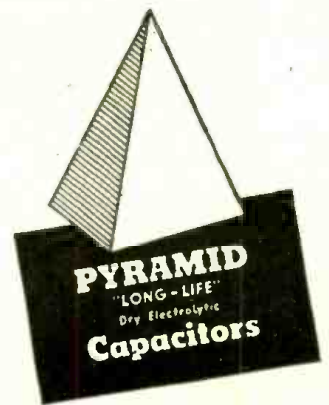

BUY at NEWARK FOR REAL ECONOMY AND TOP QUALITY

Fresh Stock! NEWARK CRYSTALS

6-11-20-40-80 METERS
Here's more of these precision cut, low drift crystals! Accurately calibrated, fully guaranteed.

80 Meter Type X1—3500-4000
40 " " X2—7000-7300
11 " " X3—6250-6750
6 " " X4—6797-6866
20 " " X5—8335-9000 KC
" " X6—14100-14300

Send your order now. We will fill from stock to nearest specified frequency.
Sensational value at... **88¢**

3 Asst. for only \$2.40

in Stock! GON-SET CONVERTERS

FOR 20, 10-11,
OR 6 METERS

A necessary and reliable adjunct to your present receivers. For fixed and mobile use. Built-in pre-selection. Well-constructed, complete with connecting cables. Your cost—each, any type... **\$39⁹⁵**
Special Noise Silencer..... 8.25



DETROLA RECORD CHANGER

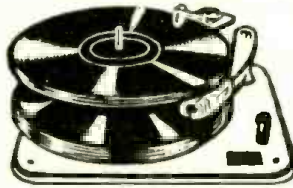

10" or 12" records. Free floating tone arm has high fidelity crystal pickup. Gearless, foolproof mechanism. Sensationally low price... **\$14⁹⁵**

Sturdy base, walnut finish, mounting holes and cutout provided. Your cost **\$2.49**

Build Your Own Record Player

A sturdy rim drive phonomotor — 78 r.p.m. Lightweight, high fidelity crystal pickup. Combination motor and turntable and pickup sell regularly for \$15. Now you can own both, less cabinet, for only



\$5.95

TWO-CHANNEL CONTROL BOX

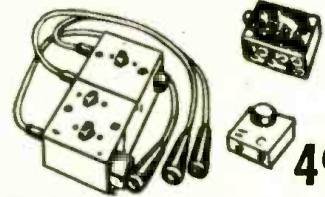

49¢

This 2 channel control box has wide and varied application in Ham shacks, P.A. and intercom work. Incorporates 4P. DT gang switches, 3 terminal plugs, several 1/4-watt resistors and illuminated dial light including bulb, three 5 ft. cables and plugs. Brand new — a terrific buy!

NEW DYNAMOTOR

POWER SUPPLY



A fortunate buy enables us to offer a sensational new low price. All brand new. Operates from 6-12 Volt battery. Delivers 500 V DC at 160 ma. Special, your cost **\$9⁹⁵**

Best Buy of the Year!

1 MIL METER

3 1/2 in. R. D. CASE

A sensational value, this meter has higher sensitivity than a comparable movement selling for many times this price.

Basic movement is 0-1 mil and has a resistance of only 75 Ohms, with special construction to provide excellent damping. Scale reads 0-2 MA, 0-40 MA—has internal multiplier of 100r.

Only 600 available at this extremely low price—Order now. **\$3⁹⁵**



WESTINGHOUSE 3 1/2 AC VOLTMETER

RECTIFIER TYPE

A rectifier type AC Voltmeter having sensitivity of 2,000 ohms per Volt. Basic movement 0-500 Micro Amps with enclosed rectifier. Scale reading 0-2 Volt.

Round 3 1/2" Bakelite Case. Meter made to sell for \$17.00. Now at Newark for only **\$3⁹⁵**



0-500 MICROAMMETER

Just received an additional shipment of these outstanding 2 1/2" meters having a 0-500 MA movement, well damped, and with a 0-600 V. D.C. scale.

A swell meter for your rig or to have around the bench as a spare. Don't fail to get yours at this especially low price **\$2⁹⁵**



Standard Receivers Now Available!

HALLICRAFTERS

S-38 complete \$47.50
S-40A complete \$89.50
SX-42 \$275.00

NATIONAL

HRO-5Tal complete... 306.71
NC-240D with speaker 241.44
NC-46 with speaker... 107.40
1-10A with tubes, less speaker and power supply 67.50

HAMMARLUND

HQ-129X complete .. 173.25
SP-400X complete ... 342.00
RME-45 complete 198.70
RME-84 complete 98.70
Panadaptor 99.75
Temco 75 GA XMTR.. 495.00
Meck Transmitters... 150.00

Mail orders filled promptly FOB New York or Chicago. Send 20% deposit with order. Prices subject to change.



T-17B MICROPHONE

Sturdy, high quality, lightweight 200 ohm single button carbon mike with press to talk button for transmitters, P.A., etc. Built in filter. **\$1.49**

DON'T MISS THIS!

Dynamic type earphone and microphone assembly that's a wonder of convenience, efficiency and compactness. 50 ohm impedance. 37" cord and plug. A TOP SPECIAL **\$2⁹⁵**

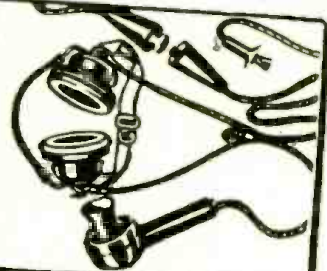

NEWARK'S SPECIAL FILTER CONDENSERS

Oil Filled—Oil Impregnated—Fully Guaranteed At Rated Voltages
Acclaimed by hams everywhere, these Newark condensers have been preferred favorites with amateurs for over ten years. Top quality at ridiculously low cost. Newark value at its best.

Mfd.	Working Voltage	Height	Width	Depth	Weight	Price
1	4000 D.C.	2 1/2"	1 1/2"	1"	8 oz.	\$.89
1	1000 D.C.	2 1/2"	1 1/2"	1"	8 oz.	.49
2	1000 D.C.	3 1/2"	1 1/2"	1"	12 oz.	.49
2.5	1500 D.C.	4 1/2"	1 1/2"	1"	12 oz.	.89
4	1500 D.C.	4 1/2"	1 1/2"	Rd. Can	8 oz.	1.99
4	3000 D.C.	3 1/2"	1 1/2"	1"	1 1/2 lbs.	3.95
6	3000 D.C.	4"	3 1/2"	3 5/16"	2 1/2 lbs.	3.75
8	3000 D.C.	6"	5"	2 1/2"	2 1/2 lbs.	3.95
8	3000 D.C.	4 1/2"	3 1/2"	2 1/2"	6 lbs.	3.25
10	3000 D.C.	7 1/2"	6 1/2"	3 1/2"	2 1/2 lbs.	2.75
13	1000 D.C.	4 1/2"	3 1/2"	3 1/2"	7 1/2 lbs.	3.95
15	3000 D.C.	3 1/2"	3 1/2"	1 1/2"	3 1/2 lbs.	4.75
15	3000 D.C.	4 1/2"	4 1/2"	3 1/2"	1 1/2 lbs.	2.25
2	600 D.C.	4 1/2"	2 1/2"	1 1/2"	5 lbs.	5.25
2	800 D.C.	4 1/2"	2 1/2"	1 1/2"	14 oz.	.80
5	1000 D.C.	4 1/2"	2 1/2"	2 1/2"	2 lbs.	1.25
5	1000 D.C.	3 1/2"	4 1/2"	3 1/2"	4 1/2 lbs.	1.75

*IN ONE CAN.

• MAIL ORDERS FILLED FROM EITHER NEW YORK OR CHICAGO
• Write: 242-F W. 55th St., N. Y. C. or 323-F W. Madison St., Chicago

NEW YORK
Offices & Warehouse
242 W. 55th St., N.Y. 19

NEWARK

ELECTRIC COMPANY, INC.

CHICAGO
323 W. Madison St.
Chicago 6, Ill.

New York City Stores: 115-17 W. 45th St. & 212 Fulton St.

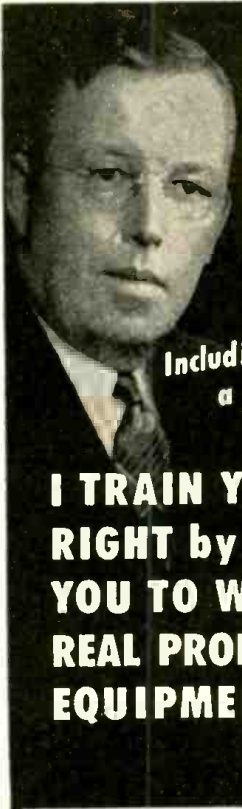

NOW! An Amazing Opportunity to LEARN RADIO AT HOME

I SEND YOU 8 BIG KITS OF RADIO PARTS

Including a COMPLETE 6 TUBE SUPER-HETERODYNE RECEIVER

I TRAIN YOU RIGHT by PUTTING YOU TO WORK with REAL PROFESSIONAL EQUIPMENT!

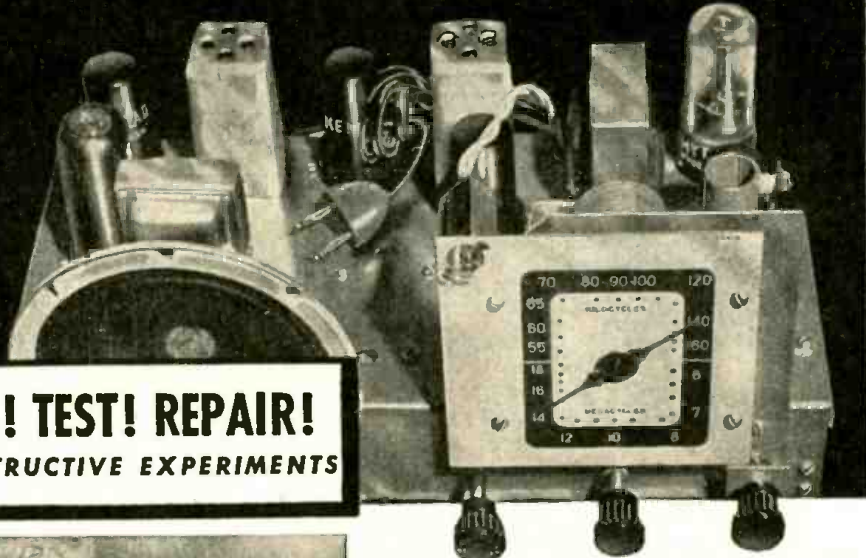

LEARN HOW TO BUILD CIRCUITS! TEST! REPAIR!
YOU DO OVER 175 INSTRUCTIVE EXPERIMENTS



YOU BUILD THIS USEFUL TEST EQUIPMENT!

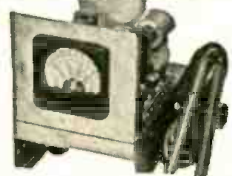

I give you a fine, moving-coil type Meter Instrument on Jewel Bearings — with parts for a complete Analyzer Circuit Continuity Tester. You learn how to check and correct Receiver defects with professional accuracy and speed.

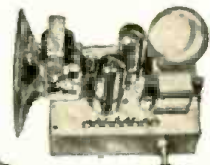

You'll get valuable experience and practice building this Signal Generator and Multi-purpose Tester. Makes a breeze out of fixing Radios and you don't have to spend money on outside, ready-made equipment.

HERE'S THE EASIEST, MOST PRACTICAL WAY OF ALL TO PREPARE FOR GOOD PAY in RADIO ELECTRONICS and TELEVISION!

I train your mind by putting you to work with your hands on a big 6-Tube Superheterodyne Receiver. And, believe me, when you get busy with real Radio Parts — 8 big Kits of them — you really LEARN Radio and learn it RIGHT! You get the practical stuff you need to be useful in Radio, and that's what it takes to make money. You don't have to worry about what to do with these 8 Kits of Parts. Step by step, I show you how to build circuits, test, experiment, trouble-shoot. And you don't need any previous experience. The Sprayberry Course starts right at the beginning of Radio! You can't get lost! Simplified lessons, coupled with real "Shop" practice, makes every subject plain and easy to understand and remember. Soon after you begin Sprayberry Training, I'll send you my sensational BUSINESS BUILDERS.

A BUSINESS OF YOUR OWN . . . OR A GOOD RADIO JOB
You'll find out how to get and do neighborhood Radio repair jobs for nice profits and rich experience while learning. This sort of work can easily pave the way for a Radio Service business of your own. But with Sprayberry Training, you're not limited. You can swing into any one of the swiftly expanding branches of Radio-Electronics INCLUDING Radio, Television, FM, Radar, Industrial Electronics. Be wise! Decide now to become a fully qualified RADIO - ELECTRONICIAN. Get full details about my Training at once! Mail coupon below for my 2 big FREE Books.

Soldering, wiring, connecting Radio parts . . . building circuits — you can't beat this method of learning. When you construct this Rectifier and Filter, Resistor and Condenser Tester, etc., you get a really practical slant on Radio.



GET THESE VALUABLE FREE BOOKS

"How to Read Radio Diagrams and Symbols"

Here's a valuable and wonderfully complete new book which explains in simple English how to read and understand any Radio Set Diagram. Includes translation of all Radio symbols. Send for this volume at once. It's free! Along with it, I will send you another Big Free book describing in detail my Radio-Electronic Training.

RUSH COUPON!

SPRAYBERRY ACADEMY OF RADIO
F. L. Sprayberry, President, Room 2037, Pueblo, Colorado

Please rush my FREE copies of "How to MAKE MONEY in RADIO, ELECTRONICS and TELEVISION," and "HOW to READ RADIO DIAGRAMS and SYMBOLS."

Name Age

Address

City State

(Mail in envelope or paste on penny postcard)



Writing with your voice

Years ago Alexander Graham Bell dreamed of "a machine that should render visible to the eyes of the deaf, the vibrations of the air that affect our ears as sound." He never realized that dream, but his researches led to the invention of the telephone.

Today Bell Telephone Laboratories have turned the dream into a fact — translating the spoken word into readable pictures.

By this new invention of the Laboratories, the talker speaks into a microphone. Vibrations of the voice are unraveled through electronic circuits, and then are reassembled as luminous patterns which travel across a screen. Each syllable of sound has a distinctive shape and intensity.



S I E N S U N R A V U L S S P E E T S H

Science unravels speech

Visible speech is still in its infancy, and is not yet available to the public. But educators of the deaf are now evaluating it. Indications are that the deaf can learn to read the patterns and, by comparing the patterns their own voices make with the patterns of correct speech, can improve their diction.

Patterns of visible speech also provide a means for analyzing and recording sound in the study of phonetics and of languages. Eventually, visible speech may make possible visual telephony for the deaf.

This is but one of many contributions by Bell Telephone Laboratories to the understanding and control of sound.



BELL TELEPHONE LABORATORIES EXPLORING AND INVENTING, DEVISING AND PERFECTING FOR CONTINUED IMPROVEMENTS AND ECONOMIES IN TELEPHONE SERVICE

Let Us Show You How to Prepare TO MAKE REAL MONEY QUICKLY!!



EX-G. I.

TEEN-AGE
YOUTH

OLDER MAN

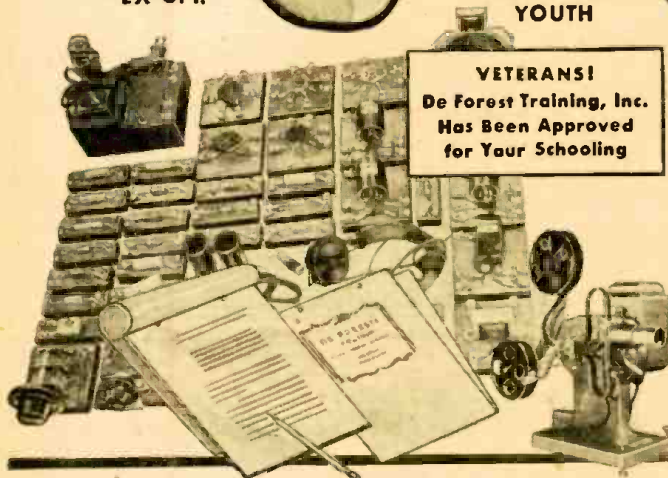

Whether you are an ex-G. I., a teen-age youth, or an older man eager to earn real money...There can be a place for you in The Billion Dollar Field of Electronics and Radio

You will probably find no greater variety of money-making opportunities than in the fields of Electronics and Radio. Hundreds of men, who today either successfully operate their own businesses or hold important jobs in these fascinating fields, are graduates of DeFOREST'S TRAINING, INC.

Our Home Study or Residence courses, thorough in every detail, offer a unique combination of training advantages. We furnish you with a 16 millimeter Motion Picture Projector and 12 reels of valuable movie film. You also use 8 big kits of Radio- Electronic parts as shown on this page, enabling you to work out 133 MODERN EXPERIMENTS for valuable practical experience.

When you prepare to enter the exciting fields of Electronics and Radio, you will want every necessary home study benefit. DeFOREST'S TRAINING, INC. gets you off to a brighter future by supplying these major benefits at home; (1) Learn by Seeing from movies showing radio circuits in action as well as other clearly animated illustrations (2) Illustrated Loose-leaf lessons with handy fold-out diagrams help make our training easy to understand. (3) Learn-By-Doing . . . in your home laboratory you have the opportunity to get real "SHOP METHOD" experience from the many commercial type Radio-Electronic parts you receive. (4) Employment Service . . . after you complete your training, our effective employment service helps you GET STARTED.

DeFOREST'S TRAINING, INC. offers the only Home Study or Laboratory training in the nation endorsed by the New York Museum of Science and Industry, Radio City, New York City.

NATIONALLY KNOWN RADIO STATION CONSULTING ENGINEER RECOMMENDS COURSES OF DeFOREST'S TRAINING, INC.



"Now is the time . . . to prepare to enter the fields of Radio and Electronics . . . no greater opportunity is afforded the high school student . . . the war veteran . . . or the man who is eager to make more money," says Ellery L. Plotts, nationally known Radio Station Consulting Engineer and former Special Research Associate at Harvard University's Radio Research Laboratories. "A study of the DeForest Training, Inc. courses enables me to highly recommend either the Home Study or Residence course."

EX-G. I. STUDENT LAUDS DeFOREST'S EMPLOYMENT SERVICE

"Dear Sir: Due to the fact that I am enrolled in your school, I am now employed by the Westinghouse Manufacturing Company instead of a steel mill. This is a great opportunity for me because this is a new branch opening in this territory and there is a great chance for advancement.



Elmer H. Havens
Lancaster, New York"

DeFOREST'S

TRAINING, INC.

CHICAGO, ILLINOIS

Without obligation, send for our valuable, information-packed book, "VICTORY FOR YOU."
MAIL COUPON TODAY.



DeFOREST'S TRAINING, INC.
2533-41 N. Ashland Ave., Dept. RC-D3
Chicago 14, Illinois, U. S. A.

Send me your big book "VICTORY FOR YOU," showing how I may make my start in Radio-Electronics with your modern home training plan. No obligation.

Name Age
Address Apt
City Zone State
 If under 16, check here for special information.
 If a discharged veteran of World War II, check here.

MARCH • 1947

Editorial: Why Radio Specialization? by Hugo Gernsback 17
 Radio-Electronics Monthly Review 18

Electronics

New Radar for Air Safety (Cover Feature) 22
 Switching and Triggering by Jordan McQuay 23
 Antenna Principles, Part IV—Commercial FM and Television Antennas by I. Queen 30
 Television for Today, Part X—Vertical and Horizontal Synchronizing Circuits
 by Milton S. Kiver 33

Amateur Radio

Working on 50 and 420 Mc. by Edward D. Padgett 35

Servicing

Successful Service Shop by C. J. Whitton 20
 The Postwar Radios—The Belmont Boulevard 24
 Equipping the Shop by Jack King 27
 The 'Scope—A Repair Tool, Part II—Checks on the R.F. Portions of the Receiver
 by Sol Prensly and J. Jacobson 28

Sound

Multi-Station Intercoms, Part I—Master-to-Master Systems by Richard H. Dorf 37

Construction

Dutch Underground Radios by J. Maquerinck 26
 Building a Televiser, Part III—Putting the Video Section Into Operation ... by Roy Freeland 32

Departments

World-Wide Station List Edited by Elmer R. Fuller 38
 Transatlantic News by Major Ralph Hallows 41
 New Radio-Electronic Devices 44
 Radio-Electronic Circuits 46
 Try This One 48
 Technotes 52
 Book Reviews 83

RADIO CRAFT

AND POPULAR ELECTRONICS

Incorporating
 SHORT WAVE CRAFT TELEVISION NEWS
 RADIO & TELEVISION

HUGO GERNSBACK

Editor-in-Chief

FRED SHUNAMAN

Managing Editor

M. HARVEY GERNSBACK

Consulting Editor

ROBERT F. SCOTT, W2PWG

Technical Editor

I. QUEEN, W2OUX

Editorial Associate

ELMER FULLER

Shortwave Editor

ANGIE PASCALE

Production Manager

G. ALIQUO

Circulation Manager

JOHN J. LAMSON

Advertising Director

ALFRED STERN

Promotion Manager

On THE COVER:



Carl Yearian, General Electric engineer, and the Army's AN/APS-10, a light airborne radar.



RADCRAFT PUBLICATIONS, INC. Hugo Gernsback, President; M. Harvey Gernsback, Vice President; G. Aliquo, Secretary

Contents Copyright, 1947, by Radcraft Publications, Inc. Text and illustrations must not be reproduced without permission of Copyright owners.

RADCRAFT PUBLICATIONS, INC. • PUBLICATION OFFICE 29 Worthington Street, Springfield 3, Mass. • EDITORIAL AND ADVERTISING OFFICES 25 West Broadway, New York 7, N. Y. Telephone REctor 2-9690.

BRANCH ADVERTISING OFFICES: Chicago: 308 W. Washington Street, Suite 1413, Chicago 6, Ill. Tel. Randolph 7363. Cleveland: Burdette Phillips, Manager, 405 Erie Bldg., Cleveland, Ohio. Tel. Main 9645. Detroit: Frank Holstein, Manager, 307-8 Boulevard Bldg., Detroit, Mich. Los Angeles: Ralph W. Harker, Manager, 606 South Hill St., Los Angeles 14, Calif. Tel. Tucker 1793. San Francisco: Ralph W. Harker, Manager, 582 Market St., San Francisco 4, Calif. Tel. Garfield 2481.

RADIO-CRAFT, March, 1947, Volume XVIII, No. 6. Published Monthly on 28th of month preceding date of issue. Allow one month for change of address. When ordering a change, please furnish an address stencil impression from a recent wrapper. All communications about subscriptions should be addressed to the Circulation Manager, Radio-Craft, 25 West Broadway, New York 7, N. Y.

SUBSCRIPTION RATES: United States and possessions, Mexico, Central and South American countries, \$2.50 a year; \$4.00 for two years; \$6.00 for three years. Canada, 3.00 a year; \$5.00 for two years; \$7.50 for three years. All other foreign countries, \$3.25 a year; \$5.50 for two years; \$8.25 for three years. Special rates for members of the Armed Forces in U.S., or those addressed by A.P.O. or F.P.O. mail, \$2.00. Entered at Post Office, Springfield, Mass., as second-class matter under the Act of March 3, 1879.

FOREIGN AGENTS: Great Britain: Atlas Publishing and Distributing Co., Ltd., 18 Bride Lane, Fleet St., London E.C.4. Australia: McGill's Agency, 179 Elizabeth Street, Melbourne. France: Brentano's, 37 Avenue de l'Opera, Paris 2e. Holland: Technisch Bureau Van Baerle, Bemelmans & Co., Heemsteedsche, Dreef 124, Heemstede. Greece: International Book & News Agency, 17 Amerikis Street, Athens. So. Africa: Central News Agency, Ltd., 369 Smith Street, Durban, Natal. Universal Book Agency, 70 Harrison Street, Johannesburg. Middle East: Steimatzky Middle East News Agency, Jaffa Road, Jerusalem. India: Magazines Distributors, 5 Bombay Mutual Annex, Gunbow Street, Fort, Bombay 1.

Grasp the **NEW OPPORTUNITIES** in

RADIO ELECTRONICS AND TELEVISION NOW!



Modern Radio — FM Broadcast and Reception — Television — Industrial Electronics; Power, Control, Communications — new equipment and methods demand new technical ability and experience. Keep up to date with the latest.

MODERN RADIO EQUIPMENT FOR YOU TO USE AND KEEP



The very essence of National Shop Method Home Training is **EXPERIENCE**. You get actual experience by working with modern Radio and Electronic equipment—building many types of circuits. You may build a fine, long distance **MODERN SUPERHETERODYNE**, signal generator, miniature radio transmitter, audio oscillator, etc.—many other standard actual operating pieces of equipment—conduct cathode ray and other experiments. This practical work advances your training—**YOU LEARN BY DOING!**

Shop Method Home Training

By a Real Established Resident School with its own FM Studios, Shops and Laboratories.

TRAIN WITH ADVANCED TECHNIQUE

The good jobs in Radio Electronics now go to the men who are equipped to handle them. It takes training and experience. National Schools, one of the oldest and largest trade schools in the country, makes it possible for you to get this training right in your own home **IN YOUR SPARE TIME**.

National maintains modern resident training Studios, Shops and Laboratories where instructors and engineers are working constantly to improve training methods. **SHOP METHOD HOME TRAINING** is a logical extension of this practical system.

A **FREE** lesson that shows you how practical and systematic this new training method is will be sent you without obligation. You may keep and use this lesson to prove to yourself just how practical National Training really is.

Get one of the many **NEW JOBS** that demand new techniques and methods in Modern Radio. Get your share of the **NEW BUSINESS** that servicing the new sets and equipment demands. Experts agree that Radio, Television and Electronics present opportunities

much greater than ever before!

Radio is expanding with far-reaching improvements in reception. No one knows yet how great the Television market will be. Electronics will touch almost every walk of life—in industry and in the home.

TURN YOUR INTEREST IN RADIO INTO A CAREER THAT WILL ASSURE YOU SUCCESS AND SECURITY.

FIND OUT WHAT NATIONAL TRAINING CAN DO FOR YOU

Where do you stand today in modern industrial progress? What does the future hold for you? You owe it to yourself to investigate this opportunity. With National Training **YOU GET AHEAD FAST**—you may step into a good position or start a business of your own, with little capital, even before you complete your National Course.

Fit yourself for a career of independence, good earnings, success and security in one of the fastest growing fields in industry. For full information, just send your name and address on the coupon and mail it **TODAY!**

FREE LESSON

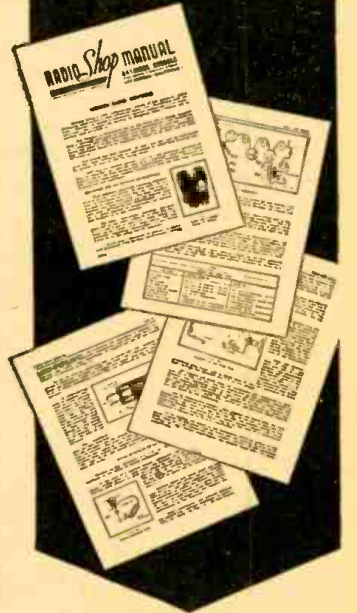

Get This Book FREE

This big book presents the facts about the field of Electronics and your opportunities in it together with full information about the advanced National Training. Read it and make up your own mind that National Training will equip you for a great future. No salesman will call on you from National. The book is **FREE** with your sample lesson. **CLIP** and mail the coupon **TODAY!**



See What National Training Has Done For These Men

National Shop Method Home Training wins good jobs, independence and security. Take the word of National men who have established records in their favorite Radio, Television, or other branches of Electronics.



Clifford Hannah, Portage La Prairie, Manitoba, Canada, writes: "My training has brought results as I'm in line for another raise thanks to National's encouragement and thorough training."

Joseph Michel, Jr., Granite City, Illinois, writes: "I am enthused with National training. I am now earning \$225 a month as a radio operator and technician and \$20 a week more in my shop at home."



From O. K. Ivey, Washington, D. C., comes this endorsement: "I believe National offers the best course to be had ... Keep up the good work."

Here's a statement from R. R. Wright, Blackfoot, Idaho: "Due to my training at National I was selected to instruct in the laboratory work of Navy and Marines."



Read what other enthusiastic students have written about National Training in the big 40 page book we will send you.

NATIONAL SCHOOLS

LOS ANGELES 37, CALIFORNIA EST 1905



MAIL OPPORTUNITY COUPON FOR QUICK ACTION

National Schools, Dept. 3-RC
4000 South Figueroa Street, Los Angeles 37, California

(Mail in envelope or paste on penny post card)

Mail me **FREE** the two books mentioned in your ad including a sample lesson of your course. I understand no salesman will call on me.

NAME AGE

ADDRESS

CITY STATE

Include your zone number

Check here if veteran of World War II



POWER TRANSFORMERS

3200 volts. AC 150 M.A. 115 volt. primary, 60 cycles.

Designed for half wave operation with 150 M.A. output each, two transformers hooked up with secondaries in series and primaries in parallel will give 3,000 volts.

output at 300 M.A. from a full wave rectifier. These are conservative, continuous commercial ratings! \$7.25 Jefferson power transformer 115v 60c/660 vet -85 ma/8.3v @ 7.3a/5v @ 2a/6.3v @ .3a\$3.50 Power supply transformer made by Sub-Sig Pri: 115v 60c. Sec. No. 1: 750VCT @ 115ma. Sec. No. 2: 6.3VCT @ 5 a Sec. No. 3: 5v @ 3a 2500 V test voltage. Specially priced at\$5.95

CHOKES

- 2 hy @ 160 ma. Made by QR 2 for \$1.00
- 12 hy @ 200 ma. Made by Thordarson 2.00
- 11 hy 12 hy @ 150 ma., each price 3.75
- 59 hy @ 100 ma 850 ohms DCR made by Jefferson. Price 2.00
- 2.6 hy @ 800 ma stud and terminals at bottom. Made by G.E. 2.00

Audio Transformer, Modulators, etc.

- Modulation xfmr: typical for 211's cl. A50V ..\$1.35
- Modulation xfmr: 807 to pr 807's 1.00
- Modulation xfmr: pr. 811's to 813 5.00
- Input xfmr: single but mike to grid. 20:1 ratio
- Audio output transformer Split pri. 1500 OHMS each side. Secondary impedance 85 ohms center-tapped -6:1 ratio, 100 watts output 5.50
- Line to Voice coil transformer. Pri 600 ohms Sec 6 ohms. 1200 Test volt 1.25

Hi-Volt Mica Condensers

- F3L .0003 mfd 8000V list \$29.00. \$3.75
- Solar type SX .0015 mf 3000V list \$9.95
- C-D 110 mmf., 10,000 VAC peak. Ceram. Type No. 26921 2.00
- Sankamo G-3 .006 mf 10 kv list \$87.50. 19.50
- .0008 mf 5000 vdc C-D No. 599-6H80
- .0002 mf 5000 vdc Aerovox75
- .0004 mf 3000 vdc Faradon70



PREFERRED POWER PARTS

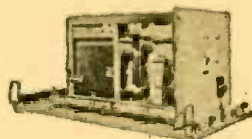

POWER UNIT RA58-A \$116

RA-58-A Hi-Voltage Power Supply

Ideal for breakdown insulation testing, or as a source of power for a pulse transmitter. This unit supplies continuously variable voltages between 500 and 15,000 volts DC at 35 ma. A Voltage Doubler circuit using two 705a rectifiers and two 1 mf condensers is employed. BMS ripple voltage at maximum power is 6%. THIS UNIT OPERATES FROM 115 v/60c. Variable voltage is obtained by means of a Variac in the primary circuit of the high voltage transformer. Size is 21"x17 1/2"x29" deep. Net weight 814 lbs.

B-29 Computer Amplifier, containing 8-JAN6SN7 amplifier tubes. 1-6x5 GT. 8-relays, 5-noon glow lamps, completely wired amplifier circuit with many components. This fine amplifier was designed for use with remote-controlled guns. This buy sells for\$14.75

Power Supply for AN APS-10, using 3-6x5 GT's, and 1-9006, complete with 6 chokes, 1 power transformer, and filter condensers\$6.50

Sonar Sound Detection Unit!

Ideal for detecting underwater sounds, such as fish swimming in schools, with in a 15 mile area. Using a Rochelle salt crystal, which is about 1000 times more sensitive than quartz, as the active unit the sound is transmitted up a 60 ft. length of cable. It is completely enclosed in a solid rubber sheath whose physical size is 1 1/2" L x 2 1/2" dia. This sound detector was originally used in harbor defense. Coupled to an audio amplifier, this can be found to have many valuable applications. Ask for SD-1



\$9.95

Oil Filled Condensers

- G.E., C-D W.E. and other well known brands
- 2 mf 300 vdc \$25
 - 4 mf 300 vdc30
 - 4 mf 400 vdc55
 - 5-5 mf 400 vdc 1.15
 - 2 mf 350 vdc30
 - .25 mf 60 vdc25
 - .85 mf 600 vdc30
 - 1 mf 600 vdc35
 - 2 mf 600 vdc40
 - 3 mf 600 vdc pyr.65
 - 4 mf 600 vdc pyr.70
 - 6 mf 600 vdc pyr.95
 - 8-8 mf 600 vdc 1.49
 - 15 mf 220 ac/800dc 1.50
 - 1 mf 1000 vdc85
 - 2 mf 1000 vdc98
 - 1 mf 1500 vdc 1.05
 - 2 mf 1500 vdc 1.20
 - 2 mf 660 ac/100095
 - 4 mf 1500 vdc 1.33
 - 1 mf 2000 vdc 1.10
 - 1 mf 2500 vdc98

DRY ELECT. COND.

- .500 mf 200 vdc\$1.95
- 2000 mf 50 vdc 2.00
- 4000 mf 30 vdc 2.25

HEAVY DUTY OIL FILLED COND.

- G.E. Pyranol 23F49 1 mf-5000v (list \$27)\$4.75
- G.E. TC-50010 1mf 5000v 4.50
- .15-.15 mf 6000 vdc GE pyranol 26F435 4.50
- .1-.1 mf 7000 vdc GE pyranol 25F435 2.00
- In lots of 50 1.50
- .15-.15 mf 8000vdc Sprague Vitamin Q 5.25
- G.E. 14F191 .1 mf 10,000v Dist (837) 6.75
- G.E. J-1 mf 7000 vdc Pyranol 25F774 4.95
- G.E. .06 mf 15,000vdc pyranol 26F585-G2 5.00
- G.E. .75 mf 20,000vdc pyranol 14F136 18.00



CATHODE RAY TUBES

Made by North American Phillips



- | Tube Type | Your Cost |
|-----------|-----------|
| 3BP1 | \$3.95 |
| 3FP7 | 2.98 |
| 5BP1 | 4.95 |
| 5BP4 | 7.95 |
| 5CP1 | 4.95 |
| 5CP7 | 6.00 |
| 6FP7 | 3.50 |
| 5JP1 | 9.45 |
| 5JP2 | 8.95 |

HI POWER XMTUBES

- 837 1.50
- 872A 2.98
- 705A 6.75
- 241B 40.00
- 861 85.00

Sockets for 5BP1, 5BP4, 5CP1, 3BP1, 705A, 829B and similar types.95c



NEW U.S. NAVY MODEL RAK-7 SHIP RECEIVER \$69.95

15 kc to 600 kc. 6-tube receiver with AVC-Band pass filter-Audio filter-Noise limiter-Precision tuning with a Vernier dial-Voltage regulated power supply, with three tubes, for 60 cycle, 115 volts. Can be battery operated. Complete with spare parts box weighing 73 lbs., tubes and inst. book.

Ohmite Wire Wound Rheostats

- Model H 250 ohms 25 watt \$.89
- Model H 125 ohms 25 watt89
- Model J 225 ohms 50 watt98
- Model J 1800 ohms 50 watt98
- Model K 3000 ohms 100 watt 1.25
- Model L 250 ohms 150 watt 1.98
- Model N 22 ohms 300 watts 2.75
- Model P 1200 ohms 225 watt 2.25

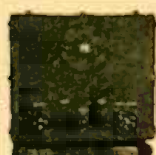

type 84 rectifier tube; shock mounted. Complete with input and output plugs, tube included.\$14.75

RELAYS

- A. S. P. D. T. Leach 1353. 115 V/60 cps. Coin silver contacts. 10A rating. This relay is actually D.P.D.T. with a bridge between the two poles. EASILY CONVERTED TO D.P.D.T.\$1.59
- B. SPDT contacts; coil rated 115v/60 1.39
- C. SPST Latching relay made by Kurman. Make coil 115v/60cps; DCR 1500 ohms. Break coil 115vdc 10ma; DCR 5000 vdc 2.95
- D. DPST Telephone type; 2p, 1 cl; 1 open; cont. rating, 5a at 50v, coil rating 3.5 ma (at 12K ohms), 1000 vac. 1.05
- E. DPDT Steatite insulated 10 amp silvered contacts, made by Leach 1.95
- F. SPDT Struthers - Dunn sensitive keying relay, 5 MA-DC Coil. 110v/60 cycles-2 Amp contacts. 1.49

Cardwell Split-Stator type PK-200-QD. 200-30 mmf per section. Special Hi-Volt with 2" spacing \$9.95 Johnson type 500D35, 500-35 mmf .08" spacing. (Listed at \$11.75)\$4.75



SPECIAL ITEMS

- Tube shields for 2AP198
- Helmholtz phase shifting coil. (360° phase shift) 2.25
- Hook-up wire, stranded, 100 ft.95
- Mycalox strips, 1/4"x3/4"x14 1/2", ea.10
- 12 for \$1.00. Minimum order.60
- Hand generator type GN-45B. Output: 6v-3a/500v-.14a, rated speed 60 cps. 5.95
- Visor for 5" scopes75
- Broadcast band push-button tuning units. Inductive and capacitive types 1.98
- Mushroom earphones to fit any light weight set. Two pairs for98
- Completely punched chassis for 2-inch scope, with some sockets 1.50
- Microphone element T-30-K for throat mike. Sealing 2 for\$.50
- Microphone unit MC-419 for HP mike98
- 140 mmf split stator variable midjet condenser 1.49
- Silver button mica condenser: 175-180-185 mmf, each.05
- In lots of 100 4.53
- Silver button mica condensers: 400 and 500 mmf, each.10
- In lots of 100 9.50
- Feed-through glass insulators 7 1/2" long. Bechtle outside section .. 1.10
- Black crackle finished cabinet for relay rack mounting. 19"W x 25"H x 15"D with hinged door in back 6.00

CW3 Relay Rack Receiver

This superhet receiver will operate on any fixed frequency from 1900 kc to 16,500 kc. Uses 7 tubes. Operating frequency is determined by crystal. With 2 coil groups 5.6-10 mc; 9.5-16.5 mc. Less crystals. Price New at \$27.00

WAVE GUIDE PARTS



MAGNETRONS!! T y p e 2J32 (JAN.) still released. The 2J32 is designed for 10 cm. operation. Rated at 300 kw peak pulse power. Complete information supplied. Brand new, packed in individual protective cartons. The 2J32 is listed at \$200.

Our Price \$25.00.

- 3J31's just received. One cm. magnetron listed at \$95. OUR PRICE \$20.00
- Magnets for magnetrons. Each \$12.00
- KLYSTRON oscillator tubes 2K25/723ab designed for 3 cm operation. New, with complete data. Listed at \$38.00, reduced to\$7.75
- Duplexer using 1B24 for 3 cm \$10.00
- 30 mc oscillator-amplifier with 2 6AC7's. Uses 723ab Waveguide input, xtal detector. With 6AC7's \$10.00
- With 6AC7's and 723ab \$16.50
- Thermistor Beads (D-170396), for use with UHF and Micro-Wave Equipment (List \$3.00). In separate sealed containers95

3 CM wave guide sections

- Silver Plated Directional Couplers with a 20 DB drop with:
- A. 90° bend wave guide 15" long \$4.00
- B. 15° bend in wave guide 15" \$4.40
- C. 30° bend in wave guide 10" long \$3.95
- D. 90° bend in wave guide 15" long also 90° bend in coupler \$5.00

SECTIONS

- E. 2 1/2 foot silver plated with 180° bend (2" radius) \$5.00
- F. 150° bend with 90° twist 3 1/2" radius with pressurizing nipple and coax coupler. \$3.95
- G. 2 1/2 foot 3 cm wave guides choke to cover fitting \$4.50
- H. 5 foot 3 cm wave guide section per foot \$1.95
- J. Slotted dipole antenna 3 cm \$4.00

XTAL FILTER

I-F Crystal filter for BC-312, BC-342. Resonant at 470 kc. Crystal included.\$6.95



COMMUNICATIONS EQUIPMENT CO.

131-C Liberty St., WH 4-7658, New York City 7, N.Y.

All merchandise guaranteed. Mail orders promptly filled. All prices F.O.B. New York City. Send Money Order or Check. Shipping charges sent C.O.D.

TELEVISION-

Does it Hold

A Future

For You?

SPECIAL INVITATION TO WAR VETERANS

With extensive new training facilities under the personal supervision of the famed inventor of the radio vacuum tube, Dr. Lee de Forest, we are able to accept additional applications from Veterans for Television training under the G.I. Bill of Rights. For qualified men who are seriously considering entering a residence school, we have a limited number of Home Study Courses which are available free of charge. Your success with this course will not only help you to decide your own future in Television but will also aid us greatly in qualifying you for residence training.

Send your name and address for your Eligibility Questionnaire. If you qualify under the simple rules, you may start your Home Study Television Course at once and entirely without cost or obligation to you.

American Television Laboratories, Inc.

5050 BROADWAY • CHICAGO 40, ILLINOIS

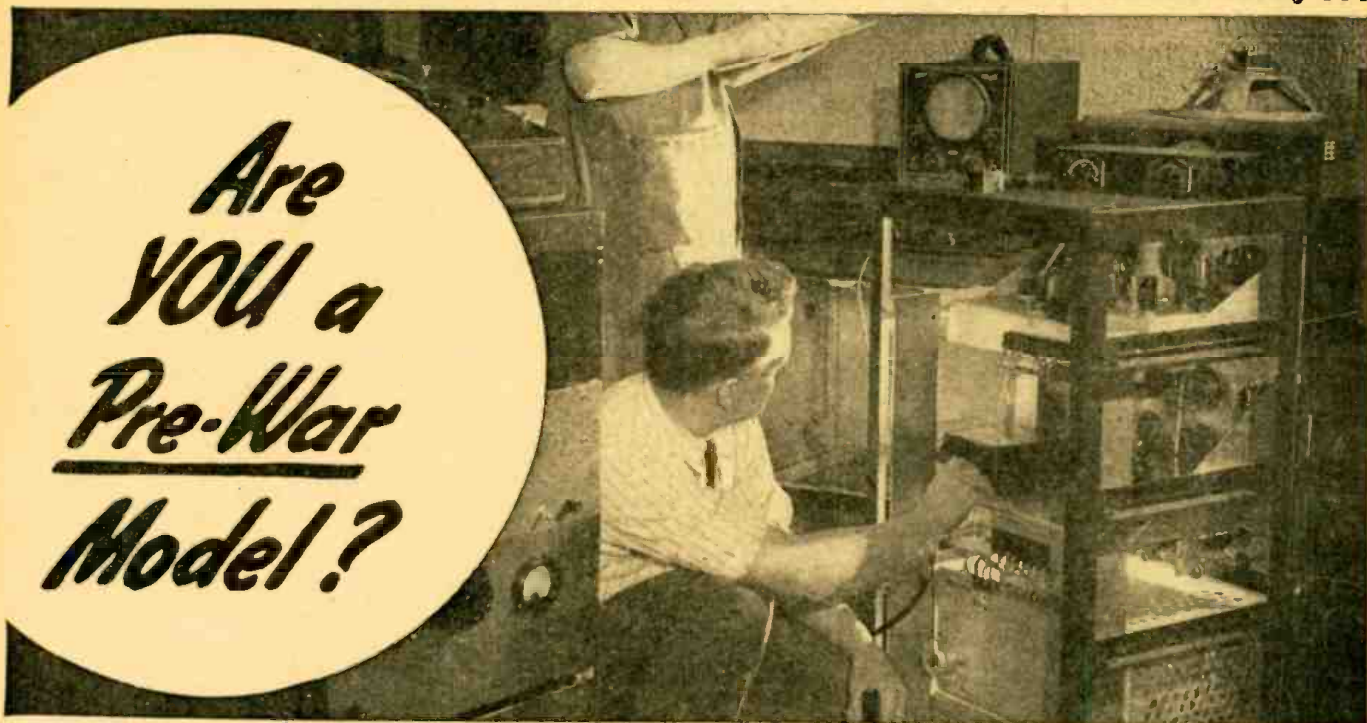

Are
YOU a
Pre-War
Model?

Face the Facts! You Must Keep Up--or Be Left Behind

It's up to you to do something about your future in radio—TODAY! The fight to HOLD good jobs is on . . . the opportunities to ADVANCE are here.

Remember, this new world of radio-electronics demands a vastly increased technical knowledge. No matter what your past or present radio experience has been, you must continue to add to your store of technical knowledge. You must keep up with the new developments and keep ahead of increasing competition, if you expect to get ahead to the better-paying jobs and the comforting security that goes with them.

CREI technical home study training is geared to keep you abreast of the time . . . to provide you with more advanced technical training and the ability to go after and get the better paying job you want.

(CREI training for Veterans is available under the G. I. Bill)

Capitol Radio Engineering Institute

An Accredited Technical Institute

Dept. RC-3, 16th and Park Road, N.W., Washington 10, D. C.

Branch Offices:

New York (7): 170 Broadway

San Francisco (2): 760 Market St.



If you have had professional or amateur radio experience and want to make more money, let us prove to you we have the training you need to qualify for a better radio job. To help us intelligently answer your inquiry—PLEASE STATE BRIEFLY YOUR BACKGROUND OF EXPERIENCE, EDUCATION AND PRESENT POSITION.

**THIS
FREE BOOK
CAN HELP
YOU SEND
FOR IT!**

CREI offers you professionally accepted program of home study training with individual guidance and supervision from a trained instructor. This is the basis of the CREI method of training for which many thousands of professional radiomen have enrolled during the past 20 years, and which has resulted in a large number of promotions to more responsible positions, and larger incomes.

It costs you nothing but a moment's time to send for the interesting facts . . . to learn how CREI can help you obtain the security you want . . . the better-paying job that can be yours.

F. M.

(Forward March)

1947 is but a few months old, but already many of the predicted progress signs have been passed. With FM and Television making extraordinary strides, the demand is greater than ever for adequately trained engineers and technicians. Let CREI be your first step toward getting the better job that is waiting for you.

E. H. Pfeiffer
President of CREI

CAPITOL RADIO ENGINEERING INSTITUTE RC-3
Dept. RC-3, 16th and Park Road, N.W., Washington 10, D. C.
Gentlemen: Please send me your free booklet, "Training for Your Better Job in Radio-Electronics," together with full details of your home study training; I am attaching a brief resume of my experience, education and present position.

NAME

STREET

CITY ZONE STATE

OCCUPATION

I am entitled to training under the G.I. Bill.

SUPERIOR IS AT YOUR SERVICE

with a COMPLETE LINE of TEST INSTRUMENTS



IMMEDIATE SHIPMENT

Please place your order with your regular radio parts jobber. If your jobber does not handle our line, kindly write for a list of jobbers in your state who do distribute our instruments, or send your order to us.

Now you can SEE and HEAR The Signal with the new CA-12 SIGNAL TRACER



Always ready for instant use it takes less than five seconds to begin using this versatile unit. No maze of special cables—the Model CA-12 uses only one connecting cable. No line cord—the CA-12 operates on self-contained batteries. No tuning controls of any kind are used in this model.

Features:

- COMPARATIVE INTENSITY of the signal is read directly on the meter—QUALITY of the signal is heard in the speaker.
- Simple to operate—only one connecting cable—no tuning controls.
- Highly sensitive—uses an improved vacuum-tube voltmeter circuit.
- Tube and resistor capacity network are built into the detector probe.
- Built-in high gain amplifier—Alnico V. speaker.
- Completely portable—weight 8 pounds—measures 5½" x 3½" x 9".

THE MODEL CA-12 comes complete with Detector Probe, test leads, self-contained batteries and instructions. Comes housed in heavy gauge crystalline cabinet with beautiful two tone etched front panel. NET PRICE **\$34⁸⁵**



The New Model 450 TUBE TESTER

Speedy operation—assured by newly designed rotary selector switch which replaces the usual snap, toggle, or lever action switches.

SPECIFICATIONS:

- Tests all tubes up to 117 volts.
 - Tests shorts and leakages up to 3 Megohms in all tubes.
 - Tests both plates in rectifiers.
 - New type line voltage adjuster.
 - Tests individual sections such as diodes, triodes, pentodes, etc., in multi-purpose tubes.
 - Noise-Test—detects microphonic tubes or noise due to faulty elements and loose internal connections.
 - Uses a 4½" square rugged meter.
 - Works on 90 to 125 volts 60 cycles A.C.
- EXTRA SERVICE—May be used as an extremely sensitive condenser Leakage Checker. A relaxation type oscillator incorporated in this model will detect leakages even when the frequency is one per minute. **\$39⁵⁰**



The New Model 670 SUPER METER



A Combination VOLT - OHM MILLIAMMETER plus CAPACITY REACTANCE, INDUCTANCE and DECIBEL MEASUREMENTS

SPECIFICATIONS

D.C. VOLTS: 0 to 7.5/15/75/150/750/1,500/7,500 Volts
 A.C. VOLTS: 0 to 15/30/150/300/1,500/3,000 Volts
 OUTPUT VOLTS: 0 to 15/30/150/300/1,500/3,000 Volts
 D.C. CURRENT: 0 to 1.5/15/150 Ma. 0 to 1.5 Amperes
 RESISTANCE: 0 to 500/100,000 Ohms 0 to 10 Megohms
 CAPACITY: .001 to 2 Mfd. 1 to 4 Mfd. (Quality test for electrolytics)
 REACTANCE: 100 to 27,000 Ohms 13,000 Ohms to 3 Megohms
 INDUCTANCE: 1.75 to 70 Henries 35 to 8,000 Henries
 DECIBELS: -10 to +18, +10 to +28, +30 to +38

The Model 670 comes housed in a rugged, crackle-finished steel cabinet complete with test leads and operating instructions. Size 6½" x 4½" x 2" NET **\$28⁴⁰**

The New Model 600 SET TESTER

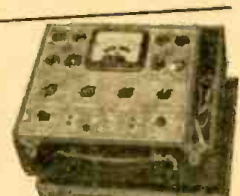

A NEW COMBINATION TUBE TESTER AND MULTI-METER

A complete testing laboratory all in one unit. Test tubes, Reads A.C. Volts, D.C. Volts, D.C. Currents, Resistances and Decibels.

TUBE TESTER SPECIFICATIONS:

- Speedy operation—assured by newly designed rotary selector switch.
 - Tests all tubes up to 117 Volts.
 - Tests shorts and leakages up to 3 Megohms in all tubes.
 - Tests leakages and shorts of any one element against all elements in all tubes.
 - Tests both plates in rectifiers.
 - Tests individual sections such as diodes, triodes, pentodes, etc., in multi-purpose tubes.
 - New type line voltage adjuster.
- MULTI-METER SPECIFICATIONS:
- D.C. VOLTS: (At 1,000 Ohms Per Volt) 0 to 7.5/15/75/150/750/1,500 Volts.
 - A.C. VOLTS: (At 1,000 Ohms Per Volt) 0 to 15/30/150/300/1,500/3,000 Volts.
 - A.C. CURRENT: 0 to 1.5/15/150 Ma. 0 to 1.5 Amperes.
 - RESISTANCE: 0 to 2,000/20,000/200,000 Ohms 0 to 20 Megohms.
 - DECIBELS: (Based on zero decibels equals .006 Watts into a 500-Ohm line.) -10 to +18 D.B., +10 to +38 D.B., +30 to +58 D.B.
- NET **\$62⁵⁰**

The New Model 650 SIGNAL GENERATOR

RANGES:

- 100 Kilocycles to 35 Megacycles on Fundamentals.
- 25 Megacycles to 105 Megacycles on Harmonics.

- RF obtainable separately or modulated by the Audio Frequency.
 - Audio Modulating Frequency—400 cycles pure sine wave—less than 2% distortion.
 - Attenuation—3-step ladder type of attenuator (T pad).
 - Uses a Hartley Excited Oscillator with a Buffer Amplifier.
 - Tubes: 6J5 as R.F. Oscillator; 6SA7 as modulated Buffer and Mixer; 6SL7 as audio oscillator and rectifier.
- Complete with coaxial cable, leads and instructions. NET **\$48⁷⁵**



The New Model 400 ELECTRONIC MULTI-METER

A COMBINATION VACUUM-TUBE VOLTMETER AND VOLT-OHM MILLIAMMETER PLUS CAPACITY, INDUCTANCE, REACTANCE AND DECIBEL MEASUREMENTS

Specifications:

D.C. V.T.V.M. VOLTS: (At 11 Megohms Input Resistance) 0 to 3/15/30/75/150/300/750/1,500/3,000 Volts.

D.C. VOLTS: (At 1,000 Ohms Per Volt) 0 to 3/15/30/75/150/300/750/1500/3000 Volts.

A.C. VOLTS: (At 1,000 Ohms Per Volt) 0 to 3/15/30/75/150/300/750/1500/3000 Volts.

D.C. CURRENT: 0 to 3/15/30/75/150/300/750 Ma. 0 to 3/15 Amperes.

RESISTANCE: 0 to 1,000/10,000/100,000 Ohms; 0 to 1/10/1,000 Megohms.

CAPACITY: (In MFD) .0005—2, .05—20, .5—200.

REACTANCE: 10 to 5M (Ohms), 100—50M (Ohms), .01—5 (Megohms).

INDUCTANCE: (In Henries) .025—14, .35—140, 35—14,000.

DECIBELS: -10 to +18, +10 to +, +30 to +58.

NET **\$52⁵⁰**



SUPERIOR INSTRUMENTS CO.

Dept. RC 227 FULTON ST., NEW YORK 7, N. Y.

SPRAGUE TRADING POST

SWAP - BUY - SELL

FOR SALE—No. 19 Mark II (Zenith) 15-tube Xmtf-Receiver. Compl. with dynamotor, antenna, 5 sets phones and mikes, key, spare parts, mkt. rack, spare set tubes. T. J. Geiselhart, 318 Laurel Place, E. Rutherford, N. J.

WANTED—New or used HT-6 xmitter in good condition. W. O. Eden, 10508 N. Island Ave., Ant. 6302, Portland 17, Ore.

FOR SALE—National 1-10 receiver with home-made supply and tubes. Almost new. Sidney Warren, W3GFV, 2550 S. Darien St., Philadelphia 48, Pa.

SELL OR SWAP—185 QST's 1921-1945; relays, meters, tubes, etc. What have you? What do you need? W8BSS, 14904 Alder Ave., E. Cleveland, Ohio.

SALE OR TRADE—One original Vibroplex bug, new. One new 100th. One Instructograph Sr. With two international tapes and five Morse. A-1 Radio Service, Selah, Wash.

WANTED—Past issues of Radio News, Radio-Craft, Radio & Television. Write for list. Will exchange current British hooks or postage stamps. A.V.J. Marsh, 16 Lusley St., Newport, J.O.W., England.

FOR SALE—Stromberg-Carlson marine amplifier. 50-watts output. H. Payne, 2640 W. 56th St., Seattle 7, Wash.

SWAP—Emerson BM-206 5-tube; Philco Jr. Superhet model 80 4-tube; and I.C.A. Short Wave 2-tube converter. All Okay Will trade for short-wave receiver ranging from 5 meters up. Mr. & Mrs. Chas. F. Senker, Sr., 4301 Forest View Ave., Baltimore 6, Md.

SELL OR SWAP new Gen. Electric dynamotor, never used, 28v DC input, 1950v DC at 350 ma. output. Want ham gear. What have you? F. Schachtel W9IFS, 608 So. 94th Place, Milwaukee 14, Wis.

FOR SALE—Signal Corps R-100 receiver AC-DC Batt., 115/230 V., 550-1500 KC. 3.6-8.5 MC. 8.5-19 MC. speaker & phono output. \$75. Thomas F. Stenson, 520 E. 77 St., New York 21, N. Y.

FOR SALE—G-E tube tester TCP-3 new, portable, tests all tubes. \$50. Howard No. 430 comm. receiver, 5 bands, \$35; Federal recorder, semi-pro model, dual speed, radio tuner, 2 mike inputs, 10" Jensen speaker, portable, \$250. All F.O.B. F. U. Dillon, 1630 N. La Brea Ave., Los Angeles 28, Calif.

FOR SALE—Italian Phillips miniwatt EF9 and P19r Italia 6AW9 tubes, one of each. L. Wheeler, 710 W. 21st St., Vancouver, Wash.

FOR SALE—Amertran Precision deluxe reactors, L244CB. 350 henries at 5 ma. Triplet alloy cases. \$2 ea. Also UTC, L894 reactors @ \$3 ea. M. S. Schaefer, 280 Wadsworth Ave., New York, 33, N. Y.

FOR SALE—Wire recording unit, compl. with motor, wire, head and erase coil. Less amplifier. \$15. D.M. Cox, 203 N. West Ave., Kankakee, Ill.

FOR SALE—Entire radio shop stock. Most go at less than net. Also other items at bargain prices. Write for details. Eddie Howell, Route No. 2, Dillon, S. C.

FOR TRADE—6AC7, 6SJ7, 6L6 tubes; 10", 7" and 5" dynamic speakers for wind-up UDe portable phonographs. Paul Dyer, 120 Spring St., Newton, N. J.

FOR SALE—Latest model RCA Chanalyst; Hickok No. 18 slt. generator; Triplett 6668 V.O.M., Philco V.O.M. and over 600 hard-to-get tubes in sealed cartons. Also RCA 16mm sound projector and AC ¼, 1/3 and ½ h.p. motors. Write for details. Joe's Radio Lab., 30 Wall St., Passaic, N. J.

WILL SWAP—NC 81X, C-Brenko Bridge, Precision EV 10 VTVM less meter, Triplett 6668, all types new meters, EL inverter, xmitting and receiving tubes, etc. Want wire or professional recording eqpt., scope or hi-fi amp. George Hoffer, 1275 Neilson Ave., Bronx 52, New York.

WANTED—Rider's manuals 1-9 incl. Any or all. All replies answered. J. M. Francis, 1660 Larchmont Ave., Lakewood, Ohio.

FOR SALE—Dynamotor F/BC 312 at \$2.25; PE103 dynamotor F/SCR 284, \$8.50; PE73 dynamotor F/BC191, \$6.25. Write for list. Mrs. Joyce Sellatt, 613 W. Spring St., Lima, Ohio.

WANTED—Oscilloscope, Dumont or RCA; UTC trans. LS 55, HA 107, commercial transcription turntable, relay racks, Variac, Powerstat, Solo or similar AC control or regulator, Lab C/R bridge 1%. Will buy or swap. George Fried, 1015 Washington St., Hoboken, N. J.

FOR SALE—New Triplett No. 2314 tube tester, \$45; No. 900 Vomax, \$50; No. 203 Hickok electronic volt ohm capacity milliammeter, \$70. Used very little. Also Rider manuals, tubes, parts. Write for list. Henry W. Hubbard, 1800 D St., Baker, Oregon.

FOR SALE—Used comb. tube checker and set tester No. 1280 (Superior). \$25. Randall Paul, Box 73, Killeen, Texas.

WANTED—Good used signal generator, also a watt meter. Gus A. Dulibaek, 409 N. Adams St., West Frankfort, Ill.

SOMETHING NEW IN SPRAGUE ATOMS

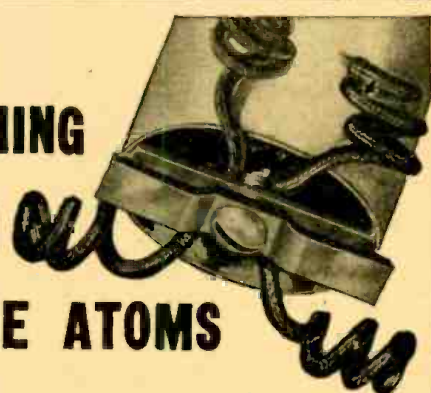

The Handiest Dry Electrolytic Capacitors for Vertical Chassis Mounting

These unique Sprague Type LM Atoms with their universal mounting feature are just the thing for replacing inverted can, spade-lug or other types of vertically-mounted capacitors. They fit any chassis hole from 3/16" to 7/8" diameter. Special clamps fasten securely to the chassis in an instant. Separate positive and separate negative leads can be connected together to get common positive or negative sections. Ideal for replacing old common positive section capacitors because section-to-section electrolysis is eliminated. Available in popular capacities at leading jobbers. Ask for them by name—Sprague Type LM's!

FOR TRADE—Have Thordarson 2099 power choke and ditto 2098 power transformer over 600-600v with 7.5v filament; also 3 General Radio double impedance couplers No. 373. Want AC amplifier of 6W push pull or gas engine, 1 to 2 h.p. W. Oswald, 1431 Englewood St., Philadelphia 11, Pa.

FOR SALE—New G-E Oscilloscope CRO-3A, \$75; Latest model Melsner analyst, \$100; Radio City counter tube checker No. 312 checks up to 117v tubes, \$40. Frank Frasca, 13 N. Bond St., Mount Vernon, N. Y. Make all inquiries by mail.

FOR SALE—New Hickok No. 203 electronic v-o-m, \$75 cash or will trade for new tubes and parts of equivalent value. E. Sujak, 4200 Elston Ave., Chicago 18, Illinois.

FOR SALE—Back issues of QST: 1-1926; 4-1927; 1-1928; 3-1929; 12-1930; 1-1931; 5-1932, total 37 issues. Also have 1930 and 1934 Handbooks. \$4.75 takes all. Good condition. Dave's Radio, 1310-42nd St., Brooklyn 19, N. Y.

FOR SALE—Wurlitzer console with set of records & name tabs, \$275; Remington Hand dry shaver with case, \$17.50; Stark battery type tube tester, \$40; Automatic record player, \$35. Want recording eqpt. or what have you? Send for list. Pleasant Valley Radio Service, Armstrong, B.C., Canada.

WANTED—Hallcrafters SX-25 or SX-32 used or new, without speaker. R. A. McNeill, Cowley, Alberta, Canada.

WANTED—Radio receiving tube 25B8. Cash. Ernest Cook, South Fallsburg, N. Y.

FOR SALE—Navy model LM frequency meter. Makes good V. F. O. or signal generator. John W. Meyers, B. D. No. 6, Applestrove Road, North Canton, Ohio.

FOR SALE—Radio parts, new or like new, such as condensers, sockets, dials, knobs, rheostats, transformers, chokes, jacks, all first quality material. A bargain for \$15 cash or express. C.O.D. Ceall R. Hockenberry, P. O. Box 205, Slippery Rock, Pa.

FOR SALE—SX-28A Hallcraft receiver in A-1 condition, with PM speaker, \$195. S. Palasek, 62 Main St., Port Washington, N. Y.

BUY, SELL OR TRADE hard-to-get radio parts. Let me know what you have to trade or want. Peter Wnukowski, 334 Rideau Ave., Kingston, Pa.

FOR SALE—Million model DF tube tester, good condition (chart worn, but included) \$15. Readiite multimeter No. 710-A in good shape, \$10. C.O.D. or cash. Cheney Electrical Service, Box 108, Nora Springs, Iowa.

FOR SALE—Echophone, \$20; Coyne Troubleshooter Manual; Coyne Reference Encyclopedia (3 vols.); Audels Electrical-Mechanical Dictionary; Marine Radio Manual; Heleus Tubes; Speed Signal Tracer; RCA 171 Station Allocator, etc. B. Rosenberg, 1346 Park Rd. N.W., Washington 10, D. C.

FOR SALE—Racon giant units, genemotor, 300 used tubes, John J. Levine, Carr Elec. Products Co., 15-17 Kelley Square, Worcester 4, Mass.

FOR SALE OR TRADE—Radlart Vibrapack Type 4200 D.F., 12v input, about 100 ma. output 250v., less tube, used little, \$4.50. Also reflex projector horns less drivers. Walter Blomdek, Wickatunk, N. J.

WANTED—N.R.I. tester, all-wave, all-purpose tester Model 1175A or 1175B made for National Radio Institute. Also want other test eqpt. Wilson Radio Service, Bedford City, Va.

YOUR OWN AD RUN FREE

The Sprague Trading Post is a free advertising service for the benefit of our radio friends. Providing only that it fits in with the spirit of this service, we'll gladly run your own ad in the first available issue of one of the six radio magazines in which this feature appears. Write CAREFULLY or print. Hold it to 40 words or less. Con-

fine it to radio subjects. Make sure your meaning is clear. No commercial advertising or the offering of merchandise to the highest bidder is acceptable. Sprague, of course, assumes no responsibility in connection with merchandise bought or sold through these columns or for the resulting transactions.

Send your ad to

Dept. RC-37, SPRAGUE PRODUCTS COMPANY, North Adams, Mass.

(Jobbing distributing organization for products of the Sprague Electric Co.)

ASK FOR SPRAGUE CAPACITORS and *KOOLOHM RESISTORS by name!

*Trademark Reg. U.S. Pat. Off.

WHY RADIO SPECIALIZATION?

Generalization Must Be Thorough Before Specialization

YOUNG men—today as of old—are puzzled how best to proceed in their chosen field in order to succeed in a minimum of time.

For many years a continuous stream of young men—college men and others—have come to me in person, or have written me for a formula to success, to apply to their own individual problem.

Frequently, I have advised—speaking in a broad manner—that in my own estimation, the best way to succeed today lies in specialization in a given endeavor.

This advice sometimes leads to misinterpretation. For that reason I print here the letter of a young college student for a better understanding of the problem:

Rutgers University
New Brunswick, N. J.

Dear Mr. Gernsback:

In your letter of the 9th you stress the fact that, "in order to succeed these days, people must be specialists." I recall that after our first talk, some time ago, I left you, deeply impressed by what you had said regarding specialization.

There is, however, another school of thought, and that is, generalization. Today, educators maintain that for a man to succeed in the *engineering profession* his schooling should be as general as possible and cover the different branches of engineering. Thus, I, who am enrolled as a student of Electrical Engineering, am taking courses in Mechanical and Civil Engineering. This teaching procedure is believed to be the best one because men who are in industry say that the engineer constantly meets problems which necessitate a knowledge of all the branches of engineering and therefore the engineer should have a wide scope of knowledge. In essence, the engineer should be able to cope with any problem he meets.

It appears that the large companies such as General Electric and Westinghouse, for instance, realize the impossibility of teaching a student all he should know. These large companies have established their own schools where the subject matter directly connected with Electrical Engineering is taught. However, young men who are employed by smaller firms become specialists *only* after a long time working at one thing.

I believe I have presented the other side of the case, and while I lean towards your side, that is, specialization, I should like your views on the solution of the problem of "Specialization or Generalization as it Concerns the Student."

THEODORE BAER.

Here we have an ambitious young man who—according to a previous talk with me—wants to get into the radio profession after his graduation. In our talk, I mentioned the fact that the men most apt to succeed these days are those who *specialize*. I pointed out that the term "radio" today is so vast that there is not alive a single individual who can truthfully say that he fully knows every last ramification of the art. Radio, or Electronics—they are almost identical—have grown so rapidly, particularly during World War II, that even the best radio engineers have great difficulty in keeping abreast with the subject. This does by no means imply a thorough study of each and every new item, but rather a hasty reading of it.

I went to some pains to point out that even in a single branch of radio, the subject has grown to large dimensions. Take any branch—tubes, radio receivers, public address, television—all are vast domains of learning and research. You *have* to be a specialist to succeed in any of them. Take even a sub-branch—microphones.

We knew a man—he's only in his early 40's today—who once told us he'd specialize in "mikes" only. That was twenty years ago. He said that in due time "he'd know as much or more about mikes than anyone else ever did." He kept that promise. He is today one of the most successful microphone manufacturers in the field. It is still his first love and while he makes one or two other radio items, the microphones manufactured under his patents and designs are by far the bulk of his business.

A former editor of mine chose to manufacture variable condensers. His name is Samuel Cohen. Today he is the chairman of the board of the General Instrument Corp.—the world's largest variable condenser producers, doing a business of many millions of dollars annually. We could name many others similarly successful manufacturing "single" items only—public address, tube sockets, inductance coils, resistors, etc.

This is what is meant by specialization. We also realize that a young radio man who has no financial backing does not very often embark upon the manufacturing business at the age of 21. Nevertheless, specialization applies to him too.

Given a *THOROUGH* education in electricity and radio, sooner or later he discovers that he has a penchant for a certain radio or electronics branch. Continuously we see young men who excel in radio set building, sound, servicing instruments, amateur transmitters, aerial design, microwaves, and dozens (Continued on page 78)

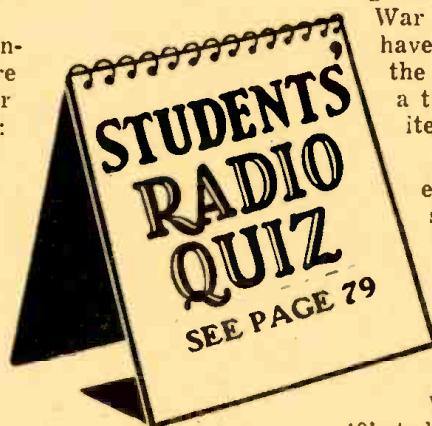

RADIO-ELECTRONICS

Items Interesting

MAGNETIC DISC RECORDS on paper no thicker than ordinary type-writer bond were demonstrated by the Brush Development Co. last month. Known as *Mail-A-Voice*, the new equipment is designed chiefly for business correspondence between firms equipped for it, but has a host of non-communications uses, among which may be included study of foreign languages, recording one's own voice for speech culture, and logging parts of radio transmissions.

The record may be mailed like any other piece of paper, but the folding



Magnetic paper disc recorder, portable model.

must be done *before recording*. Records may be erased and re-recorded several thousand times, if desired, or may be filed for permanent reference. Each of the records plays for three minutes. Cost is about 7 cents each.

Fidelity of the machine is suitable for speech only. A single crystal unit acts both as microphone and receiver. Three tubes are used in the amplifier. Recording is at 40 lines per inch, *inside-out*, and the recorder operates at 20 revolutions per minute.

Spectators at the demonstration wondered what means were used to keep each line of recording within its own "groove." The answer is simple. No means are used. The magnetic field spreads to both sides of the recording line, but falls off in strength on each side so rapidly that with ordinary amplification, "adjacent-channel interference" is inaudible.

TELEVISION was used by President Truman to view the opening session of the House of Representatives January 3. A televisior was so installed that the President was able to view the proceedings from his White House desk. The President's look-in on Congressional activities was only a part of a larger broadcast, in which viewers in Washington, Philadelphia and New York were able to see and hear the opening session and pre-opening interviews with House leaders. This was the first time that any Congressional event has been televised.

INDUSTRIAL TELEVISION has been successfully used for the first time, in the Hell Gate Station of the Diamond Power Specialty Corporation of Detroit, Michigan. The television instrument is a *Utiliscope*, which shows an exact picture of some remote or inaccessible point on a screen similar to that of a home television receiver.

According to a report issued last month by Farnsworth Television and Radio, manufacturers of the instrument, the *Utiliscope* has been in practical operation for the last nine months, and has been proved a practical success. It is used to show the water level in a boiler remotely located from the main control room. A photo-electric camera focused on the water-level gauge continuously transmits the picture to the associated control panel where the 200-line image is reproduced on a television screen.

This permits observers in the control room to keep a constant check on the boiler 325 feet away. Not only are the boiler and main control room separated by a distance greater than an average city block, but also by eight floors, a building wall and various other obstructions.

Gauges on large boilers such as the one at Hell Gate must be under direct visual surveillance at all times, because expensive damage can be caused if water in the boilers rises too high or drops too low. Lofty heights of the boiler drums and line-of-sight obstructions such as galleries and piping often make direct surveillance of gauges difficult for workers, but the *Utiliscope* has solved this problem in a completely satisfactory manner.

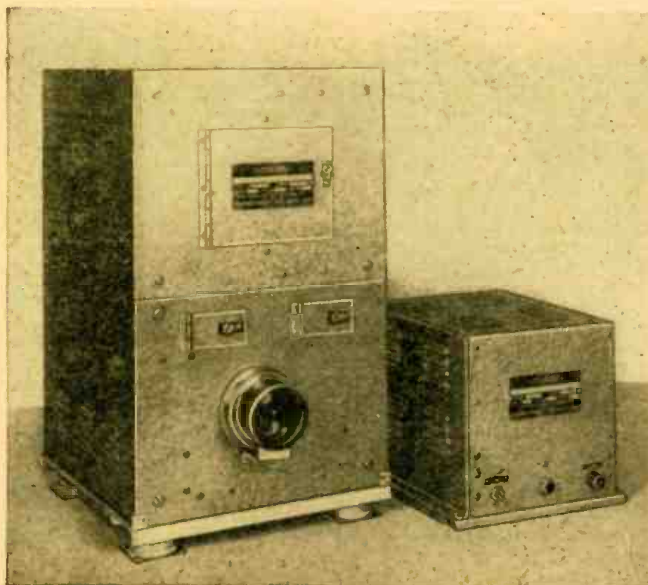

A practical industrial-type television equipment, the *Utiliscope*.

TWO MILLION FM RADIOS will be manufactured in 1947, stated R. C. Cosgrove, president of the Radio Manufacturers' Association, to a meeting of marketers in New York City last month. This would be a tenfold increase over 1943 production.

Stating that radio prices were too high, he said. "With or without FM, good table models will sell for an average of \$50 and consoles will run from \$175 to \$200."

The Cosgrove statement came almost simultaneously with a report that FM broadcasters in new areas are hard hit by the shortage of receivers, and are broadcasting to audiences which approach zero. The new FM association is attempting to secure the co-operation of manufacturers in channeling sets to cities where FM stations are suffering from a lack of audiences.

CONSOLE RADIOS continue hard to get. The demand still far outruns the supply, a check-up last month by *The New York Times* revealed. Table models, says the report, have made considerable gains in stocks and are available for immediate delivery in many types.

Console radios were bracketed with electric refrigerators, washing machines and other large household equipment as being in short supply, while electric irons and clocks compared with small radio receivers in increasing availability.

IONOSPHERIC RESEARCH carried on by the Bureau of Standards will receive considerable assistance from amateur radioists at widely-scattered points on the earth, according to a release from the Bureau last month.

The amateurs, 130 in number, will participate in a project to collect data on high-frequency transmission and reception, which is especially concerned with the study of "sporadic-E" phenomena. They will make regular reports on conditions in the ionosphere. Necessary equipment will be supplied by the Bureau. The observers are well spread out over the globe, covering even such out-of-the-way spots as the Aleutian Islands and the Malay Peninsula.

MONTHLY REVIEW

to the Technician

RALPH R. BEAL, vice president in charge of engineering of RCA Communications, Ltd., died suddenly January 24, 1947, at the age of 59.

Mr. Beal was a pioneer in radio, television and electronics. As a field engineer in the early days of radiotelegraph communication, he participated in the first investigations into high-power point-to-point radio transmission and contributed toward the development of the art into a dependable means of world-wide international communication. Later, as Research Director of the Radio Corporation of America, he was given the responsibility of coordinating research and advanced engineering development activities of the company and its subsidiaries.

Serving as Research Director from 1934 to 1943, Mr. Beal originated and supervised programs of research which constantly broadened the field of radio products and services.

ATOM-SIZE TRANSMITTERS of radio waves were described last month in a report on a new system of radio analysis by Drs. Felix Block, William Hansen and Martin Packard of Stanford University. In the new technique the nucleus of an atom is turned into a miniature radio transmitter, sending out a signal that identifies the atom.

Amplified radio frequencies reproduced on an oscillograph screen show the observer what frequency the atom responds to. Each element has a characteristic frequency to which it resonates in a magnetic field under the influence of radio-frequency current.

Test materials are first placed in tiny glass vials in the field of a powerful electromagnet. Spinning the vials in the magnetic field induces a radio-frequency current into the nuclei of the atoms. When the nuclei are spinning at right angles to the field, the frequency of the signal from the atom can be determined by a sensitive receiver, revealing the identity of the element.

The nucleus of a hydrogen atom, a proton, will whirl as fast as 42,500,000 times a second in a powerful magnetic field. Dr. Bloch has been using protons in his testing which has revealed the hydrogen in solution or in paraffine.

The technique is not yet considered ready for practical scientific work.

This method of analysis contrasts with that described in *RADIO-CRAFT* last month, in which material to be analyzed is bombarded with microwaves and absorbs power from the transmitter at the resonant frequency of its atoms. The atoms act as receivers rather than as transmitters in that system.

DR. LEE DE FOREST was presented the Edison Medal of the American Institute of Electrical Engineers on January 28. In the words of the citation, the award was made: "for pioneering achievements in radio and for the invention of the grid-controlled vacuum tube with its profound consequences."

The medal, one of the two high annual awards of the Society, was first presented in 1910, to Dr. Elihu Thompson. Since then it has been presented to many leading figures in both the electric and the radio-electric fields. Among recipients of the honor during the last few years, radionics will recognize E. F. W. Alexanderson, Edwin Armstrong and Vannevar Busch.

Dr. de Forest's acceptance speech follows. Since part of it parallels his article in the January *RADIO-CRAFT*, it is reproduced in condensed form:

In my youth I learned a Bible verse which read, "If ye have faith, all these things shall be added unto thee," which in my case I found should be thus supplemented—"faith, plus longevity!"

I am happy, indeed, today to be so fortunate as to have lived to realize one prize to which I had long aspired, the great honor which your Committee has bestowed upon me, the Edison Medal. The Laurel is better late—than posthumous.

From early boyhood, Thomas A. Edison was my ideal, my living inspiration, my idol. My ever present ambition was to be able to achieve something, sometime, which might be compared with his incandescent lamp or his phonograph, a thing revolutionary in nature, applicable to the needs of a continually unfolding, and an ever-developing society.

Commencing almost with the beginning of the wireless telegraph, I sought to apply to that new enterprise my newly acquired knowledge of Hertzian waves, their generation and reception. Because I had to build my own equipment, I perforce concentrated on a new wireless detector for it was cheap to construct, and for experiment.

I became firmly convinced that the Hertzian waves, or their derived cur-

rents, could be made to affect the conductivity of gases, with electrodes heated to incandescence therein. Three years later I proved that my idea was well founded when wireless telegraph signals were received with a Bunsen burner detector in whose flame were two platinum electrodes, one of them incandescent. A slow evolution from this stage brought me, in 1906, to the so-called Audion, described in a paper presented that summer before a New York session of the Institute.

In the summer of 1906 the Audion (as my assistant, Babcock, cleverly named it) embodied the elements of the flame detector, heated cathode, relatively cold anode, local battery, and signal indicator. The control electrode was next added, first in the simple form of a strip of tin foil wrapped around the tube. This was primarily to increase the sensitivity of the device by preventing any shunting of the received energy through the anode-to-earth path. Prior to that the antenna lead, or its equivalent, had been connected directly to the anode.

This crude control electrode proved a definite improvement. Successive steps in increasing sensitivity of this new detector: placing the control electrode in the form of a plate, like the anode within the envelope, but on the opposite side of the filament cathode; next this electrode located between the cathode and anode in form of a perforated plate; and finally, for simplicity of construction, a short piece of platinum wire bent in the form of a grid. This last step was late in 1906.

The Audion until 1912 remained only a detector of wireless signals, happily by far the most sensitive detector existent, as proven by the ever-increasing eagerness of the then "hams" to acquire one of these coveted bulbs by hook, crook—or purchase if need be—at a fabulous cost of \$8.00, with filament life unguaranteed, but hopefully of the order of thirty hours!

(Continued on page 75)



Very recent photograph of Dr. Lee de Forest, taken as he and Hugo Gernsback look over the Audion Anniversary number of *Radio-Craft*.

SUCCESSFUL SERVICE SHOP

By

C. J. WHITTON

RETURNING servicemen have not been the only ones hard hit by the dislocation following the war. When war was declared, I closed up my shop, sold my equipment, and went into an aircraft plant. No, I wasn't dodging the draft—I was too old to make a good soldier but not too old to work. In mid 1945, when I decided to venture again into the business world, I determined to try virgin territory and set sail for Texas.

My wife and I arrived in Denison with \$1,000 (the fortune I had amassed in four

years of aircraft work) and a 1936 automobile. We could not find an unoccupied building in town, so we presented our plans and an outline of our methods of doing business to one of the local banks and requested financial aid in constructing our own building. The bank was willing to finance not only the building but also agreed to advance part of the money necessary for our proposed stock and equipment.

The result was the little building shown in the photo. Small enough to be built within our available means, it was purposely designed so that future additions could be made if expedient. The building is unique in that it was designed from floor to roof for the sale and service of radio.

As soon as construction on the shop was started, we contacted a local printer and had the letterhead illustrated here prepared. We then wrote to each of the distributors and suppliers in our locality and explained that we were in the process of building and would need cer-

Below is a sample of the job sheet. Sticker shown is pasted inside the radio and refers to sheet series number

NAME: Doe, J. D. ADDRESS: 527 Blank St. PHONE: 4474

MAKE: Emerson MODEL: 30 SERIAL: 221

ESTIMATE: 43 Tube Shorted on #4 Rest of Tubes OK.

WORK DONE:

5/10/46 DATE RECEIVED

5/11/46 ESTIMATE PROMISED

5/11/46 NOTIFIED

5/11/46 ESTIMATE APPROVED

5/13/46 WORK PROMISED

5/12/46 WORK COMPLETED

5/12/46 NOTIFIED

5/13/46 DELIVERED

5/12/46 INVOICE POSTED

REMARKS: MOD

TEXOMA RADIO COMPANY
"Denison's Complete Service Store"
178 W. CHESTNUT PHONE 2450

PAID MAY 13 1946

ON HAND	ORDERED	RECEIVED	USED	DATE	ON HAND	ORDERED	RECEIVED	USED	DATE
15									
13		2		2-25					
12		1		7-1					
9		3		3-5					
7	6		2	3-10					
13		6							
12		1							
9		4							
7		7							

Inventories kept up-to-date are aids to success in business

Sample circular as mimeographed on the regular letterhead

Corner of the service bench, showing the shop's equipment.

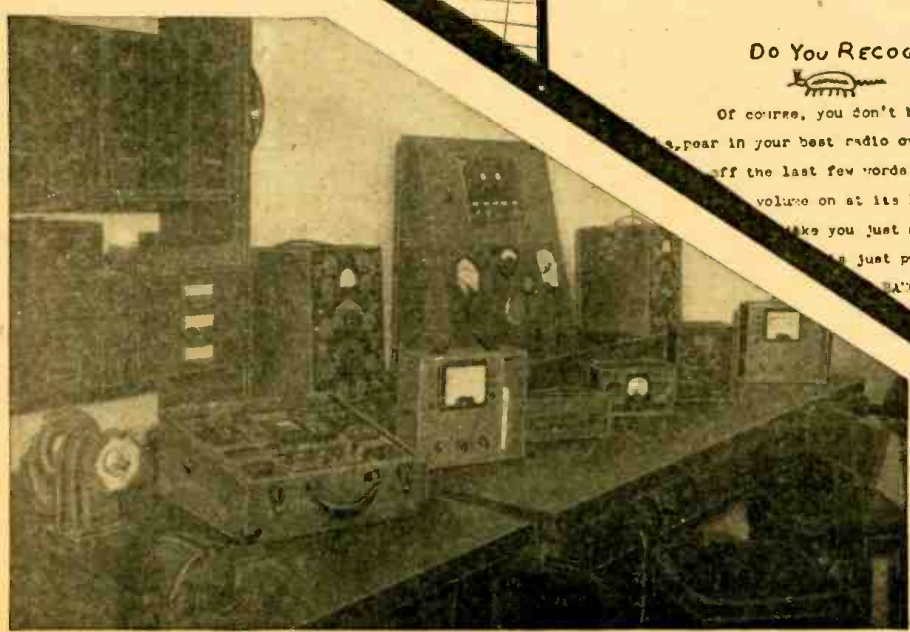

Sales: HELIX RADIOS, MARCO AMPLIFIERS, ELECTRIC APPLIANCES, PARTS FOR THE BUILDERS. PHONE 2450

Service: ALL MAKE RADIO REPAIRS, AMPLIFIERS, SMALL APPLIANCES, RECORD CHANGERS. PHONE 2450

TEXOMA RADIO COMPANY
"Denison's Complete Service Store"
178 W. CHESTNUT DENISON TEXAS

DO YOU RECOGNIZE THESE BUGS?

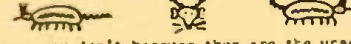

Of course, you don't because they are the unseen bugs that appear in your best radio overnight. They're the guys that always off the last few words of "Bob Hope's" funniest gag, then volume on at its loudest so you can hear everyone else like you just missed. Or, on Sunday morning, your just putting the finishing touches to a very by the time you have shook and the unnumberable kidding places, you Junction, singing "Mama I'm

ing these bugs, namely: quality repair parts" CONPLI-CONEIL.

Idea on opposite page photo is worth copying. Customer can see his radio but cannot breathe down back of serviceman's neck.

The Texoma shop is a rarity in architecture, built especially for radio service



tain specified parts and equipment on or before our opening date. As a result, we had new equipment throughout and a representative stock of tubes and parts valued at \$600 when we opened on March 1, 1946. Within three months this stock was approximately doubled. Much of this early success was due to the "good, first-class letterhead" (RADIO-CRAFT editorial, November, 1945) and, of course, reasonably well-written letters.

We felt that a neat letterhead would be as impressive to our customers as to manufacturers or distributors, and had our printer duplicate the letterhead on cheap mimeograph paper. We then purchased a typewriter for \$6.00 down and \$6.00 a month (they're available if you keep plugging) and a used mimeograph machine for \$12.50, and put out 350 direct-mail letters every two weeks to a mailing list compiled from the roster of the local Chamber of Commerce and other civic organizations. These letters are varied and intended to appeal to all the different tastes of the various recipients. The few examples shown here give a good idea of how a little rough "art" can liven up an otherwise dull circular.

Here's the payoff: We did a gross service business of \$739 our first month (we were strangers in town, too). For a one-man unestablished shop, that's not chicken feed! Advertising alone is not the whole story (and we did advertise, in the local pa-

per as well as by direct mail). The customer must be impressed by your layout and your business methods if he is to bring you his radio for repair, and he must feel that he got a good job and a good deal if he is to say a good word for you among his friends and acquaintances. This is how we do it:

When we repair a radio set, we not only replace the definitely defective part or parts, but also any that show any electrical or physical deviation from normal. True, this results in a higher repair bill, but we make a 90-day unconditional guarantee that more than offsets the impression the customer may get from the slightly higher bill. Any radios that are returned under the guarantee are given priority over new jobs. To facilitate their speedy handling, we use a red job card to indicate they are to be worked on first. Reason for the return, time, and parts used are listed on the card. The parts are charged out of stock each week on a book used for that purpose. The cost of maintaining our guarantee has been less than one-half of one percent of our gross revenue so far.

My wife, who serves as receptionist and bookkeeper, also has charge of all routine operations in the shop. She can converse intelligently with customers about their radios, and she enters their descriptions of faulty operation of the receivers on the job card for serviceman's reference. She dispatches all work orders and gives the customer an approximate date when he can call for his radio.

The customer's receipted bill is his guarantee. The charges are itemized under several heads (printed along the left-hand side of the bill): Parts, Tubes, Merchandise, Miscellaneous and Labor.

Besides the bill given the customer, a sticker is pasted into his set. A serial number on the sticker refers to the job sheet for the set. If a set once repaired comes back to this shop, its past history can be turned up instantaneously. This is a great convenience to the serviceman, but would pay for itself by its effect on the customer alone. His confidence is greatly increased by seeing that you know all about his set, and possibly also by the fact that he sees you have a systematic way of doing business.

Customer confidence is further built up by the attractive appearance of our shop. It has the advantage of being specially designed for its purpose, and even from the outside looks like a radio shop pure and simple. Inside it is divided into a front office and reception room, and workshop. The tube tester (Model 589 Supreme counter type) is kept in the front office. A large glass window between office and workshop solves the old problem of doing the work out in the open or in a special "laboratory." The serviceman can work without having customers breathing down the back of his neck, and the strange and sometimes suspicious customer does not feel that his set is being taken away from him and hidden in a back room.

Our bookkeeping system is so set up that at the end of each day the last column of our ledger shows the exact

(Continued on page 64)

A typical bill for radio service and parts

Texoma Radio Company
"Denton's Complete Service Station"

1218 W. CHESTNUT PHONE 246 DENTON, TEXAS
JOB NO. 255 DATE 5 12 1946
M D Day
Address 527 Blank St
PARTS

QTY	DESCRIPTION	PRICE	AMOUNT
1	10WAT 500 Ohm Res		45
1	20/150 Filter		80
			110
Tubes	1 43		
			10
MISC.	1 #46 Dial Lamp		
SP. PARTS			
LABOR	Chas. Allen and replace parts		4
TOTAL			164

PAID
MAY 13 1946
CASH



NEW RADAR FOR AIR SAFETY

FLYING safety has taken on new importance with the sharp upswing in air transportation services, and has been drawn sharply to the public attention by the series of misadventures which featured the bad-weather period of this winter. A greatly increased number of planes is available, and more people than ever require the speedy service of air travel. But they want safety.

The Army and Navy have had an excellent record for safety in all-weather flying. Depending on Ground-Controlled Approach (GCA) for the fixed installations, they have worked continually toward the aim of safety at any time, anywhere, whether far from an airfield with its GCA or not. To that end, the Army has let a contract for a small simplified radar which will weigh about 100 pounds and be compact enough for use in the average

medium-weight commercial or military transport plane.

The new radar would be a further improvement over military lightweight radar built for the Army Air Forces during the last few months of the war. This wartime radar, the APS-10 (illustrated on our cover) weighed about 150 pounds with auxiliary power supply and was operated by 5 controls.

These sets contrast sharply with 500-pound, 34-control radar employed by the Army Air Forces throughout most of the conflict.

Power of the new radar will be increased 8 times over the APS-10 version, and maintenance provisions will be simplified, it is claimed. Present maximum range of the APS-10 is about 90 miles. An extension in range is expected with the new version.

Commercial airlines, the Army Air Forces, CAA, and the General Electric Co., manufacturers of the equipment, are currently experimenting with the APS-10 radar to work out adaptations for early application for many types of air transport agencies.

Features of the Instrument

Although the APS-10 military aircraft radar was designed primarily for wartime missions and does not meet all requirements of commercial peacetime airline operators, it does perform a

Below—AN/APS-10 installed in an AAF C-47. At left—Antenna mounted beneath fuselage. Official photos, Aircraft Radio Lab., Wright Field.

number of useful peacetime tasks which can be of immediate advantage.

The APS-10 is a plan-position indicator type of radar, adapted also to receive signals from beacons which appear as coded marks on the 'scope. Thus it is possible to obtain bearings from positively identified points or, when feasible, to "home" on the beacons as on an aviation beam.

The PPI feature does not give images of equal clarity to those of larger instruments. If two targets are close together, they blend into each other. Thus it may be impossible to identify landscape features with absolute certainty. Two islands, if close together, may appear as one. A group of islands, however, would be clearly seen as separate from the water surrounding them, and a large group of buildings would be easily identified.

Over New York, for example, the APS-10 radar tells the pilot he is above the city, points out the different rivers, the George Washington Bridge, and the general location of the skyscraper area. It will not see individual buildings. It does tell the pilot where he is in relation to the ground objects he can identify. With such information he can avoid such structures as the Empire State building.

Range rings are traced on the screen to indicate various distances, from four miles to fifty. Angular lines traced on a transparent plastic overlay also divide the screen into 10-degree segments. These may be seen in the cover picture. (The "V" of light is a test signal used in checking operation of the device.)

The lightweight radar can be used to indicate drift angle, to check wind velocity and direction, to compute ground speed, and to check the plane's actual altitude (terrain clearance). These uses make it a useful auxiliary to and check on other instruments carried by the plane.

A Storm Detector

This airborne radar also can locate severe storm areas over land and sea, even though it cannot see into intense storms. Pilots can either avoid such areas or fly through storm "soft spots" as indicated on the radar screen. This is regarded by electronics engineers as one function which can contribute immediately to safe flying and increase passenger comfort.

In mountainous terrain, the wartime radar can be adapted to indicate the direction and distance of mountain peaks which constitute a collision hazard. Its ability to give altitude of

(Continued on page 40)

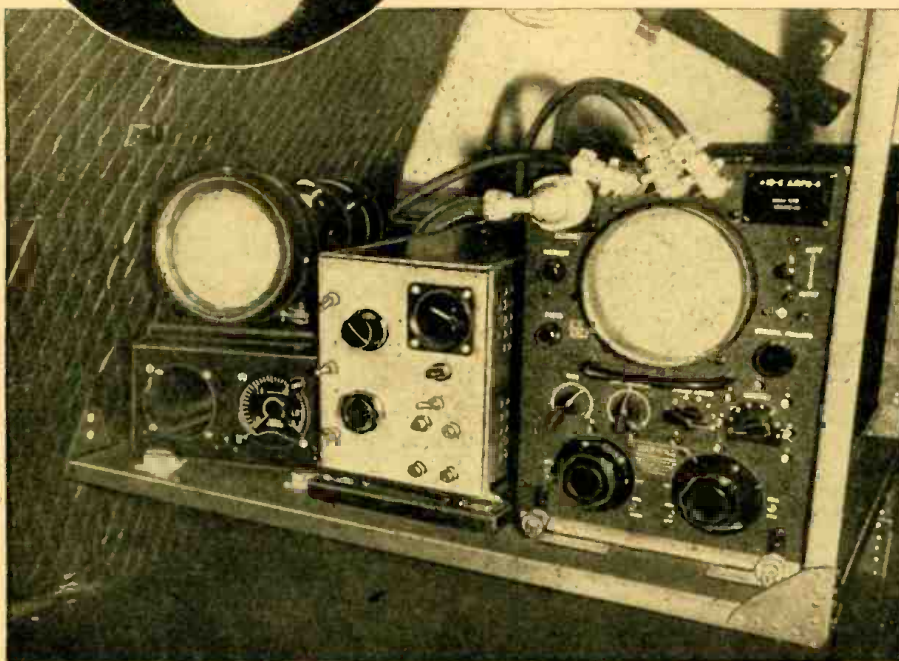
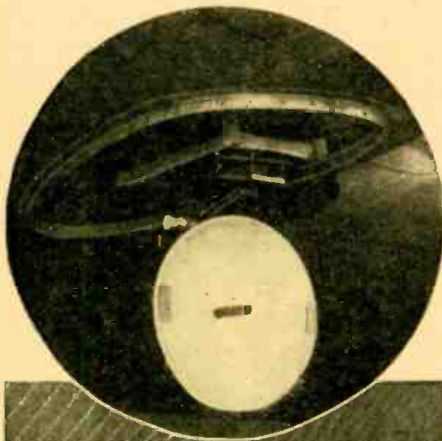

SWITCHING AND TRIGGERING

Two Fundamental Electronic Control Circuits

ELECTRONIC control plays an increasingly important role in our everyday life.

Modern industry requires infallible, microsecond precision and completely automatic control of many manufacturing processes. Highspeed inspecting, counting, sorting, measuring, and safety-device equipment all make for fast and economical production.

Electronic control also performs similar but simpler functions in the household or radio shack—closing windows at certain temperatures, operating radio gear remotely, switching on lights at prearranged times, burglar-proofing houses, counting objects, or measuring—with four- and five-place decimal accuracy, if necessary.

The design of almost all electronic control equipment is based upon a few simple circuits, and therefore the principles of electronic control devices are not difficult to understand.

Foremost among the uses of this type of control are circuits used for *switching, triggering, counting, sorting, and measuring*. These are the functions with which this and a subsequent article are concerned.

Although the terms *switching* and *triggering* are somewhat similar in use and popular meaning, there is a distinction between them.

An *electronic switch* is a control circuit providing carefully defined electronic impulses. These pulses are in most cases converted into mechanical or electro-mechanical energy which causes some physical action or change to take place in another circuit or device. An important characteristic of switching circuits is that they provide both a start and a stop action (Fig. 1) by means of the control wave form. While their action is comparable to a mechanical on-off switch, electronic switches are capable of extremely high speeds of operation.

An *electronic trigger* is a control circuit whose output is used only to start an action in another circuit or device (Fig. 1), the resultant action continuing for a time under its own control and then stopping of its own accord.

Fig. 1-a shows the control impulse applied to both trigger and switching circuits. (Most triggering pulses are in fact much shorter than the square waves shown.) The resultant trigger action is shown in Fig. 1-b, and the resultant switching action in 1-c.

Counting, sorting, and measuring circuits provide impulses of certain shape and amplitude for coupling to visual or aural indicating systems.

Counting circuits provide output impulses in proportion to the *frequency* of input impulses which represent the phenomenon being counted. Sorting circuits provide output impulses in proportion to the comparative amplitudes of input impulses. Measuring circuits provide output impulses proportional in amplitude to some dimension of the object under observation. Other types of measuring circuits use cathode-ray tubes to provide visual measurements *in terms of time*. These and other counting and measuring circuits will be discussed in greater detail in a forthcoming issue of RADIO-CRAFT.

Electronic Switches

The principal purpose of switching circuits is to provide a source of sharply defined control impulses (Fig. 1) which can be used to open, close, reverse, or otherwise influence the operation of related circuits or devices connected to the output of the electronic switch.

Such action may be brought about by either mechanical or electronic means, depending largely upon the required

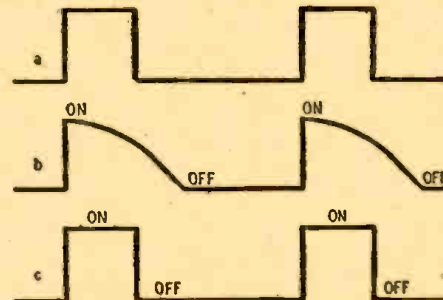

Fig. 1. a—Control pulses; b—resultant triggering action; c—resultant switching action.

speed of action but also upon the nature of the connected apparatus. For slow rates of speed—up to about 100 repetitions per minute—switching is accomplished by conventional, directly energized relays.

But for higher rates of speed—the more usual instances—electronic switching circuits are used. These consist of one or more gas-filled or high-vacuum tubes, supplying a series of control pulses. The output pulses may govern the operation of other, purely electronic circuits, or may actuate low-capacitive noninductive relays or other electro-mechanical devices.

An electronic switch can be arranged to generate and shape the control impulses entirely without external synchronization or control. This type of switch is used in precision regulation,

where output pulses must occur according to some fixed period of time. Once adjusted, the switch functions under its own control.

However, when a control source is available or is necessary, an electronic switch is used as an amplifying, pulse-shaping, or merely an isolating circuit—connected between the control source and the relay or device to be actuated. This is the more general use of the electronic switch. But in either case—with or without external control—action of individual stages of the circuit is almost identical.

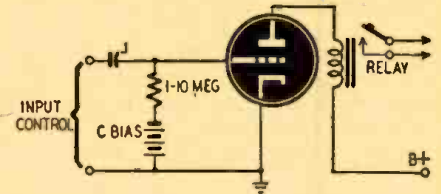

Fig. 2—A simple type of electronic relay.

The simplest type of electronic relay (Fig. 2) uses a single triode and a current-operated relay. This circuit requires external control positive voltage applied between grid and cathode—but the tube draws negligible current from the control source. The triode operates with a fixed negative bias to prevent conduction, and no current flows in the plate circuit of the tube. However, when voltage from the control source becomes sufficiently positive, the tube conducts and the relay is energized. Action of the relay is determined by the voltage from the control source, and output frequency by the input frequency of positive-going impulses above the critical operating value for the tube.

Usually the external control source is of very low power and incapable of actuating relays or other devices. The use of one or more tubes provides the necessary amplification. The principal advantage of the device is that it operates without drawing appreciable current from the control source.

Relay Control

One practical application of the basic electronic relay is a temperature control circuit (Fig. 3) using a phototube as the control source.

Many manufacturing processes are dependent upon a constant temperature during production or formation. Since temperature can be controlled electronically (by circuits similar to Fig. 3) with greater accuracy and less expense, large numbers of workers to watch

(Continued on page 70)

THE POSTWAR RADIOS

**FIRST
COMMERCIAL
POCKET RADIO**

The Belmont Boulevard



The Boulevard is little longer than a fountain pen.

FIRST of all the promised postwar vest-pocket radios is the Belmont Boulevard. It is a 5-tube superheterodyne only 6 inches high, 3 inches wide and $\frac{3}{4}$ inch thick. With its earphone-cord antenna only $2\frac{1}{2}$ feet long, it brings in all local stations with good volume, and when near metal carriers of r.f. current (telephones, electric wiring, antennas) picks up weaker stations. Selectivity, because of r.f. stage, is better than that of the average 5-tube small radio. The set—by actual experiment—*does* fit comfortably into a vest pocket.

Subminiature tubes of the type originally developed for the proximity fuze make such remarkable compactness possible. They include a triode-heptode (2G22) which has *nine* active surfaces between two glass walls only a quarter inch apart. The other tubes are two 2E32's as r.f. and i.f. amplifiers, a 2E42, which acts as diode detector and first audio frequency amplifier, and the 2E36 pentode in the output stage. The power output of this tube is 6 milliwatts. Small as this may sound, it means more than comfortable volume in the crystal earpiece on strong local stations. Fairly loud signals may be

received without noticeable distortion. Characteristics of these tubes are given in Table I.

Variable-iron-core tuning is used in the sub-tiny receiver. The permeability-tuning units are to be seen at the top in the chassis photo. The half-extended iron cores are to the right of the cans. Smallest of all practical tuning devices, they are the i.f. coils (only slightly smaller than below). The rectangular construction of the Raytheon subminiature tube is suited excellently to close spacing. The i.f. cans between which they are placed contribute to the shielding, which is completed by the aluminum case.

The set is operated in the conventional manner, with the volume control and switch connected to one knob and the tuner controlled by a second. A feature immediately noted by the wearer of one of these sets is the extreme variability of r.f. fields in certain locations. In certain office buildings, a station may be received well at one point and entirely inaudible at another only two or three feet away.

Reception on the street is also spotty, and is better at open intersections than on sidewalks in front of certain buildings. Other structures seem to act as antennas, and reception was surprisingly better in a cage-type elevator than at other points in the same building.

The small filament batteries are said to operate "about three hours." Actually, a set of new batteries gave 3 hours 20 minutes *continuous* service, and no doubt would have lasted longer had the

radio been playing intermittently. The B-battery is supposed to run for 40 to 50 hours. Cost of operating the set would therefore run a little under five cents an hour.

A very complete folder is supplied to the customer with the set. He is instructed in its use, told what he may and may not expect from it, and given careful direction for battery removal and replacement. The very full instructions should serve as excellent insurance against disappointment in or damage to the receiver.

Servicing these little radios will present a number of new problems to the radioman. His first reaction on looking at one of them will be one of relief. Most of the parts are at least as easy to get at as those in many 3-way portables or even midget table receivers. It is their size which is disconcerting. Once the serviceman has adjusted himself to these minute components, standard test procedure may be modified to take them into account. The extreme probability that the set may not work normally when out of its case must be taken into account, and the serviceman's equipment will probably include a jig for keeping the batteries in place and side-plates to act as shields and stabilize operation.

Stripping down to the chassis is remarkably easy. The end bell over the batteries is taken off by removing the holding screw and lifting off the bell, screw end first. It is held in place by four long bosses which fit into similarly-shaped recesses in the bell. The case, which is similarly held to the top end bell, is then sprung loose in the same manner. The top end bell can be left in place for most repair jobs, but if necessary it can be removed by taking off the two knobs and taking out the two small screws which will be found under the tuning knob.

In view of the special equipment (small soldering irons and tools) needed, many repairs on this radio may possibly be handled more profitably on a manufacturer's service basis, shipping the set back to the factory to be repaired with the help of special equipment. Belmont recognizes the role of the legitimate serviceman, however, and instructs the customer to "take it (the radio) to a competent serviceman if it does not operate properly." Complete alignment instructions (Table II) are printed in the folder, which the customer is instructed to take to the serviceman with him. Few companies in the

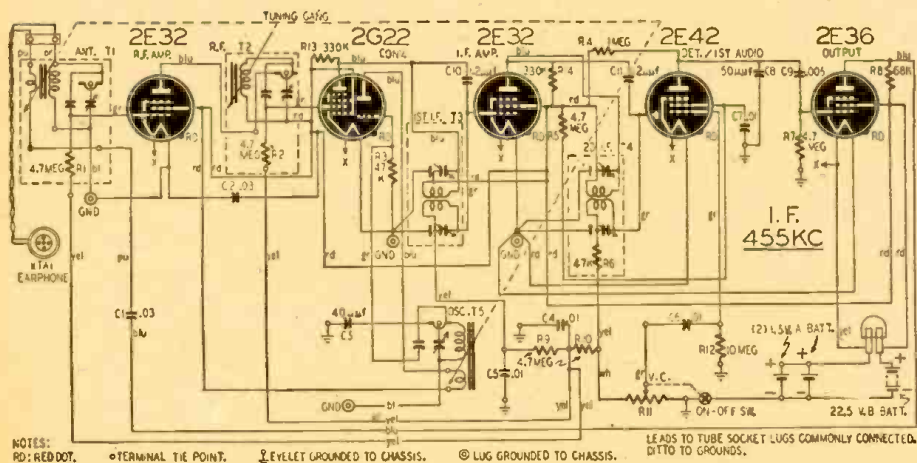

Schematic diagram of the Belmont Boulevard. Circuit is similar to that of standard sets.

TABLE I

2G22

RATINGS

Filament Voltage	1.25	volts
Filament Current	50	ma
Maximum Heptode Plate Voltage	45	volts
Maximum Heptode Screen (Grids Nos. 2 and 4) Voltage	45	volts
Maximum Triode Plate Voltage	45	volts
Maximum Total Cathode Current	2.0	ma
Minimum External Signal Grid Bias	0	volts

TYPICAL CONVERTER OPERATION

Plate Voltage (Heptode)	22.5	volts
Screen Voltage (Heptode Grids #2 and #4)	22.5	volts
Oscillator Plate Voltage (Triode)	22.5	volts
Signal Grid Bias (Heptode Grid #3)*	0	volts
Oscillator Grid Resistor (Triode)	50000	ohms
Plate Current (Heptode)	200	µa
Screen Current (Heptode)	300	µa
Oscillator Plate Current (Triode)	1	ma
Oscillator Grid Current (Triode)	30	µa
Conversion Transconductance	60	µmhos
Conversion Transconductance at Signal Grid Bias = -3.5	2	µmhos
Conversion Plate Resistance (Approx.)	0.5	meg.

2E32

RATINGS

Filament Voltage	1.25	volts
Filament Current	50	ma
Maximum Plate Voltage	45	volts
Maximum Screen Voltage	45	volts
Maximum Cathode Current	1.0	ma

TYPICAL CLASS A₁ OPERATION

Plate Voltage	22.5	volts
Screen Voltage	22.5	volts
Control Grid Voltage*	0	volts
Plate Current	0.40	ma
Screen Current	0.3	ma
Transconductance	500	µmhos
Plate Resistance	0.35	meg.
Grid Bias for Plate Current = 10 µa	-2.0	volts

2E42

RATINGS

Filament Voltage	1.25	volts
Filament Current	30	ma
Maximum Plate Voltage	45	volts
Maximum Screen Voltage	45	volts
Maximum Cathode Current	1.0	ma

TYPICAL R-C AMPLIFIER OPERATION

Plate Supply Voltage	22.5	volts
Screen Supply Voltage	22.5	volts
Load Resistance	1	meg.
Screen Resistance	5	meg.
Voltage Gain	20	

TYPICAL DIODE RATINGS

Minimum Diode Current with 10 Volts D.C. Applied	0.5	ma
Maximum Diode Current for Continuous Operation	0.25	ma

The diode plate is located at the negative end of the filament.

2E36

RATINGS

Filament Voltage	1.25	volts
Filament Current	30	ma
Maximum Plate Voltage	45	volts
Maximum Screen Voltage	45	volts
Maximum Cathode Current	1.0	ma

TYPICAL CLASS A₁ AMPLIFIER OPERATION

Plate Voltage	22.5	45	volts
Screen Voltage	22.5	45	volts
Control Grid Voltage	0*	-1.25	volts
Plate Current	0.27	0.45	ma
Screen Current	0.07	0.11	ma
Transconductance	385	500	µmhos
Plate Resistance	0.22	0.25	megohm
Load Resistance	0.15	0.10	megohm
Distortion	10	10	per cent
Power Output	1.2	6	mw

* Grid resistance = 5 megohms.

past have been more considerate of the repairman.

This and similar radios have an assured future as super-portables which can be carried (and packed) where a full-sized portable would be impractical. Certain types of night workers (notably nurses and night watchmen) whose work includes much lonely vigil but who for various reasons cannot avail themselves of a larger portable radio, will be a very steady market for this type of set. Music lovers may find it more suitable than the loud-speaker type of portable for outdoors use, as the latter must usually be turned up well beyond the point of tolerable distortion to be heard in the open air.

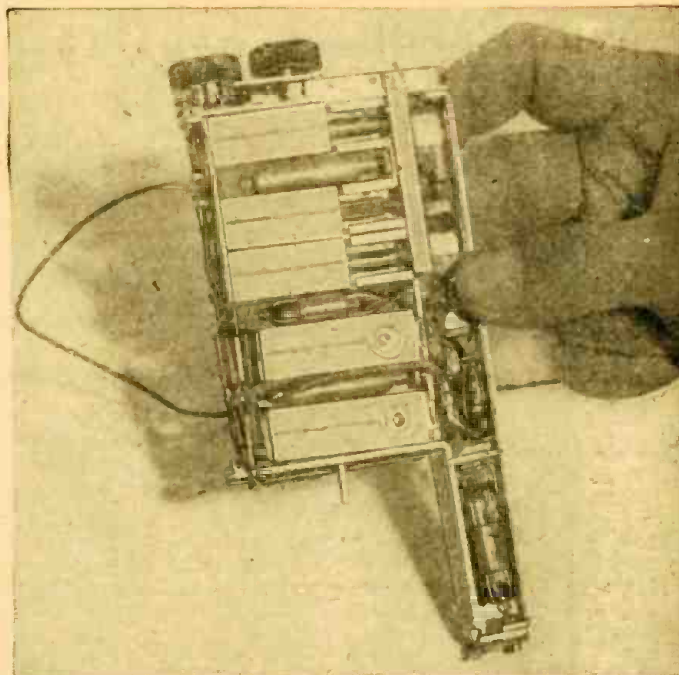

Chassis view. Layout is neat and rational in spite of small size.

Looked forward to as a novelty, the vest-pocket radio may find itself a more practical receiver than the "standard" battery-powered portable.

TABLE II—ALIGNMENT PROCEDURE

- Output meter must give 1.5-volt deflection without loading output tube.
- Use any 1½-volt "A" battery and 22½-volt "B" battery which can be connected to set. Keep battery leads short.
- Unsolder lead between .03 mf output capacitor and purple lead. Connect one side of meter to this capacitor terminal, other side to receiver chassis. Be sure to reconnect leads after alignment is completed.
- Volume control at maximum.
- Connect ground lead of generator to chassis.
- Align for maximum output. Reduce input as needed to keep output near 1.5 volts.

Generator Frequency	Coupling Capacitor	Connection to Set	Adjust for Max. Output
455 kc	.1 mf	Converter 2G22 grid	Trimmers on both I.F. transformers
1625 kc	.1 mf	Converter 2G22 grid	Oscillator trimmer
1400 kc	.1 mf	Converter 2G22 grid	Oscillator tuning slug*
1625 kc	10 mmf	Antenna lead	Osc. ant. rf trimmers
1400 kc	10 mmf	Antenna lead	Antenna, rf tuning slugs*

*Repeat this, and previous step alternately for best tracking.

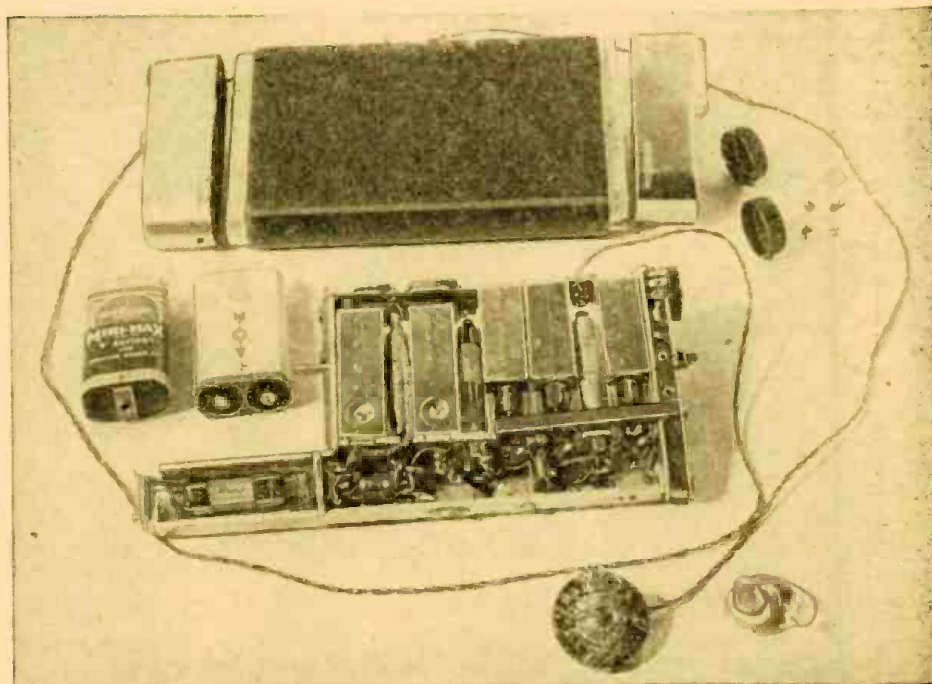

Exploded view. All parts of the Belmont Boulevard are shown in this photograph of the radio.

DUTCH UNDERGROUND RADIOS

By J. MAQUERINCK

WHEN the Nazis, who had occupied Holland since 1940, forbade all radio listening and confiscated all receivers in the spring of 1942, radio listening was driven underground. Only by listening to the BBC and Radio Boston could we know how the war was going.

It is my purpose to tell you something about the sets we built and how we concealed them.

Let me begin with the receiver built by a friend of mine. Luckily he was the owner of a crystal, and so he built the



Mr. Maquerinck was unable to take photos of his radios. These underground sets were described in an article in the Philips Technisch Tijdschrift.

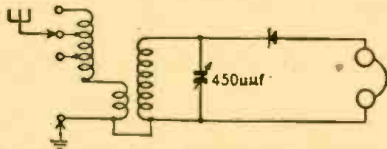

Fig. 1—This set received English stations.

set the schematic of which is given by Fig. 1. The entire assembly was placed in a cigar box, complete with headset and tuning condenser. When he wanted to listen, he opened the box, connected ground and antenna, put the headphones on his head and tuned the circuit. This set was very selective and the only disadvantage was its weak reception.

My neighbor, in a set the diagram of which is given in Fig. 2, used an old battery tube.

The plate voltage was taken from the A-battery and the results were much better than those obtained with a crystal detector.

The coil was tuned with an iron-powder core only and no condenser was used. Tuning was not very sharp, but this wasn't needed in the beginning, because the German interference transmitters did not come until later on.

In the beginning I used the set shown in Fig. 3.



Fig. 2—One-tube radios were more sensitive.

It had a high- μ beam-power pentode, connected as feedback detector. It gave good speaker output and was sensitive enough to play on a 30-foot antenna.

It was tuned by an iron-core coil and a fixed condenser with a trimmer for just alignment. So it was fixed on 200 kc, the BBC wavelength. Tube was an EL6.

This set worked very well, but it couldn't be hidden. Besides, it needed an antenna, and an outside antenna would be seen.

I decided to build a set that didn't need an external antenna. The result you see in Fig. 4. It uses a triode-heptode tube which has three functions: r.f. amplifier, grid-leak detector, audio amplifier.

The plate supply, being 43 volts, is obtained from the A-battery. The tube, a U.C.H. 21, operates with this heater voltage.

The coils are of the iron-core type, wound on a low-loss form with core in center. The set is tuned with a fixed condenser of 500 μ mf and a 3-30- μ mf trimmer across it. The coils are shielded by pieces of copper sheet, bent in the right form.

Needless to say the tuned wavelength was 200 kc.

Tube, coils, resistors and condenser, r.f. choke and A-battery—the entire equipment was put into a phone cabinet, after I had removed the phone parts. Fig. 5 shows how it looked.

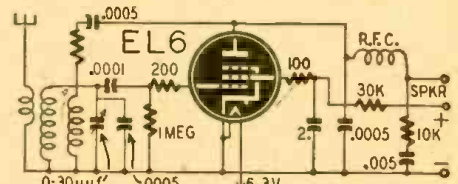

Fig. 3—One of the author's early circuits.

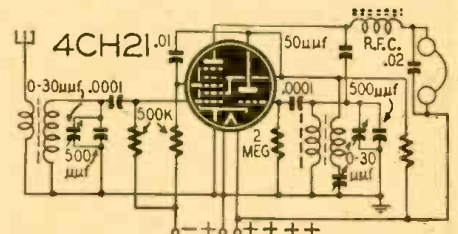
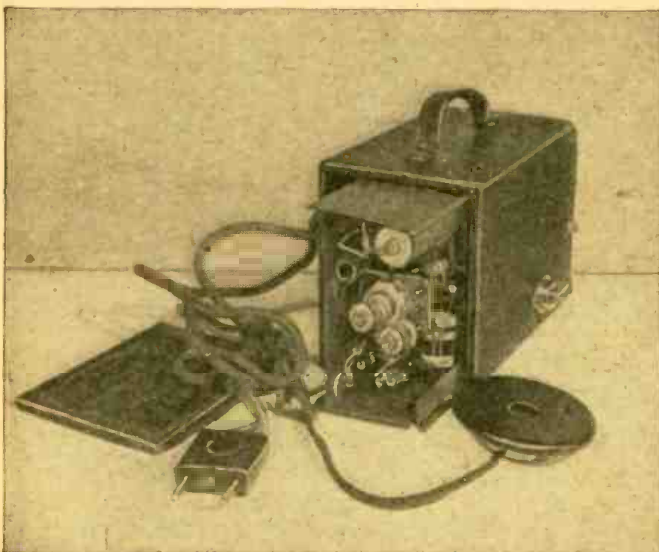

Fig. 4—This set operated on a body antenna.

This was a very satisfactory way of concealing the set and I didn't need a cabinet. That the phone was dead wasn't much loss, because it had been defective for months.

An antenna wasn't needed, because my finger was antenna enough. Maybe I have a very high body capacity, but I

(Continued on page 62)



Courtesy Eastman Kodak Co.

"Brownie" receiver built by Mr. F. M. Leopold of Eindhoven, Holland.

EQUIPPING THE SHOP

Multitester, tube checker and signal generator are necessary equipment in every service shop. →

"WHAT test equipment should I buy" is one of the questions most commonly asked by the returning service man. Many of these men have had plenty of experience with radio repairing in the army, but civilian radio repairing is new to them, and they find it difficult to orient themselves to civilian radio service procedure. Many of these men find radio repair highly interesting, and believe they could make it reasonably profitable. They lack commercial radio servicing experience, and would like a little forehanded information to substitute for the costly and often disastrous process of "picking it up as you go along."

A complete answer to the question would involve writing a book. Three essential pieces of test apparatus are necessary: a good volt-ohmmeter, signal generator and tube tester. The apparatus selected should be made by a well-known firm of good reputation. Cheap equipment is no better in radio than in a suit.

The volt-ohmmeter should be capable of measuring resistances as high as 10 or 20 megohms and voltages, a.c. and d.c., as high as 1000. Special apparatus may be necessary for television sets, but the average service job can be handled efficiently using the above apparatus. The signal generator should be well shielded and equipped

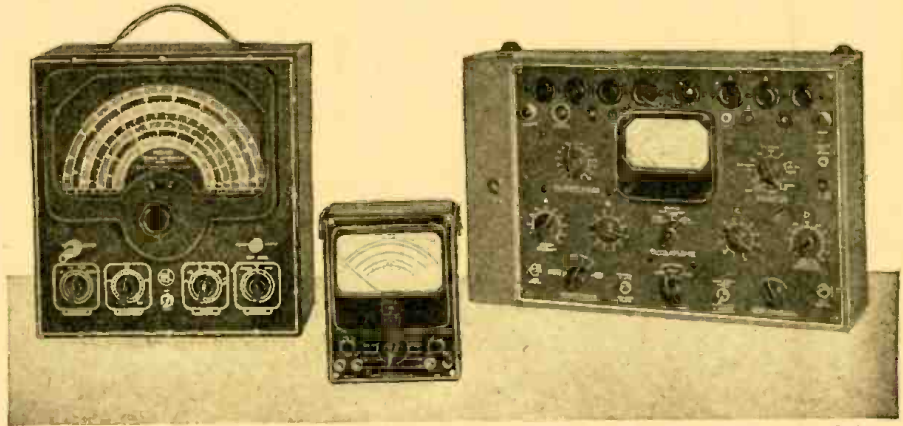

Photo courtesy Milo Radio and Premier Electronic Labs.

with a clear, accurately calibrated dial. It should be capable of covering a range from 100 kc to as high as 20 or 30 mc. Later, a special high frequency generator for television and frequency modulation work may be added, since high frequencies are used for FM and television in the new bands.

The tube tester should be accurately calibrated. It is particularly important that the purchaser obtain with the instrument at the time of purchase full calibration data and instructions. The tester should be capable of testing all of the latest types of tubes used in receivers, especially those having high voltage heaters, such as the 117L7. Building a tube tester is utterly impractical. You would have no means of calibrating the instrument; a manufacturer may run tests on hundreds of tubes in develop-

ing a suitable tube tester, then construct an accurate master model. Other testers sold on the market, then, are merely copies of the master model into which a great deal of research has gone. It is sheer folly to build your own instrument if accuracy is desired.

Later, a signal tracer, frequency-modulated generator, cathode-ray oscilloscope and capacity bridge may be added to the test bench. Many expert servicemen have no need for a signal tracer and scoff at the idea of using one—because they know fundamental radio principles very well and are able to use them in testing.

Next most important question is: "What radio parts should I stock?"

Go slowly at first—buy only what you need. After doing a few jobs you will know what to order to meet your own requirements. In general, a number of small 16- μ f or 20- μ f 150-volt electrolytics of the single negative, two positive type will be useful. These may be midget varieties because they will fit easily into compact sets. It is important to distinguish between common negative and common positive condensers. A number of small 8- μ f and 16- μ f condensers rated at 450 volts may be used to replace filters in a.c. sets having full-wave rectifier power transformers. The 150-volt electrolytics are used in a.c.-d.c. sets. Refer to the diagram of the receiver you are servicing and to the manufacturer's data. A number of 400-volt paper condensers rated at 400 volts are useful. Obtain several in the following sizes: .01 μ f, .05, .006, .1, 25 μ f. These will meet practically all requirements. Buffer condensers in auto sets often fail and are high voltage types rated at 1200 or 1500 volts. The higher voltage rating is desirable to minimize breakdowns.

Another question frequently asked is, "Where may I obtain radio circuit diagrams?"

The answer might be "almost anywhere," but we can be more specific. Diagrams may be obtained through radio distributors and mail order houses; they appear in radio servicing magazines available on newsstands in some cases; they may be obtained by writing directly to the manufacturers, some manufacturers have bound service

(Continued on page 66)



The well-fitted and efficient service shop of Mr. C. L. Reynolds, Binghamton, N. Y.

THE 'SCOPE—A REPAIR TOOL

Part II—Checks on the R.F. Portions of the Receiver

IN THE first part of this article published in the January (de Forest Anniversary) issue, an orderly test procedure was set up and a chart developed to show the use of the oscilloscope for maintenance and repair tests, starting from the power supply section and working backward through the speaker and the a.f. section of the receiver under test.

The procedure described used a signal generator to inject the appropriate signal and *quick check points* for the 'scope connections, as a method for moving rapidly through those sections that were shown to be O.K. by their satisfactory response to the injected signal—until a point was reached where the section showed evidence of trouble. That particular section of the circuit would then be covered in detail by the steps shown in the chart. This method requires a total of five quick check points, one each for the d.c., a.f., i.f., oscillator, and r.f. sections of the receiver. The first two of these sections, (d.c. and a.f.), were considered in the first part of the article. We now continue with the quick check points for the other three sections, the i.f., oscillator, and r.f. sections. The tests are assumed to be carried out on a typical 5-tube receiver, the schematic of which was printed in the first part of this article. This was an a.c.-d.c. receiver, with the "All-American" 12SA7, 12SK7, 12SQ7, 50L6, and 35Z5 tube lineup.

Two optional procedures are shown for obtaining further information if desired. One additional step tests the i.f. bandwidth response. The remaining step tests the over-all frequency response of the entire receiver.

The chart gives a condensed guide to the procedure for each step and the proper interpretation of the resulting indication. The appearance of the expected pattern is shown and numbered to correspond with each numbered step. Some additional patterns, such as would be produced by common troubles in the receiver, are also illustrated.

Requirements for R.F. Tests

Before proceeding with the tests for the i.f. section, it is well to consider the qualities needed in the 'scope to enable it to interpret faithfully signals in the radio-frequency range, which, of course, includes the i.f., oscillator and r.f. sections.

The qualities necessary for satisfactory oscilloscope performance will depend mostly on the type of indication that the 'scope is called upon to give for any particular test desired. Thus, if the experimenter wants to observe the r.f. wave coming into the set at the antenna terminals, so wide a response is needed from 'scope amplifier as to be entirely out of line with what can be expected from an ordinary 'scope. Even though more costly laboratory equip-

ment is available to handle such a requirement, the cost would run into much more than a hundred dollars over the cost of an ordinary instrument. It would therefore be foolish for the serviceman to invest in such a high-priced and specialized piece of equipment for the essential applications which he needs for set servicing, even though the specialized 'scopes do have a well-established value in certain other applications.

The main question is: "What important observations do I need from my 'scope?" Since the home radio receiver is designed to receive a modulated radio-frequency wave from the broadcast transmitter and convert this so that the set can reproduce the audio portion of this wave, the serviceman finds himself in the fortunate position of needing only such a response from the 'scope as will amply cover the audio frequencies. This response, for a perfectly working set, would include the harmonics present in high-fidelity reception and so run up to about 20,000 cycles. To observe the many possibilities of a distorted audio wave, the 'scope response should reach preferably to about 50,000 cycles (with at least 50-percent response at 100 kc), combined with a corresponding associated sweep range of around 25,000 cycles. The above requirements are met satisfactorily by most of the oscilloscopes on the market, (Continued on page 56)

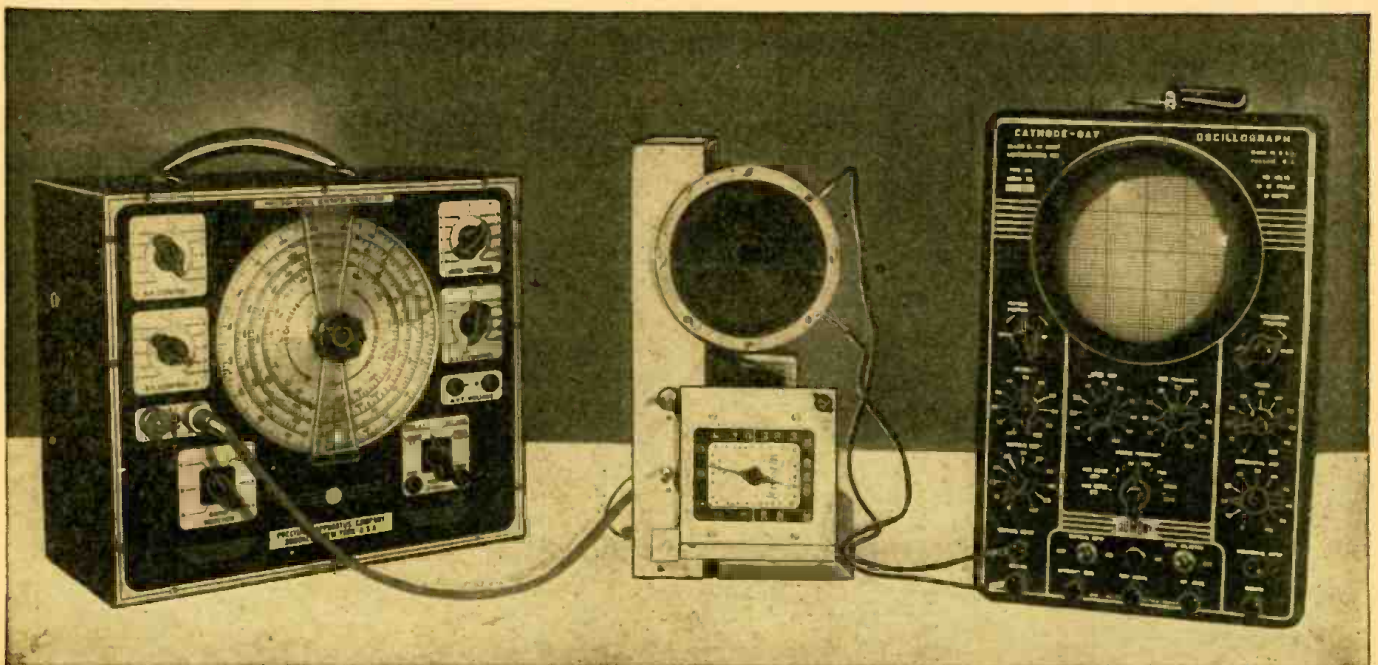

A signal generator (with self-contained audio oscillator) receiver and oscilloscope set up to run the tests described in this article.

TABLE OF TEST CONNECTIONS

PATTERN 18a



PATTERN 10

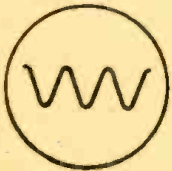

PATTERN 11

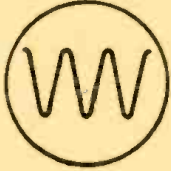

PATTERN 12

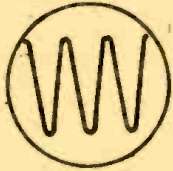

PATTERNS 13, 14



PATTERNS 15, 16

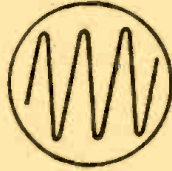

PATTERN 17



PATTERN 18b

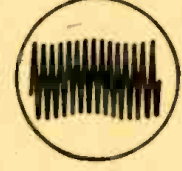

INDICATION DESIRED	'SCOPE CONNECTIONS TO SET	'SCOPE ADJUSTMENT	PATTERN TO BE OBTAINED	INTERPRETATION
I.F. Section Test No. 10 Second i.f. transformer	I.f. signal 455 kc, modulated at 400 cycles through blocking condenser (0.05), to plate of 12SK7 (pin 8) and chassis. 'Scope to high end of volume control.	Adjust i.f. signal to lowest value that will give useful reading of audio modulation signal (400 cycles) on 'scope.	(Pattern 10) Demodulated i.f. signal through 2nd i.f. transformer.	Second i.f. transformer and diode portion of 12SQ7 operation.
Test No. 11 I.f. amplifier tube 12SK7	Shift generator signal to grid of 12SK7 (pin No. 4)	No change, except to decrease strength of generator signal if necessary.	(Pattern 11) Demodulated i.f. signal (400 cycles) after amplification by 12SK7.	12SK7 i.f. amplifier tube amplification.
Test No. 12 First i.f. transformer	Shift generator signal to plate of 12SA7 (pin 3).	No change. Align i.f. trimmers of 1st i.f. transformer for maximum peak.	(Pattern 12) Demodulated i.f. signal (400 cycles) through 1st i.f. transformer.	1st i.f. transformer operation and alignment.
Test No. 13 Converter tube 12SA7 amplification on a.v.c. operation.	Shift generator signal to grid of 12SA7 (stator of ant. tuning condenser).	Attenuate i.f. signal according to amplification of output. Then increase value of i.f. signal to obtain temporarily greater a.v.c. action.	(Pattern 13) Demodulated i.f. signal (400 cycles) through converter tube 12SA7.	Amplification of 12SA7 and a.v.c. action.
Quick Check Point Test No. 14 Over-all i.f. section from grid of converter to diode load resistance.	I.f. signal (455kc) modulated at 400 cycles, through 0.05 condenser to stator side of ant. tuning condenser; 'scope across high end of diode load resistor and chassis.	Attenuate i.f. signal to give useful reading on 'scope. Adjust i.f. trimmers for maximum output.	(Pattern 14) Demodulated i.f. signal (400 cycles) through i.f. system.	Over-all operation of extra i.f. portion.
Quick Check Point Test No. 15 Receiver oscillator section.	Same as test No. 14. Change freq. of r.f. signal to 1425 kc (mod. at 400 cycles). 'Scope across voice coil.	Attenuate r.f. signal to give useful reading on 'scope with set operating at max. volume. Adjust oscillator condenser trimmer for maximum output.	(Pattern 15) Receiver output while adjusting osc. trimmer.	Receiver oscillator functioning.
Quick Check Point Test No. 16 R.f. section and over-all receiver performance.	(a) Form loop for r.f. signal from generator (1425 kc mod. at 400 cycles). Couple this loop to receiver loop; 'scope remains across voice coil. (b) Change r.f. signal frequency from generator to 600 kc and repeat.	(a) Vary coupling and attenuation of r.f. signal to give useful reading on 'scope. Adjust antenna condenser trimmer for max. output. (b) Retrim ant. and oscillator trimmers of tuning condenser.	(Pattern 16) Receiver output while adjusting ant. tuning condenser.	R.f. alignment and over-all receiver performance.
Additional Optional Tests (for high-fidelity testing) Test No. 17 I.f. Band-width response curves.	Frequency-swept ("wobulated") signal from generator (center frequency 455 kc) connected as in steps of Nos. 10 and 12, with sweep-rate sync signal connected to EXTERNAL SYNC. of 'scope. Scope connections at voice coil.	Adjust sweep rate for stationary forward and reverse pattern; adjust i.f. trimmers for best balanced i.f. response.	(Pattern 17) Off resonance response curve.	I.f. alignment and side-band response.
Test No. 18 Over-all frequency response of entire receiver.	R.f. Signal from generator (externally modulated by variable audio oscillator 20 to 15,000 c.p.s.), and coupled to r.f. input of receiver.	(a) With mod. at 1,000 cycles, obtain same pattern as in test No. 16, measuring audio voltage necessary. (b) Increase audio mod. frequency while maintaining same audio voltage; when response falls off, adjust i.f. trimmers slightly for improvement of high-frequency response.	(Pattern 18) Receiver output at variable audio frequencies. (a) about 1000 cycles. (b) at higher frequency.	Receiver response for mod. frequencies from 20 to 15,000 c.p.s.

ANTENNA PRINCIPLES

Part IV—Commercial FM and Television Antennas

AN ANTENNA is a system of conductors which can radiate an electromagnetic field when supplied with r.f. power. The available power is limited by the efficiency and power input to the final r.f. stage. It cannot be increased by the antenna system, if the latter is already correctly matched to the transmitter. However, it is possible to focus the field

so that most of the power is radiated in useful directions. This is done by using suitable directional arrays.

The first cost of a highly directional (and usually complex) array, and of its erection, is generally far greater than that of a simpler type. The greater expense is justified because the same use-

their use with superheterodynes to receive distant signals. Later they were used in connection with direction finding and airplane communications.

A loop receives and transmits best in directions along its plane (Fig. 1). Its effectiveness decreases progressively as the angle from this optimum increases and is zero perpendicular to the plane. The null is much sharper than the maximum and is generally used in determining directions. The shape of a loop does not matter to any great extent. It may be square, circular, triangular, or any other shape. Choice depends upon simplicity of manufacture feeder arrangement, and other considerations. Loops may be used in combination to concentrate power.

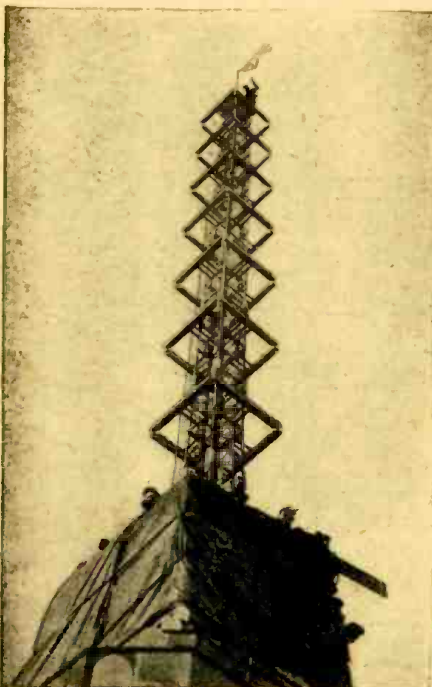

Photo A—Square Loop antenna with gain of 8.

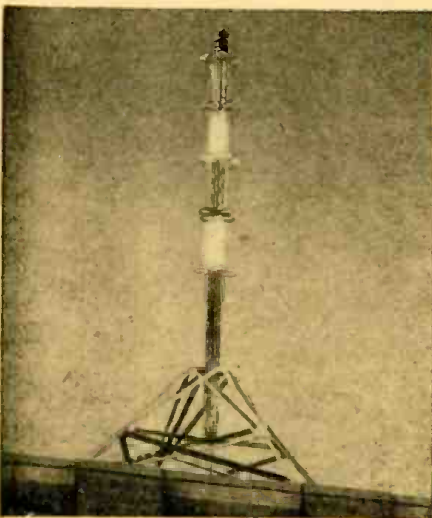

Photo B—The Cloverleaf antenna, used for FM.

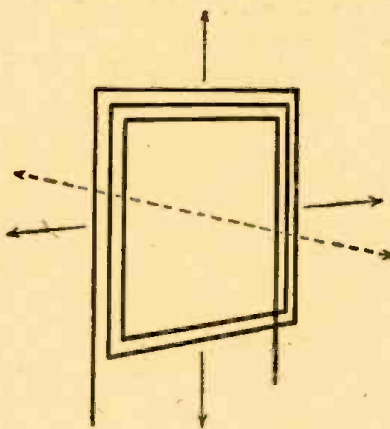

Fig. 1—Directional characteristics of loop.

ful area can be served with a fraction of the input power required by a simpler antenna.

Major research has therefore been directed by many manufacturers toward the design of efficient antenna arrays for FM, television, and facsimile. The two important requirements are:

1—The radiation field must be limited to the horizontal plane. It should be circular so that the same coverage is obtained in all directions toward the horizon. The transmitting antenna can then be located in the heart of the area being served, and the radiated power used with maximum efficiency.

2—The antenna must be capable of radiating the required wide modulation band. The impedance must be matched throughout the band so that no portion of the band will be attenuated or cut off. This is especially important in television. If the antenna impedance changes with frequency, not only will the output be reduced but there will be reflections of power which lead to multiple and spurious images.

The newly designed antenna systems may be grouped as follows: loops, cylinders, and turnstile types.

Loop Radiators

Loop antennas have been known and used since the early days of radio. Their directional characteristics, good pickup, and compact arrangement established

The Square Loop

This antenna (Photo A) is made by Federal Telephone and Radio Corp. It was chosen because of its mechanical ruggedness and simplicity of construction. Each loop consists of 4 end-fed arms. To reduce the Q and thus flatten the frequency response over a wide band, the conductors have a large diameter. This also reduces the impedance so that it is only 1,000 ohms at each end of an arm. The main feeder (coming up

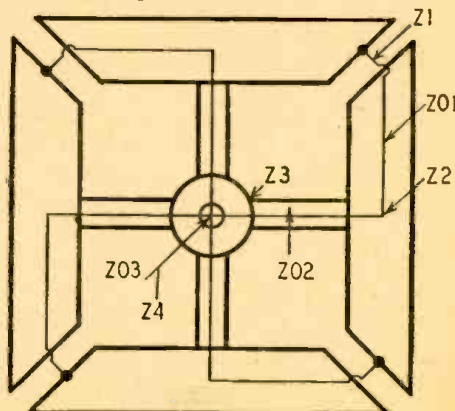
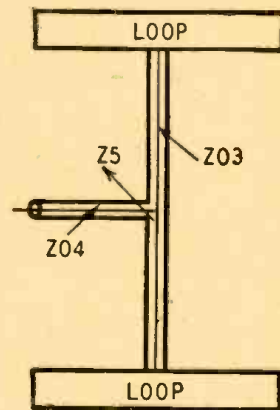

Fig. 2—Impedances of Square Loop antenna.

through the center of a loop) is designed for a standard surge impedance Z_0 of 100 ohms, therefore each branch feeder (Z_3) presents an impedance of 400 ohms, since there are four in parallel.

Any impedance is correctly matched to another impedance when they are connected by a quarter-wavelength of transmission line or cable which has a characteristic impedance equal to the square root of their product:

$Z_k = \sqrt{Z_a Z_b}$, where Z_a and Z_b are the two impedances and Z_k the impedance of the quarter-wave line. In the square-loop antenna the feeder problems are solved as follows. Each branch feeder (400 ohms) must match the impedance of one side of loop Z_1 (1,600 ohms). This is done in two steps.

1— $Z_0/2$ is designed for a convenient and standard characteristic impedance (determined by its cross-sectional dimensions) equal to 50 ohms. Therefore Z_2 should show an impedance of 6.25 ohms, since

$$50 = \sqrt{6.25 \times 400}$$

2—Having determined Z_2 , the quarter-wavelength co-axial cable $Z_0/1$ must be designed to have a characteristic impedance equal to 100 ohms:

$$100 = \sqrt{6.25 \times 1,600}$$

The square loop is mounted in a horizontal position on a vertical mast. For

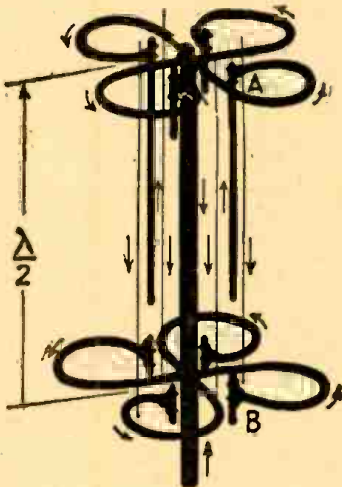

Fig. 3—Electrical design of the Cloverleaf.

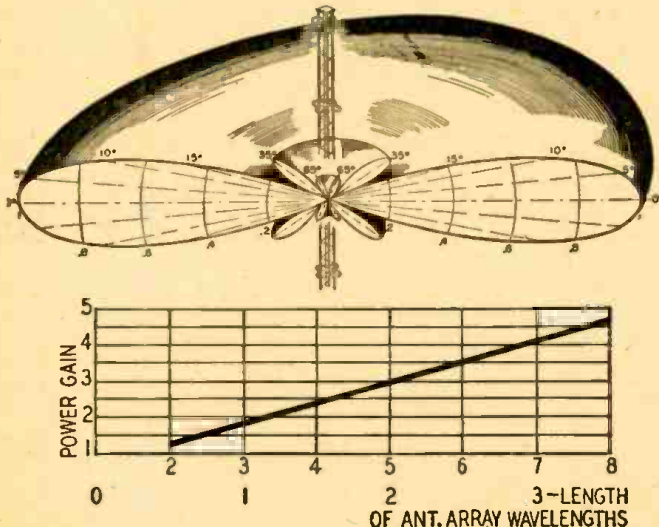

Fig. 4—Field pattern and power gain by units of Cloverleaf array.

greater concentration of power in the horizontal plane, a number of loops are mounted on the same mast, each spaced by a full wave-length and fed in the same phase. Therefore current flows through each loop in the same direction at any instant, and a receiving station intercepts equal amounts of power from each loop.

The Cloverleaf Antenna

This antenna, made by Western Electric, uses radiating loops which are shaped to facilitate feeding and support. See Photo B. Cloverleaf loops are mounted at intervals of a half wave-length along the mast. Each conductor of a "leaf" is supported and fed by a centrally located 3-inch diameter co-axial cable which is clamped to it. The outer extremity of each radiating conductor is supported by vertical members which form the return feed.

It is known that current reverses at half-wavelength intervals along any wire or cable. To compensate for this effect, each adjacent cloverleaf must be physically reversed (Fig. 3) so that the current through each loop may flow in the same direction at any instant. Thus an additive field is produced.

The characteristics of both types of loop radiators (square loop and cloverleaf) are somewhat similar. Fig. 4 illustrates the gain realized from a multiple bay of cloverleaves and the horizontal field pattern of a 5-element array. Since units of a square-loop antenna are spaced twice as far apart as in the cloverleaf the square-loop's gain is approximately twice as great for the same number of units. Fig. 5 shows how the gain increases with the number of loops in a square-loop array.

Cylindrical Radiators

A mast can be used not only as a support but as the actual radiator as well. For mechanical reasons and to reduce the antenna Q (for a wide modulation band) the mast may be constructed of heavy metal tubing with a large diameter. At FM frequencies a typical resonant section of tubing has a height of 13.5 feet, a circumference of 19.5 inches, and a weight of 350 pounds.

A cylindrical antenna may be considered as composed of an infinite number of circular loops each with an opening at one point at which feeding voltage is applied. This is shown in Fig. 6. The length of each cylindrical section is approximately a wavelength and the circumference is half a wavelength. The vertical slot corresponds to a trans-

(Continued on page 66)

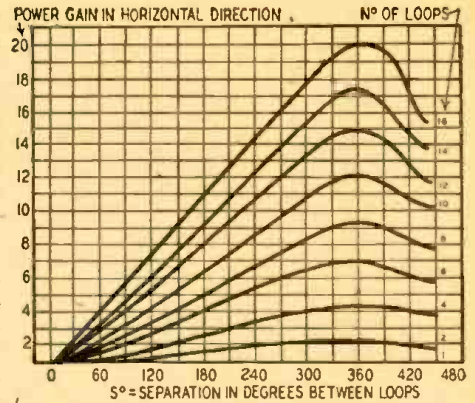

Fig. 5—Gain curves of Square Loop antenna.

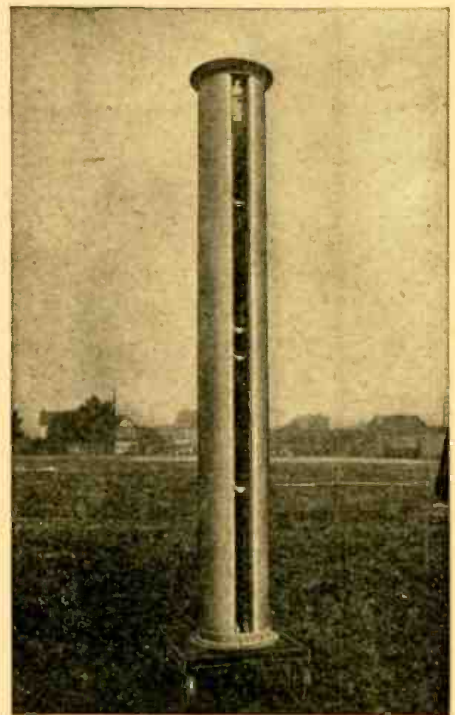

Photo C—Section of Pylon ready to install.

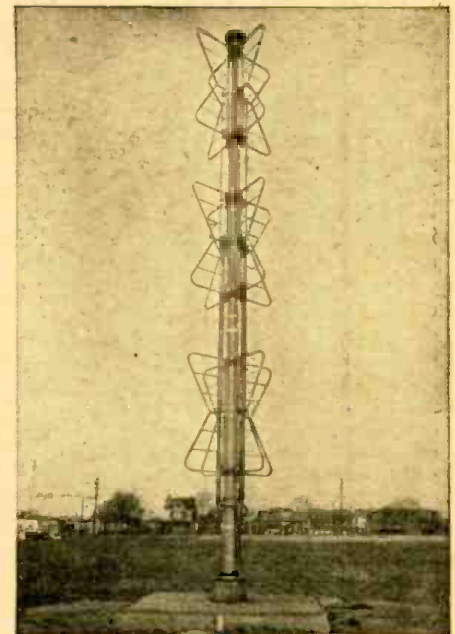

Photo D—The RCA Super-Turnstile antenna.

BUILDING A TELEVISER

Part II—Putting the Video Section into Operation

DATA for aligning the audio section of the televiser were given in last month's issue of RADIO-CRAFT. In this final installment, aligning and operating instructions for the video section are given along with notes on selection and installation of suitable television antennas.

To align the video i.f. stages, connect one lead of the output indicator through a 0.1- μ f capacitor to the output of the video amplifier and the other lead to the chassis. The video i.f. amplifiers must be aligned so that their response curve is similar to that shown in Fig. 1. It is necessary that the response be very small at 8.25 mc to eliminate the accompanying sound i.f. signals from the picture. Similarly the response at 14.25 mc must be very small to keep out sound signals from the adjacent lower-frequency television channel. Note that the i.f. amplifier response at the i.f. frequency, 12.75 mc, is adjusted to be 50 percent of the response over the flat response portion covering most of the desired frequency range.

The first transformer to require adjustment is T4. Connect the signal generator to the grid of V5 through a 50- μ f capacitor. Apply modulation to the signal. While varying the frequency of the signal generator between 8 and 15 mc, note the reading on the output indicator at the various frequencies and adjust the trimmers on transformer T4 until the response roughly corresponds to that shown in Fig. 1. Adjusting trimmer C33 at 8.25 mc will give the high selectivity on the low-frequency side of the response curve. If desired, a rough curve may be plotted between output and frequency as the signal generator is varied from 8 to 15 mc. After transformer T4 has been adjusted, repeat the procedure with transformers T3 and T2, connecting the signal generator in turn to the grid of the second video amplifier tube V4 and then the first amplifier V3. After the rough adjustment of the transformers has been completed, connect the signal generator to the grid of mixer tube V1 and again vary the signal between 8 and 15 mc, at the same time carefully plotting a curve of the over-all response. This curve should be compared with that shown and the alignment touched up as required to make the two curves similar. Video i.f. transformers T5 and T6 are self-resonant and the only adjustment required is to tune the sound traps by adjusting C45 and C49 for minimum output of the video amplifier at 14.25 mc.

After the video i.f. amplifiers have

been aligned, the mixer and oscillator stages must be tuned to the desired channel. This may be done in a manner similar to that used with the video i.f. amplifiers if a high-frequency signal generator is available. The signals should be applied to the antenna terminals of the receiver. Since the antenna circuit is balanced (center tap grounded), the ground lead from the signal generator should be connected to the chassis and the hot lead connected to either antenna terminal through a 50- μ f capacitor. The output indicator should be connected to the video amplifier as previously described. The output of the signal generator should be modulated and set to the sound carrier frequency of the channel being tuned. This will be 0.25 mc lower than the high-frequency edge of the channel. Thus for Channel 2 (44 mc to 60 mc) the signal generator would be set at 59.75 mc. After the signal generator is set, the band switch should be placed in the desired position and the oscillator tuned until the modulation tone of the signal generator is heard in the receiver speaker. Although the signal from the common signal generator is amplitude-modulated, it will be possible to hear it in the FM sound unit. The h.f. oscillator is tuned roughly by varying the spacing between the turns of the oscillator coil. Fine adjustment is made with oscillator capacitor C7. After the oscillator is set, the signal



Fig. 1—Ideal shape of i.f. alignment curve.

generator can be tuned to the carrier frequency of the video signal (55.25 mc for Channel 2) and a series of horizontal black and white bars should appear on the screen of the picture tube. The mixer grid trimmer C2, C4, or C6, for the channel being tuned should be adjusted for maximum output as indicated on the output indicator. The link circuit trimmer C1, C3, or C5 should then be adjusted to give the desired input band width for the channel. Perhaps the best way to adjust both the mixer grid circuit and link circuit is to tune in a station and adjust for the

best picture results. It will be necessary to adjust the mixer grid circuit and the link circuit alternately until the desired band width is obtained or for best picture results. This last method is the only possible method of adjustment if a high-frequency signal generator is not available.

Operating the Televiser

Operation of the receiver is not difficult after the deflection controls have been adjusted and the r.f. circuits trimmed, if necessary. After locating a station, usually by tuning in the sound signal, the height control R60 and the width control R86 should be adjusted so that the picture raster covers the face of the tube as previously described and has a width-height ratio of 4:3. The positioning controls R90 and R91 should be adjusted to center the picture. With the station tuned in, a maze of lines will probably appear on the screen. Adjust the horizontal hold control R76 until a single picture frame appears on the screen. This frame will probably be moving up or down. Adjust the vertical hold control R56 until the picture locks in. Once these controls have been set no further adjustment will be required unless some of the carbon resistors change value through aging.

The focus control R97 should be adjusted to give a sharp picture. Correct adjustment of the contrast and brightness controls, R3 and R44, respectively, will come through experience. The test patterns transmitted by most television stations before starting their programs will aid in the adjustment of these controls. Test patterns usually consist of a series of concentric circles, the circles varying in shades of gray with the center dot black. The contrast and brightness controls should be adjusted so that each of the various shaded circles can be distinguished.

The receiver should always be turned on and off with the brightness control in its *minimum* position. This is to limit discoloration of the screen by keeping the spot on the picture at minimum brightness when it is not being deflected. It will not be possible to eliminate entirely a spot from flashing on the screen when the receiver is turned off because of the type of d.c. restoration used.

Antenna Installation

Several different types of antennas may be used with the receiver. The lo-

(Continued on page 69)

TELEVISION FOR TODAY

Part X—Vertical and Horizontal Synchronizing Circuits

THE clipper stages produce the vertical and horizontal synchronizing pulses. These must be separated and each transferred to its proper synchronizing oscillator. Since both forms of pulses are of equal amplitudes, separation must be based upon their difference in frequency. This is done readily with R-C filters.

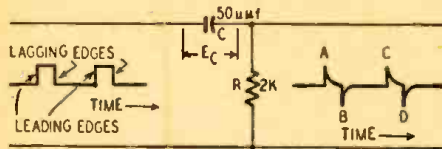

Fig. 1—Effect of high-pass filter on pulse.

A high-pass filter for the horizontal synchronizing pulses is shown in Fig. 1. The square-topped input pulse is applied to the input terminals and a sharply peaked pip A appears at the output terminals. To understand the transition in form, we must consider the action within the network upon the application of the synchronizing pulse.

The initial voltage in the circuit is zero. Upon the application of the leading edge, a short flow of current takes place through the resistor, charging the condenser to the applied voltage. The length of time required to charge the condenser depends upon the time constant ($R \times C$) of the combination. In the horizontal system, the time constant is kept short, permitting the condenser to charge (and discharge) quickly.

The form of the pulse across the resistor is determined by the short time constant and the fact that voltage across a condenser cannot change instantaneously. When the voltage is initially applied across the input terminals, E_c is zero and the resistor receives the full input voltage. The current flowing through the circuit exponentially charges the condenser and lowers the resistor voltage. When the condenser potential equals the applied voltage, current flow ceases. There is no voltage across the output terminals until the lagging edge is reached. At the instant the input voltage decreases to zero, we have the electrical equivalent of a short circuit across the input terminals. The voltage across the condenser is thus placed across the resistor, but in opposite polarity to previous resistor potential (pip B). The reversal occurs because the condenser, in charging, received a voltage that opposed the applied voltage. The duration of the discharge will again depend upon the time constant of the filter. Pips C and D are produced by the second input pulse.

Pips A and C are one horizontal line

apart, as are B and D. However, A and B or C and D are less than one line distant and only one of each group is useful in controlling the synchronizing oscillator. In practice the leading edge of each pulse acts as the control, the second pip having no effect.

Thus far, only the horizontal pulses have been considered. Since both forms of pulses are applied across this network, let us determine what occurs when the equalizing pulses (to be explained shortly) become active. At the leading and lagging edges of each equalizing pulse, a pip of voltage will appear across the output terminals. This is shown in Fig. 2-b. Note that two sets of equalizing pips will appear during one horizontal line (Fig. 3) because the spacings of the equalizing pulses are

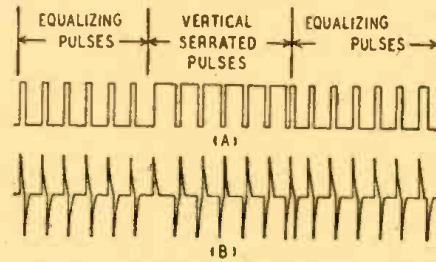

Fig. 2, a—Incoming equalizing and vertical pulses; b—pips at the high-pass filter output,

one-half the horizontal pulses. However, the synchronizing oscillator is so designed as to be unresponsive to any pips except those which occur at approximately $1/15,750$ sec apart.

During the following interval when the long serrated vertical pulses are ac-

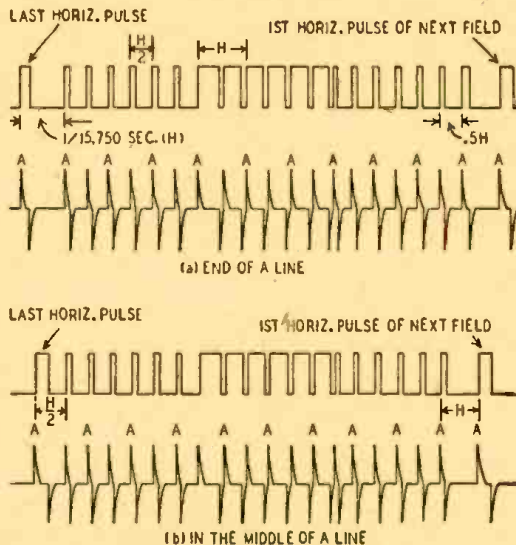

Fig. 3—Conditions during vertical pulses. The pips labelled "A" control the horizontal sweep oscillator.

tive, current flows for a short time in the filter of Fig. 1 only when there is a rise or a decrease in voltage. Throughout the long interval between rise and fall of voltage in the vertical pulse, no output is obtained from the horizontal filter. Therefore the vertical pulse is serrated. Every other serration produces a pip which can be (and is) utilized to control the horizontal oscillator. Thus, there is no loss of control when the vertical pulse is active. In Fig. 3-a, all pips marked A are active in controlling the horizontal synchronizing oscillator. Note that all are evenly spaced, and differ by $1/15,750$ sec. These conditions are found only when the field ends after a full line. Fig. 3-b shows the situation when the field ends on a half line. Note that now the same equalizing and serrated pulse pips are not active in controlling the horizontal oscillator. Because of the difference in field ending, the control has shifted to those intermediate pips which were inactive in Fig. 3-a. However, the shift has in no way interfered with the timing in the control pips. This shift, from field to field, illustrates why all the equalizing and vertical pulses are designed to produce pips twice in one horizontal line interval.

For the vertical pulse separation, the low-pass filter shown in Fig. 4-a is used. From the value of the components we see that the combination has a long time constant. Hence, rapid changes in voltage, such as are obtained from the horizontal and the equalizing pulses, are without effect. The voltage across the condenser begins to build up only during the interval that the serrated vertical pulses are active. At the proper instant, the condenser voltage reaches a value high enough to trigger the vertical synchronizing oscillator.

The purpose of the equalizing pulses can be seen from a comparison of the conditions existing at the start of the vertical serrated pulses after each field. See Fig. 5. In each instance the equalizing pulses are omitted. When the serrated pulses start in the middle of a line, there is some small voltage still remaining on the condenser from the last horizontal pulse. This is not true when the vertical pulses start at the end of a line, for now sufficient time has elapsed since the last horizontal pulse so that the voltage across con-

(Continued on following page)

denser C of Fig. 4-a is zero. Because of this slight but significant difference, the vertical oscillator will trigger sooner in the instance illustrated in Fig. 5-b. The result, visually, is the pairing of lines due to upward displacement of one field

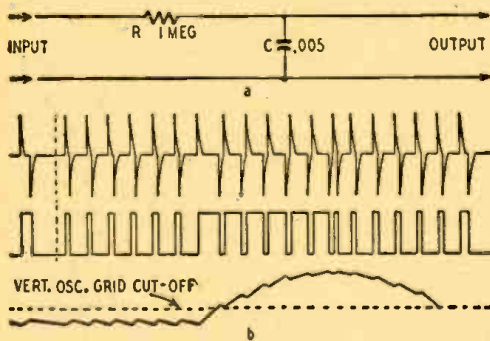

Fig. 4, a—Low-pass filter for separation of vertical from horizontal pulses; b—Waveform of the rise in voltage across the condenser due to vertical pulses.

with respect to the other. With equalizing pulses, the charge on the output condenser before the insertion of the vertical pulses is the same in all instances and the pairing of lines does not occur.

In summary, then, the vertical pulses are inserted into the signal, once in the middle of a line and, in the following field, at the end of a line. The electrical charge on the condenser feeding the vertical oscillator must be the same in each field if identical triggering of this oscillator is to occur. Without the equalizing pulses acting as a buffer, there would be more charge on the condenser when the vertical pulse begins to act in the middle of a line than when it comes at the end of a line. Addition of the charge arising from the vertical pulse to the previous small remainder would cause a premature triggering of the vertical oscillator. To obtain the same triggering, we add the same number of equalizing pulses before every series of vertical pulses. Condenser charge, in all instances before each vertical pulse, will be identical.

Synchronizing Oscillators

Once the pulses are separated, they are fed to their respective oscillators

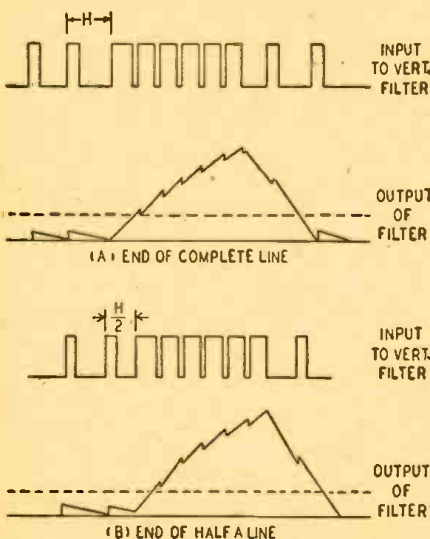

Fig. 5—Difference in voltage before vertical pulse when no equalizing pulses are used.

for control. Each oscillator, in turn, controls the charge and discharge of a condenser which generates the saw-tooth voltage or current. A saw-tooth voltage across a pair of deflecting plates or a saw-tooth current through a deflecting coil will properly guide the electron beam across the face of the cathode-ray tube.

The Blocking Oscillator

Two types of oscillators have been almost universally employed for synchronization; the blocking oscillator and the multivibrator. Not only are these oscillators readily controlled by applied pulses, but they are also characterized by sharp changes in plate current which makes condenser discharging fairly rapid. Oscillators which have current flowing throughout their entire cycle would not be suitable for saw-tooth wave generation.

A blocking oscillator is shown in Fig. 6. Feedback between plate and grid occurs through the transformer. To analyze its operation, consider what occurs when a slight disturbance causes the grid voltage to become more positive. The plate current increases and, if the connections to the transformer are properly oriented, the feedback will drive the grid even more positive. The cumulative rise of plate current and positive grid voltage will continue until grid current flows, charging C1 and quickly biasing the tube to cut-off. Thereafter no current flows in the plate circuit until the accumulated negative charge at the grid condenser leaks off through R1 and R2 back to the cathode. How long this takes depends upon the time constant of the resistors and the condenser. When current is once more permitted to flow, the same rapid rise in current will ensue, once again eventually driving the grid to cut-off. Thus, the frequency of the plate pulses is entirely dependent upon the R-C network in the grid. By making one of these components variable, we can control the frequency of the oscillator.

The control, because of its effect on the image, is known as the hold control. Grid and plate wave forms are also shown in Fig. 6. Note that the plate current rise and fall occurs within a relatively short time interval. Throughout the remainder of the cycle the tube is held beyond cut-off.

To control the frequency of this oscillator effectively, the synchronizing pulses should be applied to the grid just prior to the instant when the voltage on the grid permits the flow of plate current. The point of insertion of the synchronizing pulse is indicated in Fig. 6-b. A sharp positive pulse at this moment will raise the grid voltage above cut-off and start the flow of plate current. If the oscillator free-running frequency is too far off, the synchronizing pulses will be unable to assume

and maintain control. Should this occur, the "hold" potentiometer can be adjusted, until the oscillator can be locked in.

The grid voltage characteristic indicates why voltages reaching the grid of the oscillator during the most negative portions of its path are not effective in synchronizing the oscillator. A pulse must have enough amplitude to bring the grid out of cutoff. Unless this is done, there is no reaction from the oscillator. However, the oscillator becomes increasingly vulnerable to interfering pulses which arrive slightly before the instant proper synchronizing pulse is applied. Such interference will cause a premature triggering of the oscillator, and the following line will be misplaced on the screen.

To generate a saw-tooth wave, using the oscillator, we place the proper condenser in the plate circuit of the blocking oscillator. See Fig. 7. When the tube is cut off, the B-plus voltage of the power supply is applied directly to the condenser through the series resistors. Hence, during the entire interval that the tube is nonconducting, the condenser is slowly charging. If the power-supply voltage is relatively high and the time constant of $R3 + R4$ and C long compared to oscillator frequency, the voltage rise across the condenser will be essentially linear. When the plate current flows again, the rapid rise of positive voltage on the grid reduces the tube's resistance to a small value and the condenser quickly discharges. This will be recognized as the retrace interval that occurs, when the synchronizing pulse triggers the oscillator. Thereafter the tube is cut off and the charging of the condenser starts anew. A variable resistor R4 in the charging path of the condenser permits control of the amplitude of the voltage build-up across the condenser. This, in turn, will regulate the swing of the electron

(Continued on page 60)

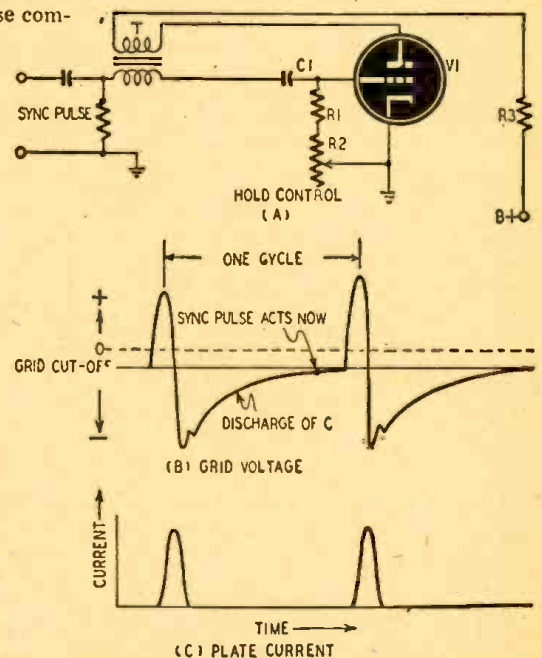

Fig. 6, a—A blocking oscillator; b—grid voltages; c—plate current pulses during one cycle.

WORKING ON 50 AND 420 MC

Two Experimental Transmitters for V.H.F. and U.H.F.



THE WRITER built two special very-high-frequency circuits in 1944 as part of a research project on remote control instruments. Having no idea that these circuits would be of future interest to anyone, photographs of the equipment were not made and the apparatus has since been dismantled. Despite this handicap the material may still be interesting.

The first circuit is for the 50-60-mc band. The second, using one of the latest tube developments, has a range of 400-500 mc. This includes the 420-450 mc amateur band and the new citizens' band. Both circuits stood up very well under exacting conditions, including vibration and shake-table tests, to which they were subjected to determine the amount of abuse the apparatus could withstand. The approximate cost for both circuits is \$15.00, a small investment for the return in knowledge of u.h.f. techniques.

Conventional parts and circuits are used in v.h.f. circuits from approximately 30 mc to 100 mc. However, due to distributed capacity effects, the lengths of leads and the location of components are very important. Above 100 mc, slightly different provisions must be made. In most v.h.f. and u.h.f. applications lumped L-C circuits are replaced by quarter-wave lines along whose length the L and C are distributed, and whose Q is high enough for the desired frequency. For most v.h.f. applications special low-loss insulating materials are used. Power-supply lines become "hot" to r.f. and necessitate much shielding and filtering. The conventional Hartley oscillator becomes troublesome above 50 mc. Filament and plate power-supply cables are "hot" to r.f. (they oscillate), and body capacitance causes the oscillator to change frequency. The Colpitts oscillator is free of this difficulty and provides an economical circuit of very good stability. This points up the theory: "the more capacity in a circuit the greater the stability" (a low L/C ratio means a high Q).

A 50-Megacycle Circuit

Fig. 1 shows this Colpitts circuit. This oscillator uses two 6C4 tubes connected in parallel. Some readers may criticize this arrangement as having more parasitics than a single tube. These are not troublesome. Two 6C4s in parallel form a very stable and practical circuit. The output is between 8 and 10 watts which is adequate for ordinary purposes.

Mobile c.w. operation can be undertaken immediately with a vibrator, dynamotor, or battery pack as power supply. The Electronic Labs No. 605 vibrator, the No. 4201B Radiart vibrator, or the Pioneer E1W272 dynamotor, all operate from a 6-volt storage-battery source and are suitable for this circuit. The filaments of the 6C4 operate on 6.3 volts (a.c. or d.c.).

In time a modulator may be developed from such tubes as the pentodes 6K6-GT or 6AQ5 and added to the oscillator. The 6AK5 is also suitable but manufacturers say that, when present military surpluses of this tube are depleted, it will be hard to get. Miniature-button, 7-pin, bakelite sockets are best (heat from this circuit melts polystyrene sockets). Mount these sockets on the chassis so that their pins clear each other by about 1/8 inch. Miniature shield cans may be used if desired, and one of the small chassis will suffice for operation on c.w. only; a larger chassis can be used if modulation is to be added. To permit the use of the shortest possible leads, orient the sockets so that the grid pins are closest together. The other leads will then be reasonably short, too. The tank inductance

is made up of four turns of No. 18 tinned wire, spaced 3/16 inch on a 3-inch piece of 1-inch lucite (or polystyrene) rod (see Fig. 2-a). If this coil is located in the center of the lucite rod and grooves cut in the rod, by means of a lathe, to a depth of 1/4-inch, the tank inductance can be countersunk into the coil form and the antenna coupling coil, of two turns of No. 16 tinned wire, may be mounted on the outside of the form (Fig. 2-b). Then the coil form can be mounted over the tube sockets as shown in Fig. 2-c. Both these coils are made from bare wire.

If the tank condensers C1 and C2 are mounted in the same plane to clear the coil form by 1/2-inch, all leads will be sufficiently short. Do the necessary tube wiring before mounting the coil form and tank condensers. The fixed condenser should be of the silver ceramic type. The variables were LC1644 Tiny Mites.

Use a lowered plate voltage when ad-
(Continued on page 36)

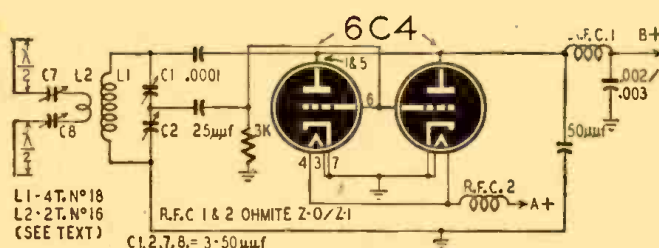

Fig. 1—Circuit diagram of 50-megacycle experimental transmitter.

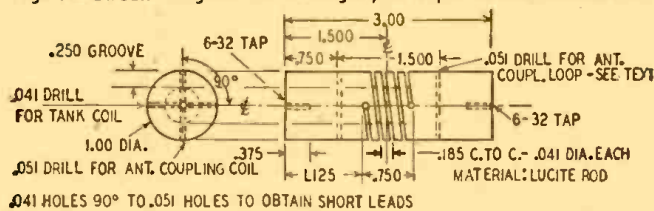

Fig. 2-a—How the tank coil is sunk in the polystyrene coil form.

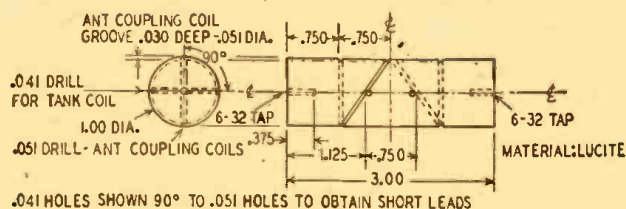
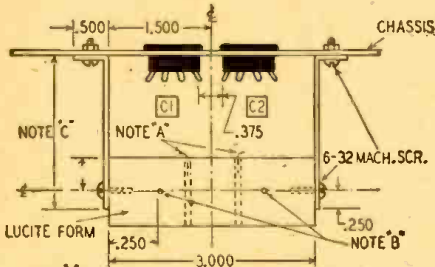

Fig. 2-b—The antenna coil is wound on the surface, over the tank.

justing the circuit. Then gradually increase this to about 260-280 volts with a d.c. plate current of approximately 40 ma. Operating the tubes at 300 volts at 50 ma will reduce their life span.

A number of antenna combinations



NOTES: A—ENDS OF TANK COIL AS SHOWN TO MAKE SHORTER LEADS.
 B—OSC. COUPLING COIL HOLES HORIZONTAL.
 C—ANGLE BRACKETS ARE BRASS .045 THICK, 2.25 X .375 X .250 WIDE.
 C1 & C2 PLACED APPROX. AS SHOWN, FORWARD, TO BE FREE FROM COIL FORM.

Fig. 2-c—Mechanical layout of the 50-mc set.

are available. The one illustrated is conventional for a full-wave antenna. An interesting experiment is to make one section of the antenna $\frac{1}{4}$ and the other $\frac{3}{4}$ and substitute a 25- μ f and a 75- μ f Tiny Mite for the two 50- μ f units.

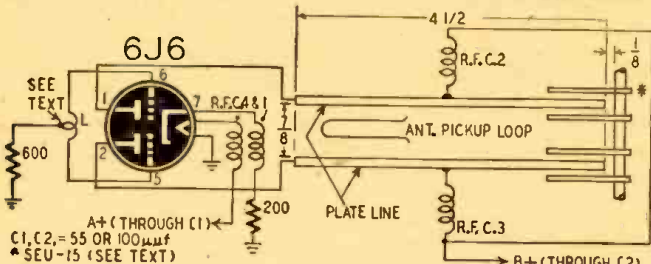

Fig. 3—Special long-lines oscillator circuit for 420 megacycles.

A 450-Megacycle Oscillator

As operation gradually shifted to higher and higher frequencies the 6C4

underwent a change in the laboratories of the tube manufacturers. The result was the development of the 6J6 Twin Triode (see photograph), a miniature 7-pin tube, which is the heart of some of the wartime radar instruments. This tube is now available to the amateur and provides the basis for the second circuit, the foundation of another good ham rig.

The frequency range of this 6J6 oscillator is from approximately 400 to 500 mc. Like the 6C4 this circuit can be used immediately for c.w. operation and the amateur can add a modulator at his leisure. The modulator tubes mentioned for the 6C4 can be used with the 6J6. Plate modulation is conventional in u.h.f. circuits.

The r.f. circuit employing this 6J6 twin triode is shown in Fig. 3. It is a symmetrical push-pull affair. In effect this is a tuned-plate tuned-grid oscillator. A small loop of No. 18 tinned (bare) wire, marked L in the diagram, about $\frac{1}{4}$ -inch in diameter, is used to connect grid pins 5 and 6 of a polystyrene, miniature-button, 7-pin socket. This loop provides the inductance in the grid circuit while the interelectrode capacitance provides the proper L-C ratio. The same analogy holds for the plate circuit; the tube oscillates through the plate interelectrode capacitance and the distributed L-C of the plate lines. The frequency is controlled by means of a capacitive load on the plate lines. The unusual plate lines

consist of pieces of $4\frac{1}{2} \times \frac{3}{8} \times 1/16$ -inch brass strap; their length for the desired frequency range was determined by trial and error. This is a deviation

from conventional plate lines of brass or copper tubing. For ideal operation these plate lines should be silver-plated, but if this is impractical the experimenter must be sure that the strap is thoroughly cleaned before mounting. The plate lines are separated by $\frac{3}{8}$ -inch and terminate in a modified National SEU-15 frequency condenser; other condensers of the SEU series may be used if modified. A standard 180-degree dial attached to the condenser shaft with an insulated coupling permits calibration and tuning by means of a single control.

(Continued on page 57)

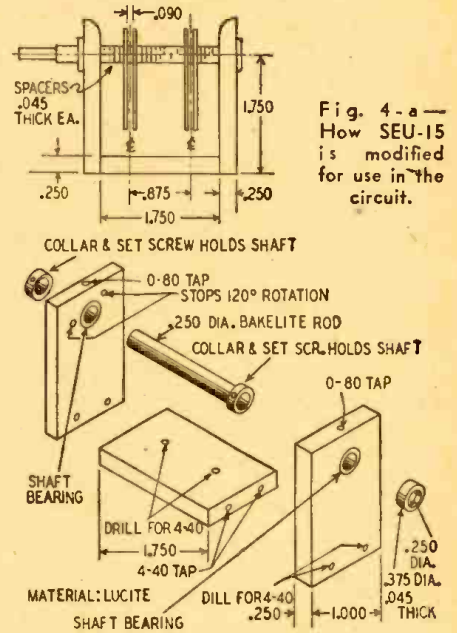

Fig. 4-a—How SEU-15 is modified for use in the circuit.

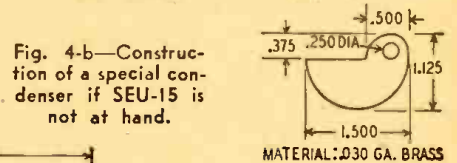

Fig. 4-b—Construction of a special condenser if SEU-15 is not at hand.

A 450-Megacycle Oscillator

As operation gradually shifted to higher and higher frequencies the 6C4

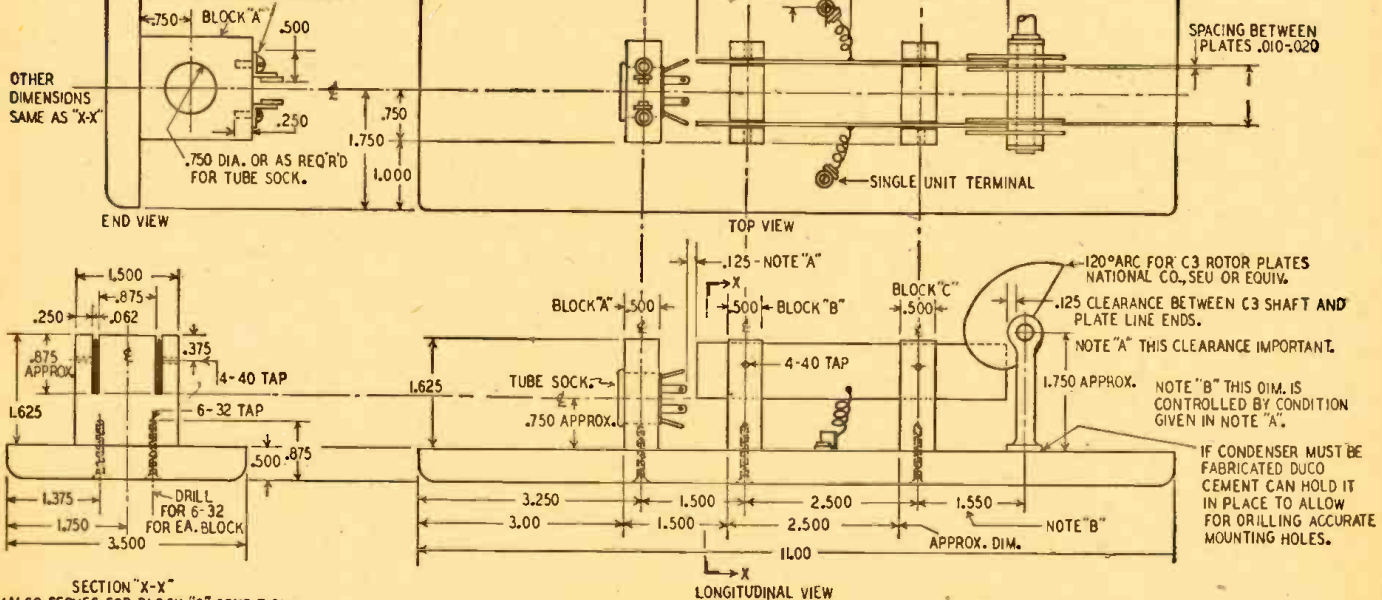

Fig. 5-a (top) and 5-b (bottom)—Top, side, end and sectional views of the 420-megacycle transmitter, showing detail of the long lines.

MULTI-STATION INTERCOMS

Part I — Master-to-Master Systems

INTERCOMMUNICATION systems are useful in many homes and almost indispensable in large offices. Any establishment which needs communication facilities between its various parts is a potential user of an intercom system.

As a spare time venture, making, installing, and servicing intercoms can prove to be both interesting and profitable. They practically sell themselves. This article describes the construction of three different types of systems. Next month's article will discuss installation and trouble shooting.

There are two basic types of intercom systems: the "master-to-master" and the "master-to-remote." In the first type, each station may communicate with any other station. In the second type, there is only one master. It can communicate with any of the other stations or "remotes," but a remote can talk only with the master, not with other remotes. There are many variations of these systems, including both masters and remotes, but only the basic types will be considered.

The most important consideration is always the master station or stations. Its requirements are easily met: 1—utmost possible simplicity, electrically and mechanically, 2—operation from 117-volt a.c. or d.c. mains, 3—use of standard parts only, 4—reliability, 5—reasonably small size, and 6—professional appearance.

The fifth and sixth requirements are conveniently met by the small finished wood cabinets which are available. The photograph shows a master station mounted in a typical cabinet, 7x10½ x4¾ inches, available through jobbers and mail-order houses. While it is not heavily built, it looks good and will stand up well in use. The chassis is made up out of aluminum by a machinist. The cost is higher than for a standard chassis, but its convenience and appearance make up for it. It is entirely practical to cut a piece of metal to size and bend it to form the chassis in the shop, the difficulty depending on the thickness of the metal. Alternatively, a flat piece may be used for the chassis deck and plywood used for the front and rear aprons.

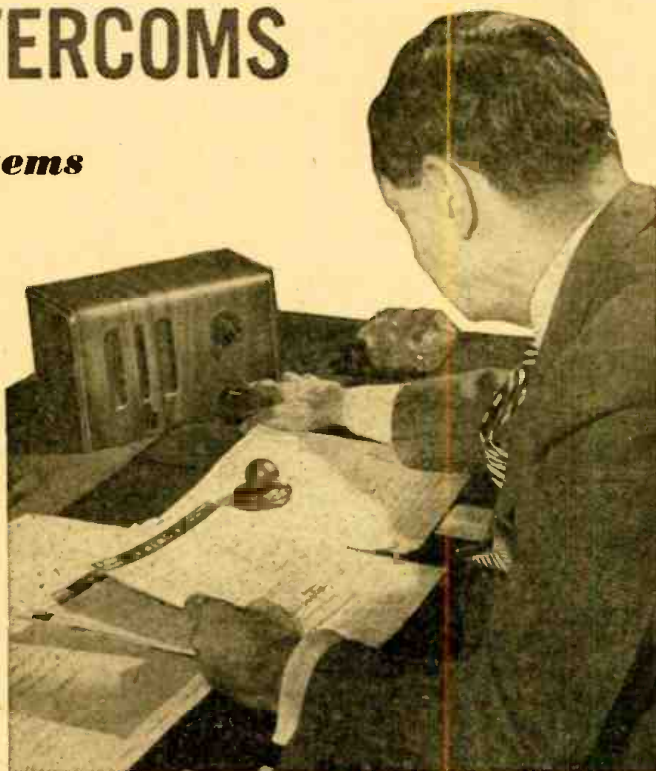

A Master-to-Master System

Fig. 1 shows a complete master station which meets requirements 1, 2, 3, and 4 admirably. It is a 2-tube ampli-

fier powered by a simple half-wave rectifier operated directly from the line. The loudspeaker, as is usual in these systems, acts both as speaker and microphone, and there is a minimum amount of switching for the user.

The 6SJ7 is a voltage amplifier and the 25L6 the power amplifier. The tubes are resistance-coupled. The input transformer primary is 4 ohms, as is the secondary of the output transformer. In fact, the same type of transformer may be used for both purposes, although the special intercom input transformer made by some manufacturers is preferable. If an output transformer is used for the purpose, the highest-impedance plate winding available is best.

No volume control has been included. The volume is about right for most locations and the omission increases simplicity.

No filter choke is used in the power supply. The hum level is surprisingly low with only the filter resistor. Again, space is saved, as well as cost. The series filament resistor is in the line cord. Universal line-cord resistors can be purchased for very small cost and will provide any needed value.

Fig. 2 shows a switching diagram for a master-to-master system, with the amplifiers themselves shown in block form only. This particular system accommodates five stations.

One side of each speaker, input transformer primary, and output transformer secondary is common. These commons are connected together throughout the system and only the "high" side of each need be switched.

(Continued on page 77)

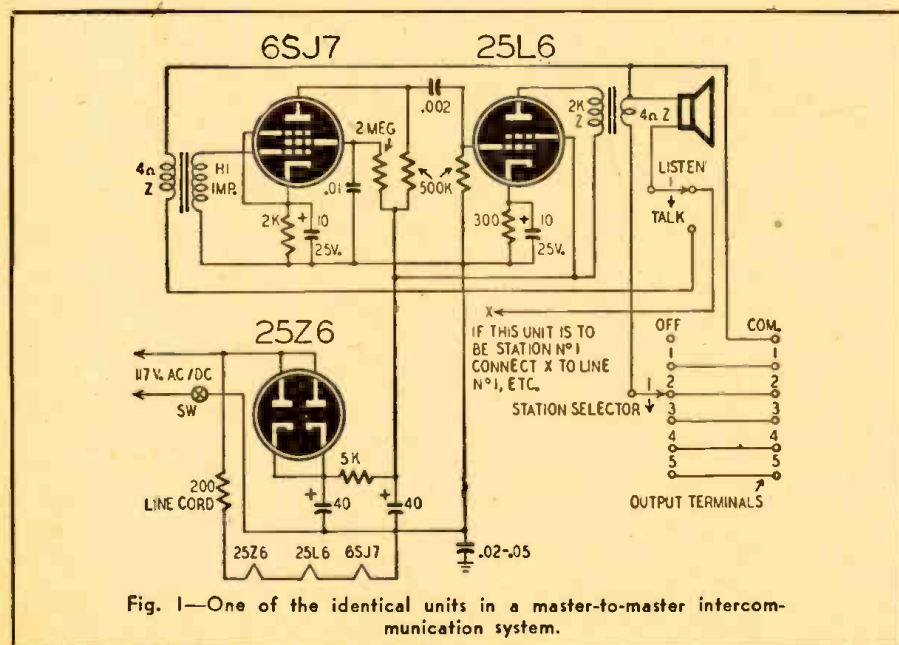
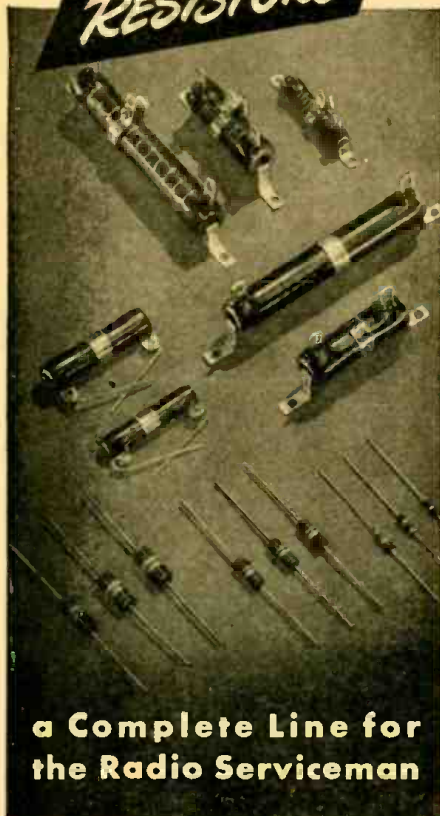

Fig. 1—One of the identical units in a master-to-master intercommunication system.

OHMITE

RESISTORS



a Complete Line for the Radio Serviceman

You can get exactly the type and size you want when you select an Ohmite resistor. Ohmite's extensive line includes Little Devil composition resistors (available only from Ohmite distributors), Brown Devil vitreous enameled wire-wound resistors, and Dividohm adjustable resistors. All are made in a wide variety of resistance values and wattage ratings, with a tolerance of $\pm 10\%$. All will provide trouble-free operation—and complete customer satisfaction.

Send for Catalog No. 19



OHMITE MANUFACTURING CO.
4895 Flournoy St., Chicago, Ill.

NEW Ohm's Law Calculator

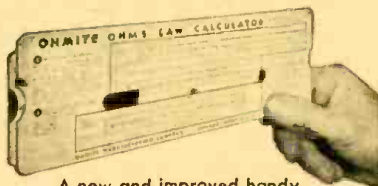

A new and improved handy pocket size (9" x 3") calculator. All computing scales on one side. Shows RMA resistor color code. Only 25c.



Be Right with...

OHMITE

RHEOSTATS • RESISTORS • TAP SWITCHES

WORLD-WIDE STATION LIST

Edited by ELMER R. FULLER

RECEIVING conditions have not been exceptional for the past several weeks, but a few catches are worth mentioning. The Palestine stations have been heard very fine business from 0000 to 0115 and 0500 to 1315 EST, on both 6.135 and 6.170 megacycles. No call is used. The station is located at Jaffa. Another frequency, 11.720 megacycles, is not heard in this country. ZAA in Tirana, Albania, comes in like a house on fire on 7.850 megacycles from about 1445 to 1630 daily. Algiers is heard best now on 11.840 megacycles at 1100 to 1300, and often at 1600 to 1800.

The Antarctic Expedition is being heard on several frequencies. Call used is **NAVE** when their transmission is from the flagship Mount Olympus. Frequencies they intend to use are 17.820, 16.170, 15.940, 12.260, 9.670 and 9.280 megacycles. The first three are used until noon, and the others after noon. Reports on their reception will be greatly appreciated.

Amateurs from all over the globe are being heard on the ten- and twenty-

meter bands, and a few on the eighty-meter band. Any country you wish to mention can be found on either ten or twenty sooner or later.

How do you like the new time system? Do you think it is an improvement over the old method of using am and pm, and often making mistakes when putting it in print? Let us have your views on this. Also, would you be interested in obtaining a short reception dope card each week or two weeks? This was done a few years ago, and we have been thinking of taking it up again. If there is sufficient interest it will be re-established.

This service would be free of charge to active shortwave reporters to this department, would include latest dope on receiving conditions, and would be mailed either every week or every two weeks. If you are interested, drop us a letter. All correspondence should be sent to: Elmer R. Fuller, Shortwave Editor, c/o **RADIO-CRAFT**, 25 West Broadway, New York 7, N. Y.

All schedules are Eastern Standard Time. (24-hour clock system)

Freq.	Station	Location and Schedule	Freq.	Station	Location and Schedule
7.260	JVW	TOKYO, JAPAN: 1500 to 0830.	9.520	VLW7	PERTH, AUSTRALIA: 0530 to 1030; 1700 to 2045.
7.270	VUD8	DELHI, INDIA: 0600 to 0700; 1115 to 1315; 1830 to 1915; 2100 to 2200.	9.520	ZRG	JOHANNESBURG, SOUTH AFRICA: 0300 to 0700.
7.280	VLC8	SHEPPARTON, AUSTRALIA: 1015 to 1045.	9.520	QZF	COPENHAGEN, DENMARK: 1300 to 1800.
7.280	ILW	TOKYO, JAPAN: 0200 to 0800.	9.520	JLU2	TOKYO, JAPAN: 0600 to 1200.
7.290	VUD3	DELHI, INDIA: 2040 to 2245.	9.530	SBU	STOCKHOLM, SWEDEN: 0130 to 0145; 1330 to 1700; 2000 to 2100.
7.290	ZOY	ACCRA, GOLD COAST: 1045 to 1300.	9.540	VLR	MELBOURNE, AUSTRALIA: 1620 to 1900; 2045 to 0230.
7.290		ATHENS, GREECE: 1430 to 1530.	9.540	LKJ	OSLO, NORWAY: 0200 to 0230; 0445 to 1700.
7.300		MOSCOW, U.S.S.R.: 1300 to 1800; 1815 to 2100.	9.540	CJCA	EDMONTON, CANADA: 0815 to 0200.
7.310	YSN	SAN SALVADOR, SALVADOR: 1300 to 1500; 1900 to 2300.	9.540	XET7	ALGIERS, ALGERIA: 1230 to 1700.
7.320	GRJ	LONDON, ENGLAND: 0000 to 0015; 0645 to 0700; 1045 to 1815.	9.550		MEXICO CITY, MEXICO: 0700 to 0100.
7.380	HEK3	BERNE, SWITZERLAND: 1000 to 1045; 1810 to 1830.	9.550		PARIS, FRANCE: 0130 to 0145; 0530 to 0615; 0630 to 0800; 0915 to 0940; 1145 to 1615; 1630 to 1730; 1745 to 1830.
7.570	EAJ43	SANTA CRUZ, CANARY ISLANDS: 0630 to 0800; 1100 to 1200; 1230 to 1800.	9.560		SINGAPORE, MALAYA: 0315 to 0515; 0530 to 1100.
7.640	KUSQ	GUAM: 0400 to 1200.	9.560		KONSDOLSK, U.S.S.R.: 0100 to 0930; 1100 to 1400; 1545 to 1650; 1700 to 1830.
7.850	ZAA	TIRANA, ALBANIA: 1400 to 1800.	9.580	GSC	LONDON, ENGLAND: 1100 to 1315; 1330 to 1415; 1430 to 1530; 1615 to 2300; 2345 to 0030.
7.860	SUX	CAIRO, EGYPT: 1200 to 1600.	9.580	VLG	MELBOURNE, AUSTRALIA: 1100 to 1200.
7.950		ALHAI, SPAIN: 0730 to 0930; 1530 to 1800.	9.590	VUD4	DELHI, INDIA: 0030 to 0100; 0200 to 0400; 0430 to 0515; 0900 to 1230.
8.030	FXE	BEIRUT, LEBANON: 0015 to 0115; 0525 to 0630; 1000 to 1600.	9.590	PCJ	HUIZEN, NETHERLANDS: 1400 to 1500; 1745 to 1815; 2000 to 2200.
8.560	AFN	MUNICH, GERMANY: 0400 to 1200.	9.600	XEYU	MEXICO CITY, MEXICO: 1800 to 2230; 2300 to 0030; 1230 to 1600.
8.700	COCO	HAVANA, CUBA: 0700 to 2320.	9.600	GRY	
8.720	COJK	CAMAQUEY, CUBA: 2000 to 0030.			
8.830	COCQ	HAVANA, CUBA: 0500 to 0030.			
8.950	COKG	SANTIAGO, CUBA: 1830 to 2325.			
9.030	COBZ	HAVANA, CUBA: 0700 to 0100.			
9.080	CNR3	RABAT, MOROCCO: 0100 to 0330; 1300 to 1700.			
9.120		BALIKPAPAN, BORNEO: 0700 to 0835.			
9.160	CR6RB	BENIGUELA, ANGOLA: 1330 to 1430.			
9.180	HEF4	BERNE, SWITZERLAND: 1000 to 1045; 1810 to 1830.			
9.210	H1Z6	CIUDAD TRUJILLO, DOMINICAN REPUBLIC: 0530 to 0830; 1300 to 1530; 1700 to 1845; 1930 to 2230.			
9.230	COBQ	HAVANA, CUBA: 0800 to 1200; 2000 to 2200.			
9.270	COCX	HAVANA, CUBA: 0700 to 0030.			
9.360	EAQ	CENTINE, YUGOSLAVIA: 1830 to 2100.			
9.370	EAQ	MADRID, SPAIN: 1500 to 1700; 1830 to 2100.			
9.380	CDBC	HAVANA, CUBA: 0700 to 2400.			
9.380	OTC	LEOPOLDVILLE, BELGIUM CONGO: 0000 to 0200; 1045 to 1600.			
9.420		BELGRADE, YUGOSLAVIA: 0000 to 1230; 1630 to 0845; 1000 to 1045; 1110 to 1125.			
9.340	HBL	GENEVA, SWITZERLAND: 1300 to 1500.			
9.440	FZ1	BRAZZAVILLE, FRENCH EQUATORIAL AFRICA: 0900 to 0130; 1100 to 2020.			
9.460	TAP	ANKARA, TURKEY: 1000 to 1615.			
9.470	CR6RA	LOUANDA, ANGOLA: 0115 to 0230; 0630 to 0745; 1400 to 1530.			
9.380		MOSCOW, U.S.S.R.: 1500 to 1700; 1830 to 2100; 0000 to 0100; 0530 to 0815; 1100 to 1130.			
9.500	XEWW	MEXICO CITY, MEXICO: 0800 to 0200.			
9.500	OIX2	LWI, FINLAND: 1100 to 1600.			
9.510	JL62	TOKYO, JAPAN: 0300 to 0830.			

RADIO TERM ILLUSTRATED

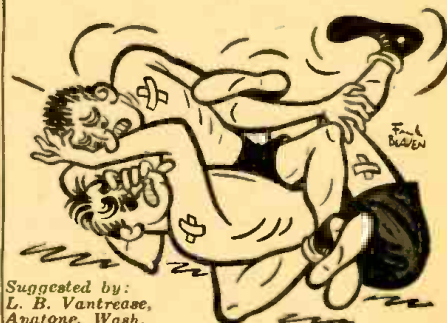

Suggested by:
L. B. Vantrease,
Anatone, Wash.

Twisted Pair

**MOST -
OFTEN -
NEEDED**

RADIO DIAGRAMS



Covering 1946, 1942, 1941, 1940, 1939,] [1926-1938
 Each manual contains between 192 and 240 pages. Price each \$2.00] [This volume \$2.50

RADIO Made Easy
 Home-Study Radio Course
 ONLY \$2.50

Use this 22-lesson radio course to get ahead in radio servicing. New 1946 edition. Complete with self-testing questions, supplementary data, and Index.

You can simplify and speed up all radio repairs with SUPREME PUBLICATIONS manuals. Service radios faster, better, easier, save money and time, use these most-often-needed diagram manuals to get ahead in radio servicing. At unbelievable low cost (only \$2 for most volumes) you are assured of having in your shop and on the job, needed diagrams and essential repair data on 4 out of 5 sets you will ever service. Every popular radio of every make, from old-timers to new 1946 sets, is included. Clearly printed circuits, parts lists, alignment data, service hints are the facts you need to improve your servicing ability. Save hours each day, every day, let these six volumes furnish diagrams for 80% of all sets. See picture of these attractive manuals above. Each volume has between 192 and 240 pages, large size: 8½ x 11 inches, each with index. Manual style binding. Send coupon. Satisfaction guaranteed.

FIX ANY RADIO
 Amazing New Invention

New revolutionary different COMPARISON technique will permit you to repair radios in minutes instead of hours. Charts, blue-prints, hints, ideas, cross-reference circuit suggestions help you to locate all faults instantly. New edition.

Compiled by M. H. Beitman, radio engineer, teacher, author & serviceman.

See Your Radio Jobber or Send



NO RISK TRIAL ORDER COUPON

SUPREME PUBLICATIONS, 9 S. Kedzie Ave., Chicago 12, ILL.

Ship the following manuals: (Money back guaranteed)

1946 1942 1941 1940 1939 1926-1938

Price each volume only \$2.00, postpaid \$2.50] [

Radio Servicing Course-Book, \$2.50

Simplified Radio Servicing by Comparison, \$1.50

I am enclosing \$..... send postpaid.

Send C.O.D. I am enclosing \$..... deposit.

Name:

Address:

Supreme Publications
 PUBLISHERS OF RADIO BOOKS, MANUALS, AND DIAGRAMS

9.610 ZRL	CAPETOWN, SOUTH AFRICA: 0300 to 0700; 0900 to 1030.	9.830 COBL	HAVANA, CUBA: 0715 to 0045.	10.730 VQ7LO	NAIROBI, KENYA: 0500 to 0600; 0830 to 0915; 0945 to 1100.
9.610 ZYC8	RIO DE JANEIRO, BRAZIL: 1500 to 2200.	9.860	MOSCOW, U.S.S.R.: 2200 to 0200; 0830 to 0930; 1000 to 1200.	10.780 SDB2	STOCKHOLM, SWEDEN: 1100 to 1720.
9.610 VLC8	SHEPPARTON, AUSTRALIA: 0830 to 1200.	9.900 ZTJ	JOHANNESBURG, SOUTH AFRICA: 0315 to 0715.	11.040 CSW6	LISBON, PORTUGAL: 0900 to 1130; 1230 to 1500; 1600 to 1800.
9.620 XGNC	KALGAN, CHINA: 0400 to 0815.	9.930 SVM	ATHENS, GREECE: 1300 to 1300.	11.090	PONTA DEL GADA, AZORES: 1500 to 1600.
9.610 TIPG	SAN JOSE, COSTA RICA: 0700 to 2330.	9.960 HCJB	QUITO, ECUADOR: 0545 to 0845; 1200 to 2230.	11.630	MOSCOW, U.S.S.R.: 1930 to 0300; 0600 to 0800; 0830 to 1300.
9.620 CXA6	MONTEVIDEO, URUGUAY: 1530 to 2100.	10.000 WWV	WASHINGTON, D. C.: U. S. Bureau of Standards; frequency, time, and musical pitch; broadcasts continuously day and night.	11.650 XTPA	CANTON, CHINA: 0400 to 0915.
9.620 GW0	LONDON, ENGLAND: 0045 to 0130; 0200 to 0300; 0600 to 0630; 0700 to 0900; 1045 to 1400; 1700 to 2030.	10.000 XGOL	FOOCHOW, CHINA: 0400 to 1000.	11.680 GRG	LONDON, ENGLAND: 0600 to 0645; 0700 to 0900; 1000 to 1130; 1145 to 1200; 1230 to 1430.
9.630 CKL0	MONTREAL, CANADA: 1600 to 1800.	10.220 PSH	RIO DE JANEIRO, BRAZIL: 1700 to 1800.	11.690 XORA	SHANGHAI, CHINA: 1830 to 2400; 0300 to 0930.
9.640 GVZ	LONDON, ENGLAND: 1500 to 1730; 1800 to 2230; 0100 to 0500.				
9.650 XGOY	CHUNGKING, CHINA: 0630 to 1030.				
9.650 KRHO	HONOLULU, HAWAII: 0400 to 1100.				
9.650	MOSCOW, U.S.S.R.: 1100 to 1220; 2200 to 2235.				
9.670 VUD4	DELHI, INDIA: 0000 to 0130; 0200 to 0400; 0430 to 0515; 0730 to 0745; 0800 to 0830; 0845 to 1230.				
9.680 HVJ	VATICAN CITY: 1200 to 1330.				
9.680 XEQQ	MEXICO CITY, MEXICO: 0700 to 0930.				
9.680 VLB2	SHEPPARTON, AUSTRALIA: 0900 to 1100.				
9.680 EGC	TEHERAN, IRAN: 1200 to 1430.				
9.680 LRAI	BUENOS AIRES, ARGENTINA: 1600 to 1630.				
9.700	FORT DE FRANCE, MARTINIQUE: 0900 to 1245; 1600 to 1610; 1730 to 2030.				
9.710	MOSCOW, U.S.S.R.: 2300 to 0730.				
9.720 PRL7	RIO DE JANEIRO, BRAZIL: 0430 to 0600; 1415 to 1445; 1500 to 2100.				
9.730 XGOA	CHUNGKING, CHINA: 0900 to 1030.				
9.730 CSW7	LISBON, PORTUGAL: 1900 to 2000.				
9.740 OTC	LEOPOLDVILLE, BELGIAN CONGO: 1300 to 2015.				
9.820	VIENNA, AUSTRIA: 2345 to 2030.				
9.820 GRH	LONDON, ENGLAND: 1215 to 1600; 1700 to 2300.				

FCC SETS UP RULES FOR CITIZENS RADIO BAND

Citizens radio has been put on an established basis with the issuance of a set of regulations and specifications by the Federal Communications Commission. Two types of transmitters are contemplated: Class A, with a frequency deviation of not more than .02 percent; and Class B, with a frequency deviation not greater than 0.2 percent. Class A transmitters will probably be permitted in any part of the 460- to 470-mc band, unless 460-462 megacycles is reserved to fixed stations. Class B transmitters are to be adjusted to operate on a frequency within 0.2 percent of 465 mc. Controls for frequency adjustment shall be accessible from outside the case unless specifically approved by the FCC. Power is limited to 50 watts, and the bandwidth of a transmitter to 200 kc. No manufacturer has yet reported success in constructing equipment suitable for use in the band, but it is felt that the setting up of specifications by the FCC will hasten research in this direction.

LET THIS "AUTOMATIC TEACHER" show you exactly how to repair over 4800 RADIO MODELS without expensive test equipment!

GHIRARDI SAVES YOU TIME — HELPS YOU MAKE MONEY

Ghirardi's RADIO TROUBLESHOOTER'S HANDBOOK is the ideal manual to show you exactly how to repair radios at home in spare time—quickly and without a lot of previous experience or costly test equipment. It contains MORE THAN 4 POUNDS OF FACTUAL, time-saving money-making repair data for repairing all models and makes of radios better, faster and more profitably than you may have thought possible!

NOT A "STUDY" BOOK

RADIO TROUBLESHOOTER'S HANDBOOK can easily pay for itself the first time you use it. You don't have to study it. Simply look up the make, model, and trouble symptom of the Radio you want to repair and go to work. No lost time! Clear instructions tell exactly what the trouble is likely to be—EXACTLY how to fix it. Actually, this big 744-page manual-size HANDBOOK brings you factual, specific repair data for the common troubles that occur in practically every radio in use today—for over 4800 most popular models of Home and Auto radio receivers and Automatic record changers of 202 manufacturers! In addition, there are hundreds of pages of helpful repair charts, tube charts, data on tuning alignment, transformer troubles, tube and parts substitution, etc., etc.—all for only \$5 (\$5.50 foreign) on an UNRESERVED 5-DAY MONEY-BACK GUARANTEE!



744 manual-size pages

Get a Complete RADIO-ELECTRONIC SERVICE EDUCATION AT HOME—WITHOUT AN INSTRUCTOR

COMPLETE DATA ON TEST INSTRUMENTS—TROUBLESHOOTING—REPAIR

A. A. Ghirardi's big 1300-page MODERN RADIO SERVICING is the finest, most complete instruction book on Radio-Electronic service work for either the novice or the professional Radio-Electronic serviceman—bar none! Read from the beginning, it is a COMPLETE COURSE IN SERVICING by the most modern methods. Used for reference, it is an invaluable means of brushing up on any servicing problem.

Gives complete information on all essential service instru-

ment types; how they work (with wiring diagrams), when and why to use them; how to build your own; preliminary trouble checks; circuit and parts analysis; parts repair, replacement, substitution; obscure radio troubles; aligning and neutralizing; interference reduction—and hundreds of other subjects including How to Start and Operate a Successful Radio-Electronic Service Business. 723 self-testing review questions help you check your progress EVERY STEP OF THE WAY. Only \$5 complete (\$5.50 foreign.)

(You Can't Go Wrong on a Ghirardi Radio Book!)



1300 pages. 706 illus. 723 review questions

5-DAY MONEY-BACK GUARANTEE

Technical Division, MURRAY HILL BOOKS, INC., Dept. RC-37, 232 Madison Ave., New York 16, N. Y.

Enclosed find \$..... for books checked or send C.O.D. (in U.S.A. only) for this amount plus postage. If not fully satisfactory, I may return the books at the end of 5 days and receive my money back.

MODERN RADIO SERVICING \$5 (\$5.50 foreign)

RADIO TROUBLE-SHOOTER'S HANDBOOK \$5 (\$5.50 foreign)

Special MONEY-SAVING COMBINATION Both big books for only \$9.50 (\$10.50 foreign)

Name

Address

City & Dist. No.

State



MONEY-SAVING OFFER!

Get BOTH big books — Radio's most famous Service Library — over 2030 pages — at a bargain combination price. See coupon.

NEW RADAR FOR AIR SAFETY

(Continued from 22)

the aircraft regardless of barometric pressure is also important. Lack of such information has caused many a crack-up. At airports which cannot afford blind landing facilities, it can be used in conjunction with beacons for emergency blind approaches.

In coastal or lake regions this radar will provide a map of the terrain below which can be interpreted by a relatively unskilled observer. In less distinctive terrain it can provide an accurate "fix" anywhere and under all conditions of visibility when used in conjunction with ground beacons.

An outstanding feature of the new and improved model now in process of development will be its gyroscopically stabilized antenna: the picture presented to the pilot will not be affected as the plane banks, climbs, or dives. This refinement is expected to remove one of the main limitations to general use of the equipment during maneuvering flight.

Commercial operators would like to perfect airborne radar to the extent that it would see mountains even in the midst of intense storms, would pick up other airplanes, and even individually identify the large Manhattan skyscrapers. This is regarded by electronics engineers as the ultimate. This ultimate is some years away and may never be completely attained.

famous for GREAT VALUES

ELECTRONIC VOLT OHMMETER

Can measure AC or DC voltage to 1000 in six ranges. Ohmmeter measures to 1000 megohms. An accurate measuring device housed in an oak cabinet measuring 7 1/2" x 10 1/2" with a 4 x 4 1/2" meter. Price only \$28.75

VOLTMETERS 0-30 volts DC. 2" dia. scale having a 0 to 1 M.A. movement. Price \$1.45

MALLORY LINE FILTER—useful in eliminating noises from offending electrical appliances by installing the filter at source. Compares favorably with filters listing at \$10.00. Your cost \$3.45

COAX CABLE RG 5/U—52 ohms per foot impedance, double shielded 1/4" O.D. Price per 100 ft. \$4.25

KIT of 100 assorted size insulated resistors mostly 10% up to 2 watts. Price \$1.25

KIT of 25 assorted meter resistors 1% Price \$1.25

KIT of 25 assorted wire wound resistors up to 100 watts. Price \$1.95

All prices are F.O.B. New York City.

Write for our new catalogue showing new test equipment, tubes and a large variety of new replacement parts. We ship anywhere promptly.

RADIO DEALERS SUPPLY COMPANY

135 LIBERTY ST., NEW YORK 6, N.Y.

TRANSATLANTIC NEWS

From our European Correspondent, Major Ralph Hallows



THE recent de Forest number made no mention of one of the least known of de Forest's innumerable achievements. It will come as a surprise to many to know that the first talkies were made not in Hollywood or by anyone whose name is normally connected with the films, but in England by Lee de Forest! It was back in 1925 that de Forest brought his electric recording apparatus and camera synchronizing gear to England, where he started a small organization called Phonofilms at Clapham in London. A good many short talkies were made, but neither de Forest's genius nor his three-electrode tube were sufficient to surmount the formidable difficulties of those early days. External noises, faulty synchronization, and poor reproduction—not surprising in those days of reed-driven loudspeakers and a.f. circuits coupled by “peaky” transformers!—slaughtered these early attempts. Nevertheless, de Forest has a double claim to being called one of the fathers of the talkies. Not only did he take an active part in its development in pioneer days, but also he invented the grid-controlled tube, without which talkies could never have existed.

Across the Pond on 50 mc

On Sunday November 24, 1946, at 1616 GMT, T. O’Heffernan, G6GBY, picked up a 50-mc transmission by E. P. Tilton, who operates station W1HDQ, West Hartford, Conn. The two had been working on the 30-mc band, and as conditions promised to be good, a switch-over to 50 mc was made. Reception continued until 1720 GMT, with signals reaching R9. Tilton was heard also by another English amateur, D. W. Heightman, G6DH. O’Heffernan’s station is in the West country, in Devonshire; but Heightman’s is in the East, in Essex.

This is claimed to be the first amateur contact established on 50 mc across the Atlantic. Probably it is; but I certainly heard speech from America in 1940 on a frequency not far away. At the time I was using a u.h.f. set tuned to something well above 40 mc when, to my astonishment, I heard speech for a few seconds between two American stations. At the time I was rather busily engaged in playing my small part in the

Battle of Britain and no diary record was made. Nor did I subsequently succeed in tuning in those transmissions. But the memory is vivid, for it was one of the big thrills of a lifetime.

Wireless Exhibition, 1947

Prior to the war a radio exhibition was held every year in London in the early part of September. The last held was in 1938, for the outbreak of war on September 3, 1939, caused that year’s exhibition to be abandoned. It is always an interesting show and I have had the privilege of walking around and viewing its displays in the company of several Americans distinguished in the electronic field. One of these was the late Dr. C. F. Burgess, of the Burgess Battery Company, and I well remember his enthusiasm over the pentode tube, which was seen at Olympia for the first time. Another was Walter B. Schulte, till recently president of the Micro-switch Corporation of Freeport, Ill. This year the exhibition is to be from October 1 to October 11. If any reader of RADIO-CRAFT is then visiting England, I shall be happy to do all I can toward making his visit interesting and satisfying.

Pulse Modulation

So much has been written and said on the European side of the Atlantic about pulse modulation that anyone who did not know the ropes and was not endowed with a critical mind might easily imagine that the whole future of u.h.f. radio was inseparably bound up with one of its four possible modes: amplitude, duration, frequency, or phase. A

good, sound debunking was needed. It has come from H. L. Kirke, head of the British Broadcasting Company research department, who has been investigating the various systems of pulse modulation as possible means of u.h.f. broadcasting.

I have mentioned before that in this country we shall almost certainly have to adopt in the near future some method of u.h.f. broadcasting. Under the European radio agreements the broadcast-band channels assigned to us are far too few to allow the whole country a sufficient number of alternative programs. Moreover, man-made static is a great and growing menace. The only solution in sight is the use of extensive chains of u.h.f. relay stations, each serving a comparatively small area.

The big problem is which modulation system to adopt before the work of construction is launched—AM, FM, or PM. Field trials on 45 and 90 mc have proved that FM is vastly superior to AM in freedom from interference and in the small field strength needed to give adequate reception. Now careful investigations show that PM appears to be in no way better than FM. Kirke finds that there is no superiority of PM over FM in freedom from noise—that if a single PM transmitter is used to radiate a number of programs simultaneously, it needs a far greater band width and is considerably less effective in noise suppression than several FM transmitters used similarly; and lastly that, if one PM transmitter radiates several programs, cross talk between them is inevitable owing to

(Continued on page 55)

RADIO TERM ILLUSTRATED

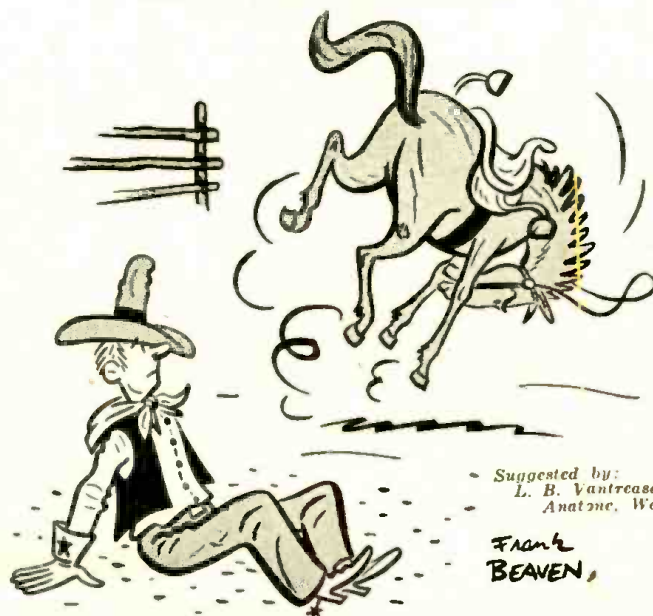

Suggested by:
L. B. Vantrease,
Anatone, Wash.

Franz
BEAVEN,

A Solid Ground Connection

Build a TELEVISION

To stimulate its radio and television training programs, this famous resident radio and television school is offering men interested in television this unusual opportunity.



↑ You can build a direct viewing television chassis similar to the one pictured above, complete with all tubes, including speaker and 7-inch picture tube, right in your own home by following carefully the exact instructions sent to you by this famous television school, located square in the HEART of America's television manufacturing and broadcasting industry. Mail the coupon on the next page to get full details.

→ Here is a typical scene showing an instructor checking the construction completed by the two students in the background.



If you are unable to leave home to go to a resident school, N.Y.T.I. of N.J. can supply you with all the parts to build a television chassis in your own home. You will be supplied with exactly the same instructions and directions with which the school's resident students are equipped, when they reach the stage in their training that calls for television set construction. If you already have a sound radio background, with experience in building radio receivers, you will be surprised to find how much you can learn about television by studying the directions, and building this set.

N.Y.T.I. of N.J. is one of America's leading resident schools in television for men seeking dependable, thorough, up-to-the-minute training in the various fields of radio and television.

The schooling offered by N.Y.T.I. of N.J. is particularly useful to those who recognize the high-earning possibilities of technical training in radio and television and are willing to tackle the class and laboratory work offered.

A grammar school education definitely is required. Moreover, N.Y.T.I. of N.J. requires that a student be earnest, sincere and radio-minded. Students without proper mathematical backgrounds are taught the radio and television mathematics and theory they need.

A considerable number of out-of-

↓ Bob Cohen, shown checking the television set he has built, to make sure there are no engineering inaccuracies.



MAIL THE COUPON TO GET FULL

SET *Right in Your Own Home!*

state students attend the school because of its excellent, practical type of radio and television courses, so difficult to get anywhere else. Living quarters are obtainable by single students. Married students are requested not to bring their families until they can find suitable accommodations for them.

You Put Into Practice Everything You Learn

Students at N.Y.T.I. of N.J. particularly like the way the school puts into practice what it teaches. You may actually build a 17-tube television chassis. You also help build as many as 7 radio receivers of different types, a total of 75 electronic educational devices. Class study and laboratory study, in the proper combination, increase interest—and your hands get as smart as your head.

A 17-tube, experimental, television chassis may be built by all resident students of television, and may be kept as their own property, if they so choose.

Located in the Heart of the Radio, Electronic and Television Industry

The New York Technical Institute of New Jersey is in Newark, N. J., just across the river from New York City (only 20 minutes from Broadway by subway or train). The school is located in the heart of America's great radio and television industry. Such leading television, radio and electronics manufacturers as R.C.A., Western Electric, DuMont, Federal, Westinghouse and Edison are nearby. This means that the school offers numerous advantages, as it is in touch with the most recent developments.

Highly qualified television and radio instructors are here in abundance. Equipment is easier to get. Television students are offered exceptional advantages in this great electronic center.

Coupon Brings Full Information—FREE

The school issues a special Bulletin which illustrates and describes its truly exceptional laboratory facilities and equipment. This Bulletin also describes classes that may be attended, housing conditions, costs, hours, etc. If you are interested in Television—you will want to read this Bulletin. You can have it *free*, merely by mailing the coupon at right.

The school will also be happy to send you complete information about the television kits and directions which are now available to you if you desire to build your own television chassis at home.

Just fill out the coupon at right and mail it NOW to: *New York Technical Institute of New Jersey, Dept. 43, 158 Market Street, Newark, N. J.*



Instructor demonstrating theory of light in connection with study of optical systems used in projection type television receivers.



Big picture television, 16"x21 1/4" "in the flesh" at N.Y.T.I. of N.J. All types of television receivers are available for student use and instruction in the resident school.

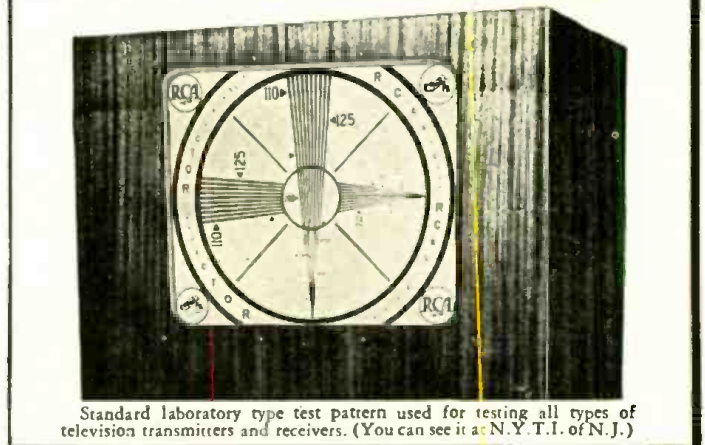

Standard laboratory type test pattern used for testing all types of television transmitters and receivers. (You can see it at N.Y.T.I. of N.J.)

**New York Technical Institute of New Jersey, Dept. 43
158 Market Street, Newark, New Jersey**

- Check here if you wish to receive the Special FREE Bulletin describing the resident school of the New York Technical Institute of New Jersey located in Newark, N. J.—including its facilities, equipment, courses offered, costs, hours, etc.
- Check here if you wish complete information about building a television chassis in your own home.
- Check here if you are a War Veteran.

Name..... Age.....

Address.....

City..... Zone (if any)..... State.....

(N.Y.T.I. of N.J. employs no salesmen to call.)

INFORMATION *Free*

NEW

RADIO-ELECTRONIC DEVICES

MULTI-TESTER KIT

Radio Kits Co.
New York, N. Y.

The Model 120 Multi-Tester Kit is designed to demonstrate ohm-volt-milliammeter construction to students. It has five voltage ranges, three current ranges and three ohm ranges. Sensitive needle and clear dial make for easy reading.

Voltage ranges are 0 to 5, 0 to 50, 0 to 150, 0 to 500 and 0 to 1,500 volts. Current ranges are 0 to 50, 0 to 150, 0 to 500 milliamperes.

Resistance ranges are 0 to 2,000, 0 to 20,000 and 0 to 200,000 ohms.—RADIO-CRAFT

A.C.-D.C. AMPLIFIERS

Altec Lansing Corporation
New York, N. Y.

The new A-319A and A-319B amplifiers are designed to supply 4 watts output when supplied from 105-125 a.c. or d.c. lines.

The A-319A amplifier which comes in a metal wall cabinet, has a balanced bridging input transformer with a 5,000 ohm input designed for bridging across 250-500-600-ohm lines without requiring isolating transformers. Its gain is 50 db from a 600-ohm line.

The A-319B amplifier, normally supplied without the wall cabinet, has a high impedance input for crystal pick-up use. The gain is 57 db from 250,000-ohm line. A wall cabinet must be purchased separately if required.

Both amplifiers have adjustable low frequency boost. The A-319A has an adjustable high frequency boost to compensate for line losses. The A-319B has an adjustable high frequency droop to



eliminate needle scratch. Inverse feedback from push-pull output stage to input stage keeps distortion to a minimum. The feedback is taken from a tertiary winding on the output transformer thus leaving the output ungrounded. The normal output impedance of both units is 8 to 15 ohms.—RADIO-CRAFT

SQUARE WAVE GENERATOR

Maguire Industries, Inc.
Bridgeport, Conn.

The new Square Waver converts the output of audio sine-wave generators into square waves for testing a.f., FM, television and other circuits.

Technical specifications are:

Input: Frequency range—2 to 200,000 cps. Impedance—75,000 ohms. Voltage—6 to 150 volts.



Output: Frequency Range—20 to 20,000 cps waveform square to 1 percent (2 to 200,000 cps total response). Rise Time—1 microsecond to 99 percent of maximum amplitude. Voltage—15 volts maximum peak-to-peak open circuit with continuously variable attenuation 0-60 db.—RADIO-CRAFT

GERMANIUM CRYSTAL

General Electric Company
Syracuse, N. Y.

This new germanium crystal diode has a safe forward current of .05 ampere and a safe back voltage of 60, which makes it useful as a rectifier, modulator, detector or voltage regulator in radio, television and other electronic applications.

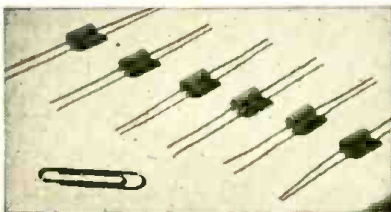

Weighing several grams with a body length of 23/64 inch and diameter of 7/32 inch, the diode has an interelectrode capacitance of approximately .2 µf. Its life performance is at least 3,000 hours.—RADIO-CRAFT

SIGNAL GENERATOR

Bliley Electric Co.
Erie, Penna.

This crystal-controlled oscillator, known as the CCO, employs low-temperature-coefficient quartz crystals, stable to within plus or minus 0.1 percent, to provide direct crystal control, with instant selection, of the five most commonly used intermediate frequencies: 175, 262, 370, 455 and 465 kc.



crystal control is also provided at 200 kc for r.f. alignment and at 1,000 kc for shortwave alignment. An external socket is provided to accommodate special frequencies that may be required. A three-position modulation selector and a five-step attenuator with vernier output control from 0 to 15 volts provide finger-tip operation. Power consumption is 17 watts at 117 volts a.c. or d.c.—RADIO-CRAFT

LADDER ATTENUATOR

The Daven Company
Newark, N. J.

The Type LAC-720 is essentially a ladder network designed so that the



frequency characteristics follow the hearing response of the human ear, with the effect that bass notes have a smaller loss than the middle or upper registers.

By proper external connection to lugs on the terminal board, it is possible to obtain six different attenuation-vs.-frequency curves varying from the human ear type of response to flat. When the unit is wired for a flat frequency response it functions as a straight ladder of 2.5 db per step.—RADIO-CRAFT

FREQUENCY CALIBRATOR

Browning Laboratories, Inc.
Winchester, Mass.

The new Frequency Calibrator Model RH-10 allows full use to be made of the frequency standards transmitted from radio station WWV. It is pre-tuned for 5 and 10 megacycles. Either may be selected at will. Provisions are made for coupling secondary standards or other r.f. sources and comparing their fundamentals or harmonics with the standard frequencies transmitted by WWV. A cathode-ray indicator permits frequency comparisons to be made to at least 1/10 cycle. A dual filter allows the selection of either the 440 or 4,000 cycle modulation. This allows them to be used as a primary standard.

The sensitivity is better than 1/2 micro-volt and the image rejection ratio is more than 50 db and is supplied in a cabinet or rack mounting. Dimensions: 9x19x11 inches. Weight: 30 pounds.—RADIO-CRAFT

DE FOREST TO THE NAB

On more than one occasion Dr. de Forest has expressed something less than absolute satisfaction with the science of broadcasting which he made possible and originated. His most recent expression on the subject was in a letter to the *Chicago Tribune* during the recent convention of the National Association of Broadcasters:

A Father Mourns His Child

In the Palmer House is assembled the convention of the National Association of Broadcasters. There many words are spoken on behalf of a great industry which thrives chiefly on spoken words. Broadcasting depends largely on the tongue and jaw muscles, plus breath, of thousands of men standing before microphones, at so much per syllable.

One wonders if our simian ancestors had any conception that ages later such monkey chatter as they originated could some day be transformed into the essentials of livelihood. Of such are the mysteries of evolution. Today fabulous sums are paid for talk; speech, not silence, has been proven golden; and the dispersers of such merchandise to the millions are here foregathered, to plan for more speech, for more money.

I, who originated the idea, and the means for broadcasting, was not invited to their council. Had I been, I might have said: "What have you gentlemen done with my child? He was conceived as a potent instrumentality for culture, fine music, the uplifting of America's mass intelligence. You have debased this child, you have sent him out on the streets in rags of ragtime, tatters of jive and boogie woogie, to collect money from all and sundry for hubba hubba and audio jitterbug. You have made of him a laughing stock to intelligence, surely a stench in the nostrils of the gods of the ionosphere; you have cut time into tiny cublets, called spots (*more rightly stains*), wherewith the occasional fine program is periodically smeared with impudent insistence to buy or try.

"The nation has no soap, but soap opera without end or sense floods each household daily. Said a man, 'I have to use their alkalizing tablets, their commercials upset my stomach.'

"Murder mysteries rule the waves by night and children are rendered psychopathic by your bed time stories. This child of mine, now 30 years in age, has been resolutely kept to the average intelligence of 13 years. Its national intelligence is maintained moronic, as though you and your sponsors believe the majority of listeners have only moron minds. Nay, the curse of his commercials has grown consistently more cursed, year by year.

"Yet, withal, I am still proud of my child. Here and there from every station come each day some brief flashes worth the hearing, some symphony, some intelligent debate, some playlet worth the wattage. The average mind is broadening, and despite all the debasement of most of radio's offerings, our music tastes are slowly advancing. Some day the program directors will attain the intelligent skill of the engineer who erected his towers and built the marvel which he now so ineptly uses."

LEE de FOREST

RADIO-CRAFT for MARCH,

Just Out!

CONCORD Bargain Catalog of RADIO Equipment FOR Immediate Shipment

Just off the press—48 exciting pages of radio parts, equipment, and supplies for dealers, servicemen, amateurs, maintenance, testing, building and experimenting—Thousands of items NOW IN STOCK and ready for IMMEDIATE SHIPMENT! Big feature sections of Radio Sets, Communication Receivers, Amplifiers, Ham Gear, Record Players and Portables, Record Changers and complete Sound Systems. Page after page of bargains and special values in top-quality standard-make radio and electronic parts.

Mail Coupon NOW for FREE COPY

Mail coupon below TODAY for your FREE COPY of this latest Concord Buying Guide and Bargain Catalog of Radio and Electronic needs you can order for SAME DAY SHIPMENT from complete stocks in Chicago and Atlanta.

CONCORD

RADIO CORPORATION
LAFAYETTE RADIO CORPORATION
CHICAGO 7, ILL. ATLANTA 3, GA.
903 W. Jackson Blvd. 265 Peachtree St.

CONCORD RADIO CORP., Dept. RC-37
901 W. Jackson Blvd., Chicago 7, Ill.
Yes, rush FREE COPY of the new
Concord Bargain Catalog.

Name.....
Address.....State.....
City.....

RADIO-ELECTRONIC CIRCUITS

WHAT IS THE
FREQUENCY OF YOUR
DOLLAR\$?



SUPREME Model 576
Oscillator.

SUPREME Oscillators cannot measure the wave length of your dollars, but they can increase the frequency by which they find themselves stopping in your cash register.



SUPREME Model 561 A.F.
and R. F. Oscillator.

See these and other SUPREME Testers at your Authorized SUPREME Distributor.



OR, write for new catalogue No. 446 for complete details and descriptions.

SUPREME

SUPREME INSTRUMENTS CORP.
GREENWOOD, MISS., U.S.A.

EXPORT DEPT:
The American Steel Export Co., Inc.,
374 Madison Ave., New York 17, N. Y.

RECEIVER CONVERSION

Here is the method I used to operate small a.c. receivers from a 6-volt storage battery. The filament-type rectifier is replaced with a 6X5 and the filter input lead connected to the cathode. The 5-volt winding is unused. (An 0Z4 may be used if the current drain is under 50 ma.) A small 6-volt vibrator is con-

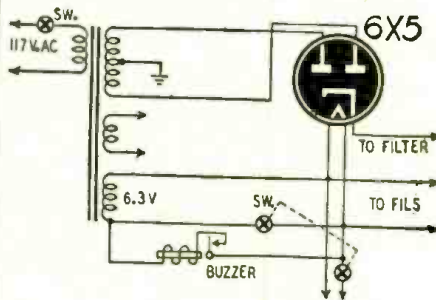

nected in series with the 6.3-volt filament winding with leads running to the battery. A switch shorts the vibrator when a.c. is used. When using a.c., the battery should be disconnected; and for d.c., the 117-volt line should be disconnected. By using a d.p.d.t. switch, the one circuit can be opened and the other closed at the same time.

ALBERT THOMAS, JR.,
Eln Grove, W. Va.

NOVEL TONE CONTROL

Here is a useful tone-control circuit that I have developed for use with my phono amplifier. It consists of high- and low-pass filter circuits fed from a common source and working into the grids of a 6N7. The plates of the tube are tied together to form a mixer circuit. The voltage input to the networks is controlled by the setting of a 1-megohm volume control. A 1-megohm variable tone control determines the amount of

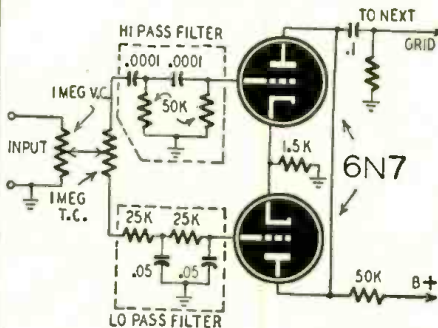

voltage applied to each grid through its filter network.

The values shown in both circuits are sufficient for most applications. However they may be altered, within limits, to suit the constructor.

GEORGE A. FRANCE, W3LTA,
Phillipsburg, N. J.

RECORD PLAYER PRE-AMP

When called upon to install a microphone on a Philco Model RP1 record player, I accepted the job thinking that I could use a small PM speaker and output transformer in place of the pickup. I found that the speaker output was insufficient for full modulation.

The circuit shows a preamplifier that was added to the unit for greater efficiency. The 6J5 socket is mounted between the 6A7 and the power transformer. All leads are brought through the motor mounting hole. The speaker transformer, designed to match the voice coil to a 10,000-ohm, or higher, load, should be placed for minimum hum pickup. A single-pole, single-throw switch across the input circuit will reduce hum when the mike is not in use. Plate and filament voltages are taken from the power supply. This circuit may be used with any phono amplifier having a filament transformer.

If high- μ triodes are used in place of the 6J5, it may be necessary to add

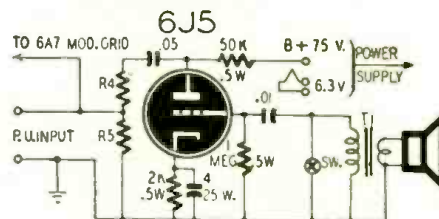

a volume control to prevent overmodulation when talking close to mike.

ORRIN G. WATERS,
Hendersonville, N. C.

MIKE PREAMPLIFIER

Here is a circuit that I use as a substitute for mike battery and transformer. The voltage output from this

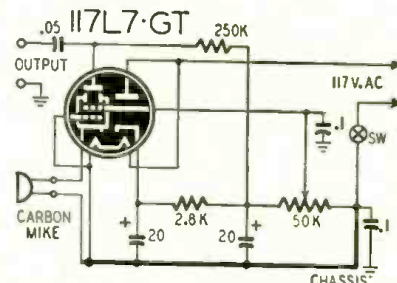

circuit is much higher than it would be from a conventional carbon mike input circuit.

The pentode section of the 117L7-GT is used as a grounded grid amplifier. The variations in the resistance of the microphone create a varying voltage between the cathode and control grid. All ground connections are made to a common bus which is connected to the chassis through a 0.1- μ f condenser. This eliminates a hot chassis. (But not a hot mike!—Editor)

ROBERT J. HALL,
Richmond, Calif.

TRY THIS ONE

SPEAKER KINK

Here is a method that I use for re-centering speaker voice coils when they cannot be centered by any other means. I apply 3 radiating rows of speaker cement, about $\frac{1}{4}$ inch wide, on the side of the cone where it is rubbing the pole

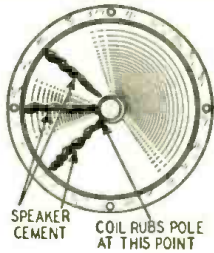

piece. The cement is warmed so that it will dry quickly. The drying cement shrinks the cone on one side and re-centers the voice coil.

WALTER C. WILLIAMS,
Youngstown, Ohio

(If shims are put in place before the cement is applied, a better job of centering can be done.—Editor)

12-VOLT SUPPLY

Here is a circuit that I find useful for mobile operation of a surplus radio transmitter designed for operation from a 12-volt vehicular storage battery. A spare 6-volt battery is placed in the vehicle and connected to a d.p.d.t. switch used to connect the two batteries either in series or in parallel. When they are

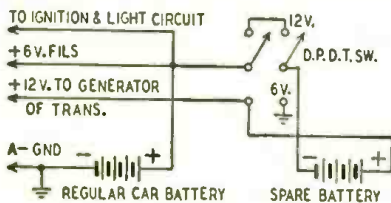

connected in series, the transmitter generator may be operated at full power. In the parallel connection, the generator will operate at reduced power and the spare battery is useful as a reserve power supply for starting on cold mornings. This connection also permits the automobile generator to recharge the spare battery.

A heavy-duty knife switch, capable of carrying 50 amperes, should be mounted on the fire wall or near the battery. A choke lever may be installed to operate the switch from the dashboard. Heavy leads should be used in the battery wiring to prevent excessive voltage drop.

ZOLAN T. BOGAR, W3CJM,
Laurel, Maryland

CABLE BREAK DETECTOR

Practically all experimenters and servicemen have had trouble locating a break in a long piece of insulated wire or cable. While in the Navy, we found

that this may be done simply with a radio receiver and a signal generator.

An antenna will suffice if a strong signal can be tuned in.

A single turn of wire is wound around a nonmetallic cylinder large enough to pass the questionable cable. One end of the loop is connected to the antenna post of the receiver, and the cylinder is anchored so that the wire may be passed through it quickly and easily. One end of the cable is connected to the signal generator or a good antenna. The receiver is tuned to a strong signal or to the frequency of the signal generator. As the free end of the cable is passed through the loop, the signal from the receiver will be equally strong on either side of the break with a definite atten-

RADIO-CRAFT wants original kinks from its readers, and will award a one year subscription for each one published. To be accepted, ideas must be new and useful. Send your pet short-cut or new idea to RADIO-CRAFT today!

uation or null when the break is within the loop. If multiwire cable is used, each end of the normal wires should be grounded.

D. W. BAIRD,
Ashland, Wis.

SOLDER PENCIL

Soft wire solder can be handled more conveniently and easily in the pencil-type holder shown.

The barrel of the holder is a 6-inch length of $\frac{1}{2}$ - or $\frac{3}{4}$ -inch copper tubing. A tapered wooden dowel is wedged into one end of the tube and drilled with a hole slightly larger than the diameter of the solder.

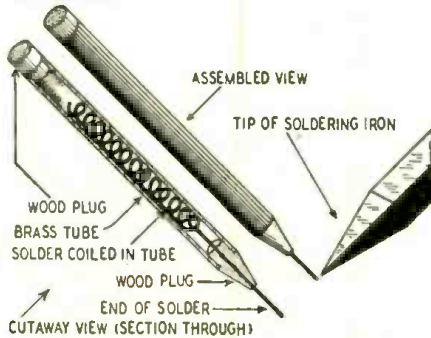

The solder is formed into a spring-like spiral by winding it around a pencil or small rod, leaving a short straight projection. The solder is loaded into the open end of the holder so that the projection will pass through the hole. When the pencil is used, the solder is pulled down as needed.

E. H. STUTZ,
Cleveland, Ohio

(Is there no way of using an old mechanical pencil for the barrel?—Editor)

BEAM ANTENNA INDICATOR

This circuit is a direction indicator for rotary beam antennas. It consists of small electromagnets spaced every 120 degrees around a pocket compass, and is driven by variable currents supplied from a 6-volt battery in series

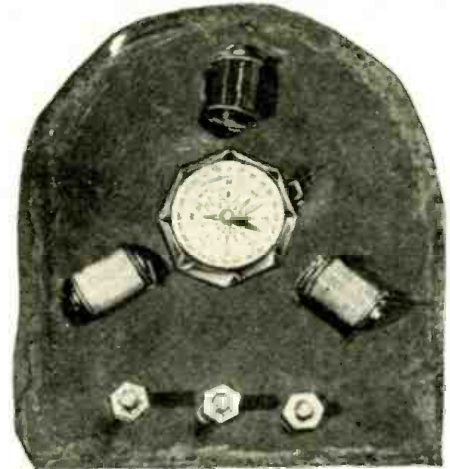

with variable resistance. This resistance is a 500-ohm center-tapped potentiometer coupled to the rotating shaft of the antenna. The magnet coils are connected so that a portion of the potentiometer resistance is in series with the battery.

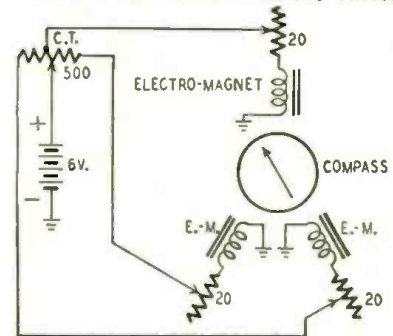

The resistance in the coil circuits depends on the setting of the resistor arm. The coil having the least circuit resistance will draw most current, thus creating the strongest magnetic field.

The coils for the electromagnets are salvaged from a doorbell or buzzer or may be wound by hand on a suitable core. Calibrating 20-ohm wire wound rheostats are inserted in each circuit to equalize the strength of the magnets.

The 500-ohm potentiometer selected should have a wide rotation arc and a linear taper. The coils are spaced equidistant around the compass but should not be placed closer than one inch from the case.

HERBERT L. HARDY,
Buffalo, N. Y.

(An excellent and accurate direction indicator may be made by winding a special circular resistor and tapping it at points exactly 120 degrees apart, in place of the potentiometer.—Editor)

CONDENSER DECADE

In radio servicing, suspected condensers often are checked by substituting good condensers. This may necessitate searching through a drawer full of condensers to find one of the correct value. With a condenser decade, you turn

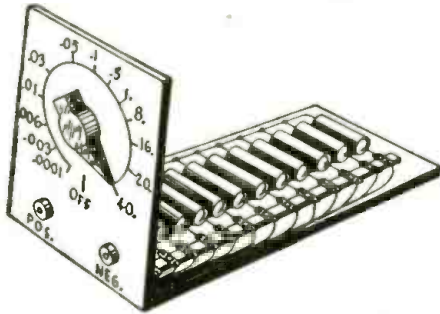

a pointer to the correct value and connect test leads into the circuit.

This decade uses a 14-position switch and 13 condensers of standard values. The switch is mounted on the front panel and the condensers on 2 terminal strips. The negative sides of all condensers are tied to the negative pin jack on the panel. The positive leads are connected to points on the switch. The switch selector arm is connected to the positive pin jack.

MARVIN R. SOLOMON,
Alexandria, Va.

RECEIVER PANEL

After constructing several small receivers, I realized that most of them used the same parts mounted on the front panel. I decided to build a "per-

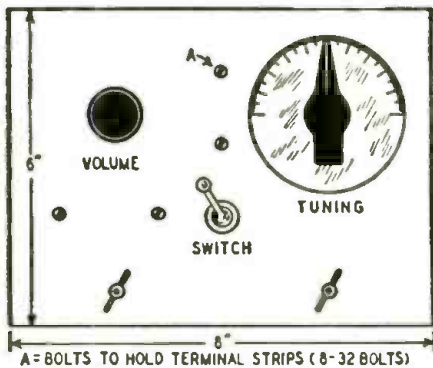

petual panel" that could be used for all future circuits.

A 6 x 8 inch piece of Masonite was selected for the panel. A 350- μ f variable condenser, s.p.s.t. switch, and a 50-000-ohm potentiometer were mounted on the panel. Connections between the controls and the chassis are made by terminal boards mounted near each of the components. The panel is fastened to the chassis with two bolts and wing nuts.

REAL BRONSARD,
Grand Mere, P. Q.

SOLDERING TIP

The tip of a soldering iron may be kept bright by fastening a small suede shoe brush to the work bench so that the tip of the iron may be rubbed over the wire bristles of the brush each time it is used.

JOHN ZACHAZEWSKI,
Northampton, Mass.

SILVER "VOMAX"



IMITATION . . .
SINCEREST OF
FLATTERY

The true worth of "VOMAX" is proven not alone by overwhelming preference by service technicians, by research laboratories. It gets top rating through the copying of its new inventions by at least four manufacturers! No imitation provides the range, utility or value, salinity exclusive to "VOMAX". Recognized by those "in the know", sales of "VOMAX" far exceed those of any would-be competitor. So, cost to you of the genuine, original "VOMAX" is from 10% to over 65% lower than its imitations. Only \$59.85 net.

So superior as to be imitated, "VOMAX" stands unequalled. It alone gives you the astronomically high meter input resistance so necessary to servicing AM, FM and TELE receivers — a feature not obtained by imitations. Add a total of 51 voltage, current, resistance and db. ranges. That's why "VOMAX" is the overwhelming choice of experts — be it for use or copying. Can you afford less than the best — when the best costs you least?

"SPARX"

"QUICKEST TROUBLE
FINDER EVER"

says J. P. FITZGERALD



of his new "SPARX" visual-audal dynamic signal tracer, writing from Madison, Wis. "I cannot afford to be without this valuable instrument one minute. It is the quickest trouble-finding apparatus I have ever used. To repair any radio you've first got to find the trouble. "SPARX" will locate r.f., i.f., a.f. trouble in 30 seconds per tube! Think what that means in profits to the thousands of your competitors already using "SPARX". It will boost your profits, too.

"SPARX" is the same great "buy" at only \$39.90 as "VOMAX" — world's most popular, most copied, universal vacuum-tube voltmeter. Of matching size and style, thousands in use prove its vital worth to every service technician interested in guarding his profits. "SPARX" traces signals through a receiver from antenna to speaker, circuit by circuit, locating trouble points, both audibly and visually. Its speaker switches to panel jacks for shop test use — another SILVER plus-value.

Send Post Card for Catalog for new measuring equipment, communication receivers, transmitters, kits, parts. See them at your favorite Jobber.

OVER 36 YEARS OF RADIO ENGINEERING ACHIEVEMENT

McMurdo Silver Co., Inc.

1249 MAIN ST., HARTFORD 3, CONNECTICUT

SAVE! ON THESE AND THOUSANDS OF OTHER BARGAINS IN STOCK FOR IMMEDIATE DELIVERY

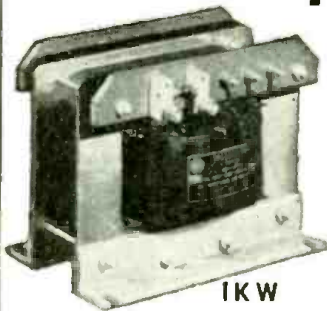

1KW
Modulation Transformer
SPECIALLY PRICED AT **\$14.95**

We have a real value in a modulation transformer. This item, made by RCA TO BROADCAST SPECIFICATIONS, is conservatively rated at 550 Watt audio to modulate that one KW rig. Really rugged construction with protective flashover gaps which are adjustable. Terminals and gaps are mounted on a "Mycelux" terminal board. The laminations that make up this transformer are of high audio quality and are extremely thin, making it impossible for the core to "chatter or talk." Audio Watts—550 Sec. #1—50 Mills Sec. #2—40 Mills Turns Radio—Pri. Sec. #1-1:1 Pri. Sec. #2-3:1 Pri. Sec. #2 Tap-25:1 Impedance Ratio—Pri. #1-1:1 Sec. Pri. Sec. #2-25:1 Pri. Sec. #2 Tap-625:1 DC Resistance—Pri. 135 ohms; Sec. #1 112 ohms; Sec. #2 99 ohms Transformers insulation tested: Pri. 8000V; Sec. #1-11-000V; Sec. #2-2000V. In the rest of the coils and core. Primary center-tapped for Class "B" modulators. Secondary #2 will carry 80 Mills to modulate screens of beam power or screen grid tubes. Primary will match any Class "B" tubes up to 18,000 ohms plate to plate, such as 810's, 757's, 8005's, ZB120's, 203's, HY512's, 211's, 813's, 820's, 805's 2032's. Size 9-5/8" wide, 7-3/8" deep, 7-3/8" high. Heavy channel iron mounting brackets. Weight approx. 40 lbs.—Cat. No. MT-100

Something You Can't Be Without PIN STRAIGHTENER

For miniature tubes—Gov't cost \$4.80 our price—Cat. No. PIO **49c**

MICA CAPACITOR

Mica capacitor .002 MFD 3000 WVDC Cat. No. RT-101 **49c**

IF TRANSFORMER

IF transformer, mounted in aluminum shield can, 1500 KC, with air trimmer, impedance coupled type—Cat. No. T-19 **95c**

30MC IF TRANSFORMER

30 MC IF transformer in square aluminum can, silver slugged tuned—Cat. No. T-20. **29c**



Butterfly Condensers

Ideal for high frequency work.

Type A—frequency range 75 to 300 megacycles to be used with 955 tubes. Cat. No. BC-1

Type B—frequency range 300 to 1000 megacycles to be used with 360AS deorkeeb tube. Cat. No. BC-2

Sockets part of assembly on both.

95c each

Order by Catalog Numbers!

CONDENSERS

CATALOG NO.	CAP. MFD.	WORKING VOLTS	YOUR CDST
C110	1	5000 OIL	\$3.95
C111	3	4000 OIL	\$4.95
C112	1	1000 OIL	44c
C113	4	500 OIL	49c
C114	8	600 OIL	95c
C115	2	600 OIL	49c

VARIABLE CONDENSERS

100 MMFD variable APC type—Cat. No. T-21.	59c
30 MMFD variable APC type—Cat. No. T-22.	25c
12 MMFD variable 1/4" shaft—Cat. No. T-23.	30c

CHOKES

Thordarson 8 HY 150 M choke—Cat. No. FC-201.	95c
Thordarson 8 HY 175 M choke—Cat. No. FC-202.	\$1.49
Thordarson 12 HY 25 M choke—Cat. No. FC-203.	39c
Thordarson 8 HY 350 M choke—Cat. No. FC-204.	\$4.95

Thordarson T48003

Thordarson 2H-7H 550 MA swing choke size 4 1/2" x 5 3/4" x 5 3/4" square blanch castable case. Cat. No. FC-205 **\$5.95**

Filament Transformers

Thordarson 6.3 V—4 amps., 6.3 V—4.5 amp., 9.7 V—5 amp., pri. 110 V AC 25 or 60 cy—Cat. No. FT-11 **\$1.95**

Thordarson pri. 110 V 60 cy.—sec. 6.3 V 6 A, CT—Cat. No. FT-12 **\$1.49**

Thordarson 110 V 60 cy. pri., sec. #1—2.5V 10 A CT, 3000 V ins., sec. #2 10 V 3.25 A, Two 5 V 3 A; 6.3 V 1 A—Cat. No. FT-13 **\$4.95**

All Orders F.O.B. Detroit



Westinghouse meter, 0-1 MA movement, 2" round case, scale calibrated 0-140 and 0-500. Includes mounting hardware. Cat. No. M-101. **\$2.95**



Western Electric meter, 4 RF amps, 2" round case, internal thermocouple, in original box. Includes mounting hardware. Cat. No. M-102. **\$3.95**



Westinghouse meter, 0-1 RF amps, 2" round case, internal thermocouple, in original box. Includes mounting hardware. Cat. No. M-103. **\$2.95**

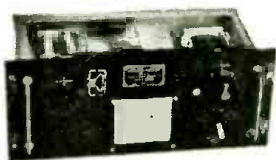

TUNING UNIT

Tuning unit BC 375. Approx. 65 MMFD cond., coils, RF chokes, dials, asstd. mica condensers 2300 WVDC, over \$30.00 in parts. Cat. No. TU-101. **\$3.75**



PHOTO FLASH TUBE

Photo Flash Tube. High speed photo flash tube, 12,000,000 lumens light output. Stops all action. Ignition coil included on back of bulb. 10,000 flashes. Diagrams furnished on request. Your cost Cat. No. PF-101. **\$8.95**

SHALLCROSS ACRA-OHM WIRE WOUND RESISTORS

2,000 ohm	60,000 ohm	±1W 39c each 3 for \$1.00
3,300 ohm	85,000 ohm	
5,000 ohm	75,000 ohm	
15,000 ohm	75,000 ohm	
18,000 ohm	100,000 ohm	
25,000 ohm	150,000 ohm	
30,000 ohm	600,000 ohm	
50,000 ohm		

1 MEG. .89c

SELSYN MOTORS

The ideal way of indicating the position of rotary beams, wind indicator, etc. (400 cycle). Line cord and instructions for 110 V.A.C operation furnished.—Cat. No. SM-100. **\$3.95**



DYNAMOTOR

Power supply—inputs 6 or 12 V, output 500 VDC at 160 MA, mounted on box with circuit breakers, relays, interference filter and two 10 ft. cables. U. S. Govt. surplus. Cat. No. DM-101. **\$9.95**

Transmitter and Receiver

Has been widely used on the 144 MC band. Shipping wt. 100 lbs. U. S. Govt. surplus. Your price, less tubes and power transformer. Cat. No. RT-102. **\$14.95**

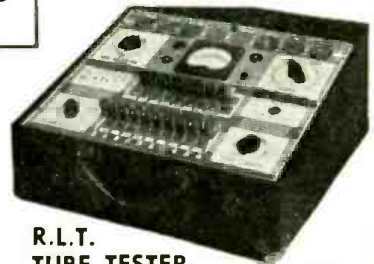

R.L.T. TUBE TESTER

Tests all tubes up to 117 V. • Tests shorts and leakages. • Tests individual sections. • Works on 90-125 V 60 cycle AC. • Comes in portable cabinet complete with all operating instructions with Bd. Cat. No. TT-100. **\$49.95**

Receiver and Transmitter SCR-522 USED In good cond. 100-156 MC receiver and transmitter complete with 18 tubes. Cat. No. RT-10 **\$29.95**

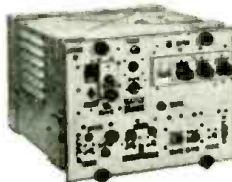

Hot Spot Specials

- Asst. resistors 1/2 watt fully insulated in popular ohmages per 100—Cat. No. R-5. **\$1.49**
- Asst. mica condensers per 100—Cat. No. C-12. **\$1.95**
- Water sockets 4-5-6-7 & 8 prong per 100—Cat. No. WF-4. **\$2.95**
- 12" Utah P. M. Speaker Alnico 1/3 with 676 output transformer—Cat. No. ST. **\$6.95**
- Asst. knobs push on wood & plastic per 100—Cat. No. KP-100. **\$1.95**
- 6J4—\$1.50, 6J6—95c.
- Johnson sockets #210-25W—Cat. No. JS-210. **49c**
- 75,000 ohm 200 W bleeder—Cat. No. B-73. **49c**
- 955-9004 tubes—Cat. No. T-99. **65c**
- Sockets for acorn tubes—Cat. No. AT-10. **19c**
- 8-8 MFD 350 WVDC, 20 MFD 150 WVDC, round can—Cat. No. RC-88. **69c**

Write for **FREE** Bulletin

HERSHEL RADIO CO.

5249 GRAND RIVER

DETROIT 8, MICHIGAN

20% DEPOSIT REQUIRED ON ALL C.O.D. ORDERS

Metropolitan

fills Mail Orders **Same day received!**

NEW TELEVISION RECEIVER KIT



Easy to assemble. No knowledge of television required. Complete easy-to-follow instruction sheet gives you all the knowledge you need. Finished Television Receiver has a picture that is clear and sharp... comparable to a moving picture.

All necessary components are included: nothing is required except a screw driver, cutting pliers and a soldering iron. Only the highest quality standard parts are used—the list price value of these parts alone is more than \$300. 110 volts, 60 cycles H.C.

FACTORY GUARANTEE—set guaranteed to operate satisfactorily if directions are followed exactly. Servicing of component parts and assembled parts will be performed by the factory at factory costs.

\$159⁵⁰



The New Model B-45 BATTERY OPERATED SIGNAL GENERATOR

for servicing AM, FM and Television Receivers

Self-modulated Signal Generator, providing a highly stable signal. Generates R.F. frequencies from 150 Kilocycles to 50 Megacycles (150 Kc. to 12.5 Mc. on Fundamentals and from 11 Mc. to 50 Mc. on Harmonics). R.F. is obtainable separately or modulated by the Audio Frequency. Direct reading—all calibrations are etched on the front panel. Complete with shielded test lead, self-contained batteries and instructions. **\$277⁵**

NET

We carry nearly 5,000 instruments in stock. All models listed below are available for immediate delivery.

PRECISION APPARATUS INSTRUMENTS

832S—31 Range AC-DC Multi-Range Tester	23.04
844P—34 Range AC-DC 6000 volts AC and DC VOLT-OHM MILLIAMMETER	32.20
856P—44 Range 20,000 ohms per volt AC-DC TESTER	49.94
864-AC-DC VOLT-OHM-DECIBEL-MILLIAMMETER with large 9" meter	59.60
912P—Dynamic Mutual Conductance Tube Tester	61.20
E-200—A.M.—F.M. and Television Signal Generator ..	64.15
EV-10P—6000 volts AC and DC Vacuum Tube Multi-Range-Meter	71.81
920P—Combination Dynamic Mutual Conductance Tube Tester, Battery Tester and 33 Range AC-DC Multi-Range Set Tester	84.22
954P—Combination Dynamic Mutual Conductance Tube Tester, Battery Tester and 37 Range Super-Sensitive AC-DC Multi-Range Set Tester. 20,000 ohms per volt DC	99.20

SUPREME INSTRUMENTS

543-Multi-Tester	18.95
589-Tube and Battery Tester with Rollchart	48.95
599-Tube and Set Tester with Rollchart	62.50
565-Vacuum Tube Voltmeter	63.50
576-Signal Generator	68.95
805-Combination Tube and Set Tester with Rollchart	89.50
546-Oscilloscope	89.75

McMURDO SILVER CO.

905—"Sparx" Dynamic Signal Tracer	39.90
904-Capacitance Resistance Bridge	49.90
900—"Vomax" Vacuum Tube Voltmeter	59.85
906-A.M.—F.M. Signal Generator	89.90

RADIO CITY PRODUCTS

447-Multi-Tester	17.95
448-Multitester	24.50
322-Dynoptimum Tube Tester	41.50
461-P-Sensitive Multi-Tester 2000 ohm per volt DC...	42.63
664-Electronic Multi-Tester	45.00
705-Signal Generator	49.50
315-Rollchart Tube Tester	59.50
802N-Combination Tube & Set Tester	59.50
668-V.T.V.O. Capacity Meter	73.01
805-Combination Tube & Set Tester	89.50
665A-V.T. "Billionaire" Insulation Tester plus V.T.V.M.	92.61

SUPERIOR INSTRUMENTS

CA-11—Signal Tracer	18.75
670—Super Meter	28.40
CA-12—Audible-Visual Signal Tracer	34.85
450—Tube Tester	39.50
650—Signal Generator	48.75
400—Electronic Multi-Tester	52.50
600—Combination Tube & Set Tester	62.50

SHALLCROSS MFG. COMPANY

Decade Resistance Boxes	13.50
Portable Galvanometers	27.50
630—Wheatstone Bridge	75.00
637—Kelvin Wheatstone Bridge	100.00
638-2-Kelvin Wheatstone Bridge	150.00

ALLEN B. DUMONT LABORATORIES

185A—Electronic Switch and Square Wave Generator ..	105.00
274—5" Oscilloscope	115.50

WATERMAN "Pocket" Oscilloscope	55.00
MONITOR Crystalliner Signal Generator	57.50
BLILEY, Crystal Controlled Signal Generator	69.50
WESTON-689-1F Ohmmeter, including leather carrying case, list price \$25.50.....only	14.85

The New Model 200 MUTUAL CONDUCTANCE TUBE TESTER



Here, FOR THE FIRST TIME, is a true, mutual conductance type tube tester with complete flexibility, and at a price no higher than that charged by other manufacturers for the ordinary emission type.

Note the unflinching accuracy with which it classifies the tubes under test, on the REJECT-GOOD scale. There is absolutely NO DANGER of BAD tubes reading "good" and GOOD tube reading "bad" on this E.M.C. Series 200 Tube Tester, as there is on all of the old-fashioned emission type testers.

3" Meter in sloping counter case	\$49⁸⁵
3" Meter in hand-rubbed carrying case	53.85
4½" Meter in sloping counter case	52.85
4½" Meter in hand-rubbed carrying case	56.85

Check These Features

1. Checks mutual conductance on a calibrated micromho scale, as well as on a REJECT-GOOD scale.
2. Checks five element tubes as pentodes.
3. Checks tubes for gas content.
4. Sufficient plate current to check both emission and mutual conductance.
5. Detects both shorted and open elements.
6. Complete switching flexibility allows all present and future tubes to be tested, regardless of location of elements on tube base.
7. Tests tubes for radio frequency and other noise.
8. Tests all tubes from .75 volts to 117 filament volts.
9. Tests all octal, octal, and miniature tubes.
10. Tests cold cathode, magic eye, and voltage regulator tubes, ballast resistors.
11. Instrument is protected with fuse, which is easily replaceable from front of panel.
12. Individual sockets for each tube-base type eliminates possible errors.
13. Check: individual sections of multiple-purpose tubes.
14. Attractive four-color panel with plenty of eye-appeal. Wrinkle background for durability.

TERMS: 25% Deposit, Balance C.O.D. Or Full Payment with Order.

SEND FOR FREE CATALOG!

Metropolitan

ELECTRONIC & INSTRUMENT CO.

Dept. C, 6 MURRAY STREET
NEW YORK 7, N. Y., U. S. A.

Cable Address: METRONICS
Phone: BARclay 7-5556

NEW! here it is
THE GREAT
Lafayette
RADIO CATALOG

FREE!

144 Value-Packed Pages

LAFAYETTE IS THE WORLD'S
 LARGEST RADIO SUPPLY HOUSE



NO more waiting! It's here—now—Lafayette's great 25th Anniversary Radio Catalog. And what a catalog it is. Packed with everything you can imagine in radio and electronic equipment. Such items as radio parts, complete sets, phono-radio combinations, build-it-yourself kits, amplifiers, microphones. Yes, and ham gear, public address systems, automatic record changers, tools, test instruments.

EVERYTHING HANDSOMELY ILLUSTRATED — Fully Described

All the tried-and-tested standard equipment is listed—also many items so recently developed they're shown here for the first time. Everything is in stock—economy priced—ready for super-speed delivery. There's nothing you could possibly want in radio and electronic equipment that you won't find in this amazing catalog. Your free copy will be mailed the day we receive the coupon below. Don't wait—mail it NOW!

HAMS!

We are stocked with Hammarlund, National, R.M.E. and Hallicrafter receivers. Everything you need in capacitors, resistors, tubes, meters, transformers, relays, switches, etc. Immediate Delivery!

EXPERIMENTERS!

No matter what you are building, all the parts you need are in the new Lafayette Catalog. Everything for building, experimenting, repair and maintenance in radio and electronics.

Lafayette Radio

RADIO WIRE TELEVISION, INC.
 100 Sixth Avenue, New York 13
 110 Federal Street, Boston 10
 24 Central Avenue, Newark 2

LAFAYETTE RADIO,
 Dept. JC-7, 100 Sixth Avenue, New York 13, N. Y.

Rush **FREE CATALOG** at once to:

Name.....
 Address.....
 City..... Zone..... State.....

MAIL COUPON BELOW . . . NOW!

Clip and paste on penny postcard

TECHNOTES

.... STROMBERG MODEL 1120

Intermittent distortion and loss of volume in Stromberg-Carlson Model 1120 series sets is often caused by voice-coil leads shorting to the speaker at the point where they pass through the hole in the frame. The hole should be lined with a rubber grommet. Spaghetti tubing is not satisfactory, as it will stiffen the leads and cause them to break at the ends.

DON TSUBOI,
 Tremonton, Utah

.... G.E. PORTABLE BL530

If this set operates only on the high-frequency end of the dial or erratically on the low end, replace the 1A7 regardless of the tube-tester indications.

OTTO WOOLLEY,
 Colorado Springs, Colo.

.... FADA MODEL 652

A general complaint about this set is that the dial sticks. Close observation will show that the dial pointer rubs the top of the cabinet. Remove the spacer from under the speaker. This lowers the assembly about 1/8 inch and clears up the trouble.

FLOYD D. GOFF,
 Black Mountain, N. C.

.... MOTOROLA 8-30

If a terrific hum develops in this model, check the filter condensers. If they are not at fault, the vibrator should be replaced. A universal vibrator cannot be used in this set, as it will often cause even more hum. A Mallory No. 859 (902M) is an exact replacement and can be used.

JOHN FINDARLE,
 Modesto, Calif.

.... ZENITH 85647

The push-buttons on this set do not always catch when pushed down for station setting. To remedy this condition, put a drop of light lubricating oil on each end of the small horizontal sliding bar which holds the vertical catches. After oiling, continue to push the buttons until smooth operation is obtained.

MANUEL E. SILVIA, JR.,
 Monterey, Calif.

RESCUE BY HAM RADIO

A radio amateur in Ohio was able to rescue 300 motorists trapped in a blizzard in New Mexico last November. The amateur, Paul L. Hughes of Canton, Ohio, picked up an urgent message from Dale L. Hauch, another amateur from Battle Creek, Michigan, who had a mobile transmitter in his car.

Relaying the message: "Trapped in terrific snowstorm 65 miles west of Albuquerque. Can you get help?" to an Albuquerque ham, Foy A. Roger, the Ohio amateur was informed that a rescue party was under way just twenty minutes after the call for help had been received.

JOBBER AND DEALERS DIRECTORY

FOR READERS OF RADIO-CRAFT

This list of Radio Jobbers and Dealers has been compiled as a service to RADIO-CRAFT readers. The magazine is sold by the stores listed below where they are displayed on counters and shelves for your convenience. At these stores you will also be able to buy standard parts, sets, and every other product of the radio and electronic industry.

ALABAMA

Decatur
Radio & Tel. Sup. Co.
717 Bank St.

Dothan
Hand Wholesale Radio
& Refrig.
707 S. Gates St.

Tuscaloosa
Allen & Jomison Co.

ARIZONA

Phoenix
Radio Specialties
& Appl.
401 W. Jackson

ARKANSAS

Fort Smith
Packard Radio Co.
205 Garrison Ave.

Wise Radio Supply
1001 Towson

LeFlore
Lavender Radio Sup. Co.
Ash at 4th Sts.

CALIFORNIA

Bakersfield
Bakersfield Radio Sup.
2808 Chester Ave.

Fresno
Jack C. Arbuckle
1427 Broadway

Hollywood
Hollywood Radio Sup. Inc.
5521 Hollywood Blvd.

Yale Radio Electric Co.
6616 Sunset Blvd.

Long Beach
Fred S. Dean Co.
968 American Ave.

Scott Radio Supply
226 Alamilos Ave.

Los Angeles
General News Agency
326 W. 5th St.

Papel Bros.
2639 E. 4th St.

Radio Tel. Sup. Co.
149 12th St.

Sacramento
E. M. Kemp Co.
1115 R. St.

Sacramento Elec. Sup. Co.
711 Capitol Ave.

San Bernardino
George D. Bagley Co.
1216 D St.

San Diego
Harold W. Burt
Radio-Electronic
4162-64 Park Blvd.

Electronic Equip. Distr.
1228 2nd Ave.

Western Radio & Elec. Co.
1415 India St.

San Francisco
Associated Radio Dist.
1251 Folsom St.

San Francisco Radio
& Supply Co.
1284 Market St.

San Jose
Frank Quement Whole-
sale Radio
156 W. San Fernando St.

Santa Ana
Radio & Tel. Equip. Co.
207 Oak St.

COLORADO

Denver
McGee Radio & Elect. Co.
4330 Broadway

Radio Products Sales Co.
1237 16th St.

Western Electronic
Lab. Co.
913 18th St.

Grand Junction
Radio & Electronics
Supply Co.
418, South 7th St.

CONNECTICUT

Bridgewater
Coastal Radio Service Co.
1559 Stratford Ave.

R. C. Seel & Co., Inc.
84 Elm St.

L. N. Waldhaus
1132 Norman St.

Hartford
R. G. Seeli & Co.
317 Asylum St.

New Britain
United Radio Supply
53 E. Main St.

New Haven
Congress Radio
& Battery Co.
207 Congress Ave.

Rockville
Alfred C. Denson
38 Park Place

DELAWARE

Wilmington
Radio Electric Service Co.
4th and Tatalnol Sts.

DISTRICT OF COLUMBIA

Washington
Capitol Radio
Wholesalers
2120 14 St. N.W.

Intercommunications Co.
2027 Nichols Ave. S.E.

Kenyon Radio Supply Co.
2214 14th St. N.W.

Sun Radio
938 N.W. F St.

FLORIDA

Jacksonville
Radio Parts Co.
712 Main St.

Thurrow Distr. Inc.
806 Main St.

Miami
Thurrow Distr. Inc.
420 S.W. 8th Ave.

Orlando
Thurrow Distr. Inc.
131 South Court St.

St. Petersburg
Welch Radio Supply
408 9th St. So.

Tallahassee
Thurrow Distr. Inc.
213 E. Tennessee St.

Tampa
Thurrow Distr. Inc.
115-117 St. Franklin St.

West Palm Beach
Thurrow Distr. Inc.
209 No. Olive St.

GEORGIA

Augusta
Prestwood Electronics Co.
727-29 Reynolds St.

Columbia
Radio Sales & Svce. Co.
1326 First Ave.

Macon
Guy White Radio
654 Mulberry St.

ILLINOIS

Benton
Lampley Radio Co.
802 N. McLeansboro St.

Danville
Allen Electric Co. Radio
Supply
109 N. Hazel St.

Decatur
York Radio Distr. Co.
801-805 N. Broadway St.

Chicago
Allied Radio Corp.
833 W. Jackson Blvd.

American Parts Inc.
610 W. Randolph St.

Concord Radio Corp.
901 W. Jackson Blvd.

Electronic Distributors
620 W. Randolph St.

Mr. Martin C. Flynn
American Telev. Inst.
433 E. Erie St.

Lake Radio Sales Co.
615 W. Randolph St.

Radio Shack
630 W. Randolph St.

Radolock Co.
601 W. Randolph St.

Schuh Radio Parts
1253 Loyola Ave.

East Moline
C. L. Swanson Radio
Laboratory
933 15th Ave.

Goreville
Century Supply Co.
Main St.

Rockford
Mid-West Associates
306 Walnut St.

Springfield
Harold Bruce
303 E. Monroe

Wilson Supply Co.
108 W. Jefferson St.

W. Frankfort
Radio Hospital
1107 E. Main St.

INDIANA

Anderson
Seybert's Radio Supply
19 E. 12th St.

Evansville
Castrup's Radio Sup.
1014 W. Franklin St.

Montoux Auto & Machine Co.
517 Louest St.

Gary
Cosmopolitan Radio Co.
524 Washington St.

Hammond
Stanton Radio Supply
521 State St.

Indianapolis
Rodefeld Co.
614 N. Capitol

South Bend
Commercial Sound
& Radio Co.
534 E. Colfax Ave.

Terre Haute
Terre Haute Radio
501 Ohio St.

IOWA

Council Bluffs
World Radio Labs

Des Moines
G. W. Onthank Co.
11th & Cherry

Dubuque
Bee Distributing Co.
498 N. Grandview

Fort Dodge
Ken-Els Radio Sup. Co.
111 So. 12th St.

Sioux City
Dukes Radio Co.
116 W. 4th St.

Power City Radio Co.
513 7th St.

Sloux City Radio
& Appliance Co.
313 Fifth Street

Waterloo
Ray-Mae Radio Supply
324 W. 4th St.

KANSAS

Pittsburgh
Pittsburgh Radio Sup. Co.
103 N. Broadway

Topoka
Radio Electric Supply
516 Quinley St.

Wichita
Interstate Distr. Inc.
1236 E. Douglas

Radio Supply Inc.
1125-27 E. Douglas

KENTUCKY

Lexington
Kentucky Radio Supply Co.
519 Georgetown St.

Louisville
Peerless Electronic
Equip. Co.
912-914 So. Second St.

Newport
Apex Distributing Co.
506 York St.

Prestonsburg
General Supply Co.
North Broadway

LOUISIANA

Lafayette
Radio-Electronic Sup.
1419-21 Cameron St.

Monroe
Hale & McNeil
301 Pine St.

New Orleans
Wm. B. Allen Supply Co.
916-918 W. Calborne Ave.

Radio Parts Inc.
807 Howard Ave.

Shreveport
Koelemay Sales Co.
327 Market

MAINE

Bangor
Radio Service Lab.
45 Haymarket Sq.

Portland
Maine Electronic
Supply Corp.
13 Deer St.

Radio Service Lab.
45 A Free St.

MARYLAND

Baltimore
Henry D. Berman Co. Inc.
12 E. Lombard St.

D. & H. Dist. Co.
31 E. Lee St.

Royal Radio
941 Penna. Ave.

Wholesale Radio Parts
Co. Inc.
311 W. Baltimore St.

Cumberland
Cumberland Radio
Wholesalers
143 N. Centre St.

MASSACHUSETTS

Boston
Hub Cycle & Radio Co. Inc.
596 Commonwealth Ave.

Sager Electrical Sup. Co.
201 Congress St.

Lawrence
Haly & Young of Mass.
Inc.
339 Essex St.

Melrose
Melrose Sales Co.
407 Franklin St.

New Bedford
C. E. Beckman Co.
Commercial St.

Springfield
Springfield Radio Co. Inc.
405 Dwight St.

Springfield Sound Co.
147 Dwight St.

Worcester
Radio Electronic Sales Co.
46 Chandler St.

Radio Maintenance Supply
19-25 Central St.

MICHIGAN

Ann Arbor
Purchase Radio &
Camera Shop
805 Church St.

Berkley
The J. M. Marel Co.
1949 Woodward Ave.

Detroit
M. N. Duffy & Co.
2040 Grand River Ave.

Electronics Inst. Inc.
21 Henry at Woodward

Radio Center
5834 W. Warren

Hershel Radio
5429 Grand River Ave.

Radio Electronic Supply
1112 Warren West

Radio Specialties
456 Charlotte St.

Radio Supply Co.
6724 Michigan Ave.

Radio Supply & Eng. Co.
129 Selden Ave.

Flint
Radio Tube Mds Co.
508 Clifford

Sheldon Radio & Appliance
2914 N. Saginaw St.

Jackson
Fulton Radio Supply Co.
707 S. Blackstone St.

Lansing
Electric Products Sales Co.
427 E. Michigan Ave.

Muskegon
Industrial Electric
Supply
1839 Puck St.

Saginaw
Orem Distributing Co.
801 E. Genesee Ave.

Radio Parts Co.
234 S. Second St.

MINNESOTA

Duluth
Lew Bonn Co.
228 E. Superior St.

Northwest Radio
109 E. First St.

Minneapolis
Lew Bonn Co.
1211 LaSalle Ave. So.

Northern Radio Lab.
3927 East Lake St.

Ron's Radio Supply
4001 Bryant Ave., So.

MISSISSIPPI

Jackson
Cabell Electric Co.
Meridian
Radio Supply Co.

MISSOURI

Cape Girardeau
Suedatum Electronic
Supply Co.
902 S. Sprigg St.

St. Joseph
Ame Radio Supply
110 N. 9th St.

St. Louis
Nappier Radio Co.
3117 Washington

Springfield
Harry Reed Radio &
Supply Co.
833-37. Boonville Ave.

MONTANA

Butte
Geo. Steele & Co.
126 W. Broadway

Great Falls
Geo. Lindgren Co.
109 Central Ave.

NEBRASKA

Lincoln
Hicks Radio Co.
1422 "O" St.

Omaha
Aico Radio Inc.
411 Cumling St.

All-State Distr. Co.
2857 Farnum St.

H. O. Noll Co.
226 Harney St.

Omaha Appliance Co.
& St. Mary's
Radio Equipment Co.
2824-22 Farnum St.

NEW HAMPSHIRE

Concord
Evans Radio
18 N. Main

NEW JERSEY

Bridgeton
Joe a. Radio Shop
67-19 S. Pearl

Camden
Radio Electric Service Co.
513 Cooper St.

Hackensack
Trade Radio Servler Co.
101 1/2 Morris St.

Newark
Radio Wire Telev. Inc.
24 Central Ave.

Variety Electric Co.
60 Broad St.

Philipsburg
Carl B. Williams Co.
151 South Main St.

Red Bank
Bradleys Radio Service
Newman Springs Rd.

See Other Side For Additional Listings

JOBBER AND DEALERS DIRECTORY

FOR READERS OF RADIO-CRAFT

This list of Radio Jobbers and Dealers has been compiled as a service to RADIO-CRAFT readers. The magazine is sold by the stores listed below where they are displayed on counters and shelves for your convenience. At these stores you will also be able to buy standard parts, sets, and every other product of the radio and electronic industry.

NEW JERSEY--Cont'd

Trenton
Allen & Hurley
25 South Warren St.
Carl B. Williams
25 S. Warren St.

NEW YORK

Albany
E. E. Taylor Co.
465 Central Ave.

Binghamton
Broome Dist. Co.
221 Washington St.

Brooklyn
Electronic Equipment
Co. Inc.
1460 Bushwick Ave.
Green Radio Distr.
482 Sutter Ave.
Hornbeam Distributing Co.
1639 Bedford Ave.

Buffalo
Buffalo Radio Supply
219 E. Genesee St.
Scheller Radio Co.
269 Oak St.
Standard Electronics
Dist. Co. Inc.
1497-1501 Main St.

Cortland
C. A. Winchell
37 Central Ave.

Groton-Or-Hudson
WRO Radio Laboratory
6 Hamilton Ave.

Elmira
Fred C. Harrison Co.
108 W. Church St.

Jamaica
Harrison Radio Corp.
172-31 Hillside Ave.
Norman Radio Dist.
94-29 Merrick Rd.
Peerless Radio Dist. Co.
92-32 Merrick Rd.

Jamestown
Johnson Radio &
Electronic Equip.
48-50 Harrison Ave.

Mount Vernon
Davis Radio Dist. Co.
66-70 E. 3rd St.

New York City
Adson Radio
221 Fulton St.
Arrow Radio
82 Cortland St.
Beam Radio
165 Nassau Ave.
Blair Radio
64 Day St.
Eagle Radio
84 Cortland St.
Federated Purchaser Inc.
80 Park Place
Grand Central Radio
124 E. 44th St.
Harrison Radio Corp.
12 W. Broadway
Harvey Radio Co.
105 W. 43rd St.
Highbridge Radio
Television & Appl.
340 Canal St.
B. Lar
210 Greenwich
Niagara Radio Supply Corp.
160 Greenwich St.
Newark Electric Co.
224 Fulton St.
Radio Wire Telev. Inc.
100 Sixth Ave.
Sun Radio
122 Duane
Wico Radio Dist.
383 E. 138th St.

Olean
Wanamaker & Redstone
413 Third Ave.
Poughkeepsie
Chief Electronics
104 Main St.
Rochester
Hunter Electronics
233 East Ave.
Masline Radio &
Electric Equip.
192-196 Clinton Ave. N.

Rochester Radio Sup. Co.
114-118 St. Paul St.

Syracuse
Broome Dist. Co.
912 Erie Blvd. E.
Stewart W. Smith Inc.
325 E. Water St.
Syracuse Radio Supply
238-40 W. Willow St.

White Plains
Westchester Electronic
Sup. Co.
333 Mamaroneck Ave.

NORTH CAROLINA

Charlotte
Henry V. Dick & Co. Inc.
311 E. 5th St.

Goldboro
Signal Radio Supply
124 S. James St.

Raleigh
Supreme Radio Suppliers
130 W. Hargett St.

Winston-Salem
Daiton-Hego Radio Sup. Co.
340 Brookstown Ave.

NORTH DAKOTA

Fargo
Radio Equipment Co.
624 2nd Ave. N.

OHIO

Ashtabula
Morrison's Radio Supply
331 Centre St.

Akron
Brighton Sporting
Goods Corp.
110 E. Market St.

Cincinnati
Chambers Radio Supply
1104 Broadway
Herrlinger Dist. Co.
15th & Vine Sts.
Holub & Hogg
500 Reading Rd.

Cleveland
Northern Ohio Labs.
2073 W. 85th St.
Radio Surplus Co.
648 Prospect Ave.
Strano, Carlisle &
Hammond Co.
2801 St. Clair Ave.

Winterradio Inc.
1468 W. 25th St.

Columbus
Electronic Supply Corp.
219 N. 4th St.
Whitehead Radio Co.
120 East Long St.

Warren
Radio Specialties
136 S. Pine St.

Dayton
Standard Radio &
Elect. Prod.
135 E. 2nd St.
E. Liverpool
Hausfeld Radio Supply
414 E. 5th St.

Kent
Kladag Radio Labs.
105 W. Erie St.

Marion
Bell Radio Supply
527 N. Main St.

Steuenville
D & R Radio Supply
156 S. 3rd St.
Hausfeld Radio Supply
230 N. 4th St.

Toledo
Lifetime Sound Equip. Co.
911-913 Jefferson

OKLAHOMA

Lawton
Reynolds Radio Supply
909 1/2 C Ave.

Oklahoma City
Radio Supply Inc.
724 N. Hudson, Box 597

OREGON

Portland
Appliance Wholesalers
of Oregon
600 N.W. 14th Ave.
Harper-Meggee
1506 N.W. Irving

PENNSYLVANIA

Allentown
Radio Electric Service Co.
1042 Hamilton St.

Altoona
Hollenback's Radio Supply
2221 8th Ave.
Kennedy Radio Supply
1500 Fifth Ave.

Beaver Falls
Reliable Motor Parts Co.
1700 7th Ave.

Easton
Radio Electric Service Co.
916 Northampton St.

Erie
Jordan Electronic Co.
201 W. 4th St.
Warren Radio
12 & State Sts.

Harrisburg
D. & H. Distributing
Co. Inc.
311 S. Cameron St.

Lancaster
Eshelman Supply Co.
110 N. Water St.

Philadelphia
A. G. Radio Parts Co.
3515 N. 17th St.

Almo Radio
509 Arch St.
Flanagan Radio Corp.
N.E. Cor. 7th & Chestnut
M. & H. Sporting Goods Co.
512 Market St.

Radio Electric Service Co.
7th & Arch Sts.
3145 North Broad St.
5133 Market St.

Warner Radio Co.
631 Market St.

Scranton
Broome Dist. Co.
26 Lackawanna Ave.
Fred P. Purcell
553 Wyoming Ave.

Sharon
Heides Bros. Inc.
73 Central Way

York
J.R.S. Distributors
646 W. Market St.

RHODE ISLAND

Providence
William Dandreta & Co.
Regent Ave.
Powell Radio Supply
49 Atwells Ave.

SOUTH CAROLINA

Charleston
Radio Laboratories
215 King St.

Greenville
Arthur Rexor
209 W. Washington

SOUTH DAKOTA

Sioux Falls
Power City Radio Co.
209 So. First Ave.

TENNESSEE

Chattanooga
Curlie Radio Supply
875 Cherry St.

Kingsport
Radio Electric Sup. Co.
210 Cherokee St.

Knoxville
Bomar Appliance Co. Inc.
520 Western Ave.

Memphis
Bluff City Dist. Co.
905 Union Ave.
Radio & Electronic
Supply Co.
1002 Jackson Ave.
Shobe Inc.
1117 Union Ave.

Nashville
Frost Electric Inc.
1922 West End Ave.

TEXAS

Amarillo
R & R Electronic Co.
412 W. 10th St.

**Tom Thomas Sound Sales
& Service**
410 S. Jackson

Beaumont
R. C. & L. F. Hall Co.
961 Pearl St.

Dallas
All-State Dist. Co.
2405-07 Ross Ave.
R. C. & L. F. Hall Inc.
2123 Cedar Springs
Southwest Radio Sup.
1820 N. Harwood

Fort Worth
Fl. Worth Radio Sup. Co.
1201 Commerce
The Electronic Equip. Co.
301 E. 5th St.

Galveston
R. C. & L. F. Hall Inc.
1803 Tremont

Houston
R. C. & L. F. Hall Inc.
1015 Caroline St.
R. C. & L. F. Hall Inc.
1306 Clay St.
Sterling Radio Prod. Co.
1602 McKinney

Laredo
Radio & Electronics
Supply Co.
1219 Lincoln St.

Lubbock
R & R Supply Co. Inc.
706 Main St.

Port Arthur
Lapham Radio Co.
309 1/2 Proctor St.

San Antonio
Mission Radio Inc.
814 So. Presa St.
Tom Hopkins Radio
324 Nacogdoches St.

Stark Radio Supply Co.
131 S. 6th St.

**South Texas Radio
Supply Co.**
445 E. Commerce

Tyler
Radio Service Supply Co.
111 University Place

Waco
The Hargis Co. Inc.
1305 Austin Ave.

UTAH

Ogden
Ballard & Carter Co.
203 24th St.

Salt Lake City
O Laughlin's Radio
Supply Co.
113 E. Broadway
Radio Supply Co.
45 E. 4 South

VIRGINIA

Norfolk
Ashman Distributing Co.
807 Granby St.
Radio Parts Dist. Co.
128 W. Olney Rd.
Radio Supply Co.
711 Granby St.

Richmond
Johnston Gasser Co.
1402 E. Main St.

Roanoke
H. C. Baker Sales Co.
19 W. Franklin Rd.
Leonard Electronic
Supply Co.
106 Second St. S.W.

Salem
Richie Radio Supply
305 E. Main St.

Staunton
Southern Electric Corp.
14 E. Johnson St.

WASHINGTON

Bellingham
Waikus Supply Co.
110 Grand Ave.

Seattle
Harper-Meggee
960 Republican St.
Western Electronic
Supply Co.
2609 First Ave.

Spokane
Columbia Electric
& Mfg. Co.
P.O. Box 1441 S.
123 Wall St.

Tacoma
C. & G. Radio Sup. Co.
714 St. Helens Ave.
A. T. Stewart Co.
743 Broadway
Wible Radio Supply
909 Tacoma Ave.

WEST VIRGINIA

Clarksburg
Trenton Radio Co.
791-93 W. Pike St.

East Charleston
Hicks Radio Supply
10 Virginia St.

Parkersburg
John A. Cox Radio
Supplies
554 7th St.

Wheeling
General Distributors
21 10th St.

WISCONSIN

Appleton
Valley Radio Dist.
518 N. Appleton St.

Chippewa Falls
Bushland Radio Spec.

Green Bay
Nesto Electronic Dist.
312 N. Chestnut
Northern Electrical Dist.
708 S. Broadway

Hudson
J. H. Larson Co.
109 Walnut St.

LaCrosse
Stark Radio Supply Co.
131 S. 6th St.

Madison
Satterfield Radio
Supply Inc.
326 W. Gorham St.

Manitowac
Harris' Radio Company
115 No. 10th St.

Milwaukee
Acme Radio Supply Corp.
510 N. State St.
Acme Radio Supply
310 W. State St.
Central Radio Parts Co.
1723 West Fond du Lac Ave.
Electro-Philance Dist. Inc.
2458 W. Lisbon Ave.
Electronic Supply Corp.
436 W. State St.
Juneau Radio Supply Co.
137 W. Juneau Ave.
Taylor Electric Co.
112 N. Broadway

Racine
Standard Radio Parts Co.
1244 State St.

WYOMING

Casper
Golden Power Oil &
Supply Co.
260 S. Center

Cheyenne
Houge Radio & Supply Co.
2008 Carey Ave.

CANADA

Radio Supply Co. Ltd.
Grd. Floor McLeod Bldg.
Edmonton, Alberta.

Western Radio Supply Co.
328-330 King St. E.
Hamilton, Ontario

Delroy Sales Ltd.
203 Rideau St.
Ottawa, Ont.

Electronic Supply Co.
(Ottawa Ltd.)
244 Slater St.
Ottawa, Ont.

Electro-Voice Sound
Systems
141 Dundas St. West
Toronto, Ont.

Hygrade Radio Ltd.
673 Homer St.
Vancouver, B.C.

DEALERS: If you are not receiving RADIO-CRAFT, please ask for our Special Consignment Proposition.

TRANSATLANTIC NEWS

(Continued from page 41)

multipath transmissions due to reflections by buildings, mountains, and so on. Despite all that has been said of other systems, practical trials and careful analysis of data have shown that FM stands unrivaled in the field.

Radio and Air Safety

We, like everyone else, have been so worried over the appalling number of airplane disasters all over the world in recent months that the decision of P.I.C.A.O. to adopt standardized systems of navigation and landing aids at all international airports has come as a relief. As the SCS-51 and Loran have been judged the best means of ensuring this, we welcome their coming. At the same time we should like to see the adoption of more specialized aids to the planes engaged in comparatively short hops of 200 to 500 miles, such as we have in England and in many parts of Europe. We're conceited enough to believe that our O.R.B. (Omni-directional Radio Beacon) and P.O.P.I. (Post Office Position Indicator) are the best available aids for jobs of that kind. The latter does not show you the way to the post office! It was developed by the engineers of the British General Post Office. Both are responder radar beacons which identify themselves and give his bearing to any pilot whose apparatus "interrogates" them. There is no doubt that chains of such beacons are needed on all flying routes. Warning radio "lighthouses" are also needed to give the pilot notice that he is approaching steep rises in the ground surface.

Radar-Radio Ship

One of the most remarkable ships now afloat is the British Navy's *H.M.S. Boxer*. To all intents and purposes she is nothing more nor less than a floating radar and radio center. Designed to control the fighter planes over troops making a landing, she incorporates six high-power major radar equipments, besides several smaller ones, IFF for both ships and aircraft, radio beacons of various kinds, and radio telegraph and telephone equipment for all bands.

Four masts and a large part of her deck space are required to carry the multiplicity of antennas—"cheeses," "mattresses," "Yagis," simple dipoles, folded dipoles, stacks of dipoles, and just plain honest-to-goodness antennas—that bewilder the eye when you first catch sight of her. The *Boxer* has no room for anything much in the way of armament: all that she carries is a few antiaircraft guns. But she can control and guide home a mass of fighters, besides keeping a lookout for hostile aircraft, surface ships, and submarines; and at the same time conducting two-way communications simultaneously with army and navy headquarters and maybe a dozen other friendly ships. She carries, besides navigating crew, 30 officers and 250 men, all radio and radar specialists.

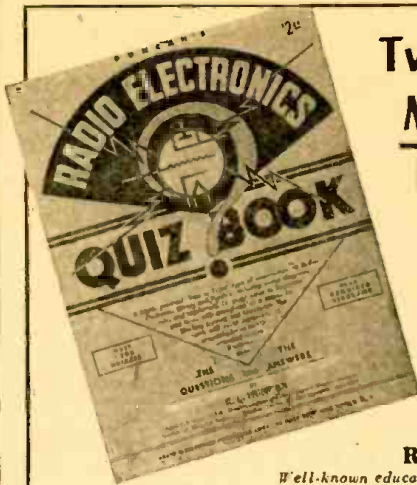

Two New MUST Books



By

R. L. Duncan

Well-known educator and Radio-Electronics author,
Colonel, Sig. Corps Res.; Member, Amer. Inst. of E.E.,
Inst. of Radio Engineers, Veteran Wireless Operators' Assn.

This Quiz Book is of inestimable value to students, trainees and those with experience as a means for checking knowledge and training. It is tops as a pre-examiner for radio license examinations. A highly practical "True or False" type of question and answer treatise containing more than 1200 quizzes, plus the required circuit diagrams. This book points the way . . . acclaimed as a superior means for determining the scope of your Radio-Electronics "know how".

This Dictionary of Radio-Television-Radar is prepared especially for technicians, students, mechanics, operators, experimenters, trainees, amateurs and others associated with the radio-electronics industry . . . arranged for ready reference and practical application in one streamlined up-to-date book containing Formulas, Symbols, Conversion Tables and various essential data, as well as definitions of terms and technical expressions encountered in the broad field of Radio-Electronics.

You Need These Books . . . Order Them NOW!

Only \$2.00 for the Quiz Book and \$1.50 for the Dictionary at your dealer, or if he cannot supply you, order direct. Remit by money order or check—do not send cash.

RADIO-ELECTRONICS PUBLISHING CORP., DEPT. RC 3, 15 PARK ROW, NEW YORK 7, N.Y.

Nationally Known AUTOMOBILE ANTENNAS

Side Cowl—3 Section 66"

Sturdy Rust Proof

\$4.75 LIST \$2.13 NET

Deluxe Side Cowl—4 Section 100"

Sturdy Rust Proof

\$7.45 LIST \$3.36 NET

Top Cowl (Fender Mount)

3 Section 56"

\$5.95 LIST \$2.58 NET

Universal Cowl or Fender

Mount 3 Section 68"

\$5.95 LIST \$2.58 NET

All are complete, ready for installation
All are chrome plated

VIBRATORS

Standard 4 Prong \$1.40 each

10 FOR \$12.50

CONDENSERS

.005 mfd. 1200 V DC Buffer Condensers

19 CENTS EACH - 10 FOR \$1.50

100 FOR \$12.50 - 1000 FOR \$100.00

STANDARD DISTRIBUTOR AND SPARK PLUG SUPPRESSORS

17 Cents Each - 10 for \$1.50 - 100 for \$12.50

STANDARD VIBRATOR TRANSFORMERS 98 Cents Each

CROWE REMOTE CONTROL AUTO HEADS

For All Makes, All Years \$3.82 each

Tone Controls 1.71 "

Volume Controls .73 "

SPECIAL - SPECIAL - SPECIAL

St. Clair Vacuum Tube Voltmeter
6 DC Voltmeter Ranges
6 AC Voltmeter Ranges
Ohmmeter Range from 0.1 Ohms to 1000 Megohms
Accuracy 2% Plus or Minus
Formerly \$52.50 - Now \$42.50

A COMPLETE LINE OF TUBES ARE NOW AVAILABLE

Write for our latest Catalogue

RADIO PARTS COMPANY

612 W. Randolph, Dept. "C"

Chicago 6, Illinois

ANOTHER RESCO SCOOP

Brand New! **SAVE 77%** OFF LIST PRICE

ARMY SURPLUS ALIGNMENT TOOLS

Take advantage of guaranteed 70% to 77% discounts from established list prices! Each made to rigid Army specifications. Guaranteed perfect or money back! Write for quantity prices. Include postage with cash orders.

5-IN-1 NEUTRALIZING AND COMPENSATING TOOL ICA NO. 1022

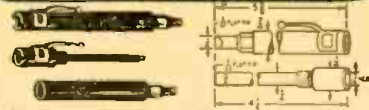

Made of Fenolite—fully insulated. 5/16" and 1/4" nut wrench, key slot. Neutralizing screw driver and heavy duty all metal screw driver included.

List Price \$1.50 Resco's Price **45c**

ALIGNMENT TOOL ICA NO. 1015



Narrow shaft neutralizing tools made of bone fibre—screw nib inserted on one end, and narrow screw driver on other end. Used on late models R.C.A. receivers for aligning trimmers, push buttons, etc.

List Price 95c Resco's Price **30c**

INSULATED NEUTRALIZING WRENCH HEXED — FULL LENGTH ICA NO. 980

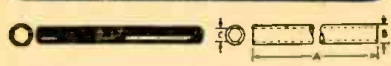

Made of sturdy black "Fenolite", hexed all the way through. Entire length of the inside of the tube is broached so that when one part wears out or breaks, just saw off part and continue using the neutralizing wrench.

NO.	A	B	C
980	5"	3/4"	1/4"

List Price 35c Resco's Price **8c**

ALIGNMENT TOOL SIMILAR TO GENERAL CEMENT NO. 5016



Made of bone fibre, combination tool that can be used for most purposes. Consists of screw driver with metal nib, 5/16" hex wrench, 1/4" hex side wrench and 1/4" hex end wrench slotted.

List Price \$1.35 Resco's Price **40c**

ALIGNMENT SCREW DRIVER GENERAL CEMENT NO. 5000

Low inductance metal tip screw driver made of Genflex material — strong — durable, completely insulated, 1/4" diameter x 6" long.

List Price 40c Resco's Price **12c**

BELDEN MIKE CABLE

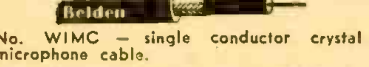

No. WIMC — single conductor crystal microphone cable.

Ft.	100 Ft.	1000 Ft.
5c	\$4.50	\$40

SPST TOGGLE SWITCH

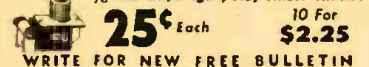

3/8" shank, single pole; single throw. 10 For **\$2.25** 25c Each

WRITE FOR NEW FREE BULLETIN

Radio Electric SERVICE CO. OF PENNA., INC.

7TH AND ARCH STREETS, PHILA. 6, PENNA. Branches: 5133 Market St. and 3145 N. Broad St. in Phila. Also in Wilmington, Del., Easton, Pa., Allentown, Pa., Camden, N. J.

THE 'SCOPE—A REPAIR TOOL

(Continued from page 28)

as was indicated in the first part of this article.

I.F. Section

The next step in the order of testing is to answer the lady who innocently tells us, "My husband noticed that those little screws on top of the cans were loose and he tightened them up good, but the set still plays terrible!" So, on to the i.f. section. The quick check point for this portion, (test No. 14), consists of an observation as it appears on the 'scope of the audio output of the demodulated i.f. signal (455 kc), connected across the detector output at the diode load resistor (high end of the 500,000-ohm volume control).

The r.f. signal from the signal generator is tuned to 455 kc, modulated at 400 cycles, and fed into the grid of the 12SA7 converter tube at the stator connection of the antenna tuning condenser. With the radio's volume control in its normal operating position, the signal from the generator is attenuated to the lowest value that will give a useful reading. A check on alignment can be made readily at this point by adjusting the i.f. trimmers with an insulated alignment screwdriver and observing the peaks of the audio signal for maximum output. If there is any reason to suspect an individual i.f. stage (for misalignment, faulty a.v.c. operation, or the like), we follow the injected signal backward step by step through each portion, (Tests No. 10, 11, 12 and 13), successively investigating the second i.f. transformer, the i.f. amplifier tube, the first i.f. transformer, the con-

The receiver oscillator test is the quick check point, test No. 15. The 'scope is still connected to show the demodulated set output (at the voice coil, for convenience in trimming), while the signal generator frequency is increased to 1425 kc, modulated at 400 cycles, to simulate a broadcast station in the upper frequencies. Operation of the oscillator circuit can now be checked while adjusting the oscillator trimmer with an insulated alignment screwdriver for maximum output. If the oscillator circuit is suspected, a rapid check on its operation may be obtained by measuring the negative d.c. voltage at the oscillator grid (pin No. 5 of the 12SA7) with a high-resistance or vacuum-tube voltmeter. This voltage should remain fairly constant (within at least ten percent) while the receiver tuning dial is rotated through the entire frequency range of the set. (If no oscillator voltage at all is obtained, the signal generator may be substituted for the oscillator by injecting an r.f. signal at the oscillator grid and tuning the generator to a frequency 455 kc above that of the desired station.)

Antenna Section

The final test (test No. 16) is the quick check point for the antenna circuit that should provide a tuned input to the converter tube. To obtain this check on over-all receiver performance with the least possible interaction with other circuits, it is best to couple the signal from the generator by means of a pickup loop of one or two turns of wire with the ends connected to the signal generator terminals. This loop when held near and roughly parallel to the receiver loop, should provide ample inductive coupling for satisfactory receiver operation. The antenna tuning trimmer can now be adjusted for maximum output, first at 1425 kc and then at about 600 kc. A final retrimming of both oscillator and antenna trimmers completes the alignment.

Optional Tests

If available, a signal generator with a frequency-swept (wobulated) output will provide a very rapid and effective check on the resonance (or band-width) characteristics of the i.f. circuit. This check is especially valuable for high-fidelity receivers. Such a signal has a center frequency equal to the intermediate frequency of the set (455 kc) and is swept above and below this frequency by the "wobulator" at a periodic rate (such as 30 cycles), which can be synchronized with the EXTERNAL SYNC binding post of the 'scope. (Such signals are available from special Supreme and Hickok signal generators). The expected result, as shown in test No. 17, will appear as a tuning curve showing i.f. response starting with practically zero response below

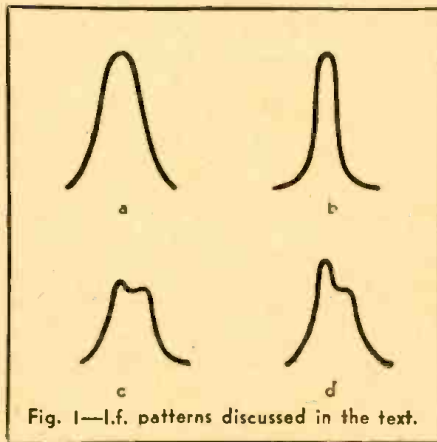

Fig. 1—I.f. patterns discussed in the text.

verter tube 12SA7, and then the a.v.c. action. [For a measure of the a.v.c. action in d.c. volts, a high-resistance (20,000-ohms-per-volt or vacuum-tube) voltmeter may be connected between the high end of the diode load resistor and the chassis. The 'scope is indicating the demodulated audio output.]

An even faster and better check of the i.f. system may be obtained by a visual pattern of i.f. response through the use of a frequency-swept ("wobulated") signal. This method is discussed in a later paragraph and illustrated in Fig. 1.

(Continued on page 68)

WORKING ON 50 AND 420 Mc

(Continued from page 36)

The Special Capacitor

The stators of the SEU-15 and two of the rotors are removed and discarded and the pigtail cut off. The remaining 4 rotors and spacers are rearranged as shown in Fig. 4-a. Should an SEU-15 be hard to get, a substitute can be made up as indicated in Fig. 4-b. For this reason dimensions in Figs. 4 and 5 are approximated to allow for minor adjustments. The oscillator plate lines now act as stators and the rotor shaft and spacers should clear the plate lines by about 1/8-inch. At maximum capacitance the flat portions of the rotors are flush with the plate lines. Spacing between them should be approximately 0.020-inch. Stops should be provided so that the rotor shaft will pass through an angle of approximately 120 degrees. The legs of the homemade condenser may be either lucite or bakelite and the stops may be 3/8-inch brass machine screws tapped into the insulating material. If the SEU-15 is used, it *must* be insulated from the plate lines and ground, for the condenser is not at any potential. The frequency range of the oscillator may be extended somewhat by increasing the lengths of the homemade rotors and changing the spacing between the plate lines; changing the lengths of the plate lines will also alter the frequency range.

Working with u.h.f. circuits usually involves a certain amount of machine work. This should not discourage any interested and mechanically inclined technicians. It is well said: "The u.h.f. engineer is a glorified plumber!"

Figs. 5-a and 5-b show the oscillator mounted on a lucite base 11 x 3 1/2 x 1/2 inches. The edges should be rounded off with a file so that the base can be mounted in a rectangular brass box 11 x 3 1/2 x 3 1/2 inches (conventional chassis do not provide sufficient shielding). Two holes should be cut in this box, in which two Centralab feed-through condensers of from 55 to 100 µµf may be soldered. These are for the A+ and B+ leads, although suitable 2- and 3-conductor connectors and cable are available. Feed-through condensers act as by-pass condensers at these higher frequencies and help prevent the formation of standing waves inside the chassis.

(Continued on page 58)

PREPAID ASSORTMENTS GUARANTEED FIRST QUALITY

100	1/3 Watt Resistors All Insulated	\$2.98
100	1/2 Watt Resistors All Insulated	3.98
100	1 Watt Resistors All Insulated	4.45
50	2 Watt Resistors All Insulated	3.98
50	200 Volt Paper Condensers	2.48
50	Mica Condensers	2.98
20	Dry Electrolytic Filter Condensers	6.75
10	25 ft. Rolls Hookup Wire—Ass'd colors	1.98
10	Volume and Tone Controls—No Switches	1.98
100	ft. Spacchetti and Vinylite	.98
10	Coils L.P., R.F. Ant. and Gae.	3.98
20	Wafer and Ceramic Band Switches	3.98
20	Auto Suppressors	2.98
50	Electrical Wiring Devices, Plugs, Taps, Bases, Elements, Fuses, etc.	5.00

SEND FOR TRUTONE COMPLETE RADIO AND ELECTRICAL LIST

Terms: 25% deposit required with order. Balance C.O.D. Merchandise sent prepaid if full remittance accompanies order.

TRUTONE PRODUCTS CO.

303 W. 42nd St. Dept. C New York 18, N. Y.

JUST PUBLISHED!



TWO NEWCOMERS TO...

HERE are two brand-new books, just off the press—both important additions to RADIO-CRAFT'S 1946-7 NEW MODERN LIBRARY SERIES. Last month five other fresh titles were announced (see list to the right). Watch this page for further titles each month.

"Easy-to-read, easy-to-grasp, easy-to-apply"—is the best way to describe the books in this popular series. Let them be your working tools to a better understanding of radio—to help you achieve higher goals. You will like the handy size, the fresh up-to-date type, the good printing, the carefully drawn schematics, and the flexible covers in attractive modern dress. 64 pages. Price 50c each, postpaid.

NO. 33 AMPLIFIER BUILDER'S GUIDE

A valuable book for the designer and constructor of sound equipment. Theory and construction of audio amplifiers are treated in separate parts. The theory section contains an unusually wide range of technical information on such subjects as r-c amplifiers, phase inverters, equalizing phonograph pickups and volume expansion.

NO. 37 ELEMENTARY RADIO SERVICING

A book for the radio man who knows little about radio repair. It shows how to get started and keep going. A wide range of essentials is covered in logical sequence: Planning and Equipping the Shop, Systematic Circuit Checks, Signal Tracing Methods, Servicing Midget Receivers and other fundamental servicing topics.

SEE YOUR DEALER.

IF HE CAN'T SUPPLY YOU, USE COUPON.

RADCRRAFT PUBLICATIONS Dept. 37
25 W. Broadway, New York 7, N. Y.

Kindly send me the volumes (50c each, postpaid) checked.

- ALL 7 BOOKS
- No. 29
- No. 30
- No. 32
- No. 33
- No. 36
- No. 37
- No. 38

I enclose \$.....

Name

Address

RADIO CRAFT NEW MODERN LIBRARY SERIES

50¢ each

Here Are Five Other Recent Titles

- # 29 HANDY KINKS AND SHORT CUTS
- # 30 UNUSUAL PATENTED CIRCUITS 1944-1946
- # 32 ADVANCED SERVICE TECHNIQUE
- # 36 RADIO TEST INSTRUMENTS
- # 38 HOW TO BUILD RADIO RECEIVERS

**RADIO PARTS
SOUND SYSTEMS
ELECTRONIC
APPARATUS**

**Depend on
RADOLEK**

Radolek's big Free Profit Guide Catalog and Profit Bulletin supplements keep you abreast of the rapidly changing radio situation. Buying from Radolek means greater values, better service and more profits. Make Radolek your buying headquarters.



RADIO PARTS



SOUND SYSTEMS

**FREE
CATALOG**



**Large Stocks
Fast Service**

SEND TODAY!

RADOLEK CO., Dept. C-115,
601 W. Randolph St., Chicago 6, Ill.
Please send your FREE Profit Guide Catalog.

Name.....

Address.....

SAVE AT RADOLEK

WORKING ON 50 AND 420 MC

(Continued from page 57)

sis and on supply lines. The construction of this shield box may be postponed until the oscillator has been placed in satisfactory operation.

As indicated in Figs. 5-a and 5-b lucite block A is mounted 3 inches from one end of the lucite base so that the tube may be removed easily from its socket. Lucite blocks B and C support the plate lines. Block C should be situated so that it will not interfere with the closing of the C3 rotor. Slits 1/16-inch wide are cut in blocks B and C to a depth that permits the plate lines to be flush with the condenser rotor when the latter is in a horizontal position (maximum capacitance). Approximate dimensions are given here to permit adjustment. However, the plate lines should be raised about one-half inch off the base. Blocks B and C are tapped for 4-40 machine screws which are used to keep the plate lines firmly anchored. Blocks A, B, and C are mounted on the lucite base with 7/8-inch 6-32 flat-head machine screws. If round-head screws are used, provision should be made for countersinking them. All hardware should naturally be brass.

The plate lines should clear the pins of the tube socket by about 1/4-inch. The leads from the plate pins to the plate lines should be about 1/4-inch long and should be cut from about 0.030-inch sil-

ver-plated brass or phosphor-bronze foil, if available. Otherwise, No. 16 tinned bare wire can be used.

Construction should start with mounting the tube socket and block A. Actual wiring will take only a few minutes. R.f.c. 1 consists of two turns of No. 18 tinned, bare wire, spaced about 1/16-inch, and 1/4-inch in diameter (a homemade air-core solenoid). A single-unit terminal strip mounted on top of block A provides a firm anchor for this cathode coil and for the 200-ohm 1/2-watt cathode resistor. The other end of R2 which rests on top of block A terminates in a second single-unit terminal strip mounted near the other end of block A. It is necessary to experiment a little here to get the leads of R1 and R2, and r.f.c. 1 short enough for the desired frequency range. The second terminal strip is the common ground and should be connected to the box after the oscillator has been mounted in the brass box.

Two 0.045-inch holes are drilled in the middle of the plate lines and r.f.c.'s 2 and 3, consisting of 6 turns of No. 18 tinned (bare) wire, spaced 1/16-inch and 1/4-inch in diameter (air-core solenoids as indicated above), soldered in these holes and to single-unit terminal strips appropriately mounted on the lucite base. R.f.c. 4, the same size

(Continued on page 65)

ESSE SPECIALS!

- Marker Beacon Receiver
BC-341-A
Complete with tubes.
Price \$4.95 ea.
- BC-434 and BC-524
AIRCRAFT RECEIVER
made by Setchell-Carlson and Detrola.
Your choice.
Price \$4.95 ea.
- BC-274-N COMMAND SET
Complete with 3 receivers: 3-6 Mc, 6-9.1 Mc and 190-550 Kc. Two transmitters, modulator and mounting racks. All tubes and crystals included.
Price \$24.95 ea.
- BC-211 and BC-221
FREQUENCY METERS
complete with tubes and crystals.
Price \$35.00

- INTERVALOMETER
Used to release bombs at various intervals with electronic timer that can be adapted to other purposes such as photography, etc.
Price \$1.75 ea.
- 24 V.—600 Watt GRIMES
Retractable Landing Lights
Excellent motor for model locomotives, etc. Wire 4 lights in series for powerful flood light operated from 110 V. AC or DC supply.
Price \$3.50 ea.
- This equipment has been removed from surplus aircraft and is only slightly used—some not at all. Order while the supply is plentiful. Prices are FOB location.

TERMS: CASH WITH ORDER OR 25%—BALANCE C.O.D.

All Items Shipped Collect

ESSE RADIO COMPANY
130 W. NEW YORK ST., INDIANAPOLIS 4, IND.

TUBES! TUBES!

- 6SK7
- 6B4G
- 5U4G
- 6SA7
- 6H6
- 6H6G
- 6SN7
- 6AG5
- 5T4G
- VR150-30
- 6SL7GT
- 6SN7GT
- 6N7
- 6AG7
- 6AC7
- 6SJ7

**40c
EACH**

- 2X2
- 6L6
- VR105

**50c
EACH**

Sold in quantities of 10 or more only. These are new tubes removed from radar components. Tubes are checked thoroughly before shipment. However, to make these prices possible, no returns, exchanges or guarantee can be allowed.

ESSE Specials!



PE-103 Dynamotor Unit

Brand new. Used to power your field or mobile transmitter. Designed for use with the BC-654 transmitter and receiver. Input—6 V DC 21 amps.; 12 V DC 11 amps. Output—500 V DC 160 Ma. Filtered output. Hi-Current relay switches, and overload protect switches self contained in unit. Shipped in original overseas moisture-proof container. Wt. of unit 53 lbs.
Price, brand new, each..... **\$ 9.95**



Ohmite

150-watt Model L Potentiometer, 7.5 and .5 ohms.
Price, brand new, each..... **\$1.95**



Thoradson T-52R21. Plate and Filament—Secondary 389-0-389 at 200 Ma 5 V 3 amp. and 6.3 V 5 amp 110 V 60 cycle per. A real replacement transformer for large sets.
Price, brand new..... **\$3.75**

Brand New Meters

- 2" 0-100 Ma. DC McClintock Co..... **\$3.45**
- 2" 0-150 V. DC Gruen..... **3.45**
- 3" 0-10 Ma. DC Westinghouse..... **4.50**
- 3" 0-500 Ma. DC Westinghouse..... **4.50**

Ohmite
Model J — 50-watt Potentiometer, 6 ohm.
Price..... **\$1.25**

Ohmite
Model M — 25-watt Potentiometer, 350 ohm.
Price..... **\$0.85**



Filter Choke

20 Henry, 50 Ma.
200 ohms DC.
Price..... **75¢**

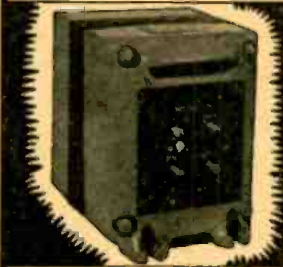

Thoradson—1060 V CT secondary 300 VA. Pri.—200, 220, 240 V 60 cycle AC.
Price, brand new..... **\$6.50**



Electromode Hot Air Heater

This is a heater used to heat the trucks of the SCR-299 mobile units—which proved highly successful during the war. Operates from 110 V AC or DC—1,500 watts. Contains blower unit for forced air heating which can also be used for fan during warm weather. Thermostatically controlled with motor protect Thermostat.
Price..... **\$29.50**

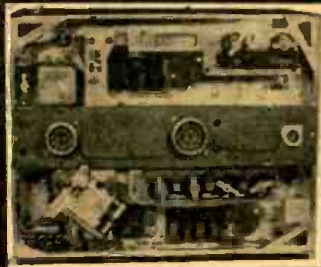

SCR-522 100-156 Mc. Receiver and Transmitter

One of the most interesting and useful pieces of surplus equipment. Designed for plane and ground station use, this unit offers remote control of any four pre-selected crystal controlled frequencies in the spectrum of 100-156 Mc. This spectrum covers facsimile, air navigation aids, airport control, railroad, police, urban telephone, as well as the amateur band 144-148 Mc. October Radio News gives details for converting the SCR-522 receiver section, BC-624.
Transmitter section, BC-625. Is voice amplitude modulated and has an output of 8-9 watts.
Tubes used and included 2—832, 3—12A6, 1—6C6, 2—6X17, 1—12J5GT, 3—12SG7, 1—12CB, 1—900Z, 3—900J, 1—12AH7GT.
Used, with tubes, less dynamotor and remote control
Price..... **\$29.75**

Triplet Model 65B-SC-AC Voltmeter and Output Meter
—Scale 1.5, 6, 15, 60 and 150 V 4000 ohms res.
Price, brand new, with fast leads..... **\$13.50**



Thoradson—110 V 60 cycle per. sec. 440 V CT 150 Ma and 5 V 3 amp.
Price, brand new..... **\$2.25**



Selsyn Motors

Use Selsyns for direction indicators of beams, wind, etc. Operate from 10-15 V., 60 cycle AC.
Price, each..... **\$1.75**
Includes plug.



BC-654-A Receiver and Transmitter

Truly the best buy of Army surplus. Frequency range 3800 to 5800 KC—calibration every 10 KC—with crystal oscillated check every 200 KC—power output 17 watts, voice or CW. Shipped as received from Signal Corps Repair Laboratories. Some in new condition with spare tubes, others lacking some tubes. Weight, 45 lbs.
Price..... **\$17.95**
PE-104 Vibrastr Power Supply for operation of BC-654-A receiver from 6 V. or 12 V. storage battery.
Price, new..... **\$4.95**

T-17-B Microphone

Brand new. A single button, carbon mike, hard to beat—and at the price. When ordering without additional merchandise, enclose 25¢ additional for postage and handling.
Same as above but used, either bakelite or aluminum model.
Each..... **95¢**



Filament Transformer

5 V. CT. 7.5 amp.
110 V. 60 cycle per.
Price, brand new..... **\$1.50**

Ceramic Stand Off Insulator

Use for stand off or mount two base to base for feed-thru insulator. Size 1 1/2" high, base diameter 2 1/8". You can't afford to be without them at the price.
Sold in dozen lots only
Price, each..... **\$0.05**



Leach Relay — 24 V. DC

Res. 160 ohms. Poles 3 and 4 make when magnetized. 5 and 6 when unmagnetized.
Price, brand new, each..... **\$1.95**

Relay — SPDT Type

6 ma. 5000 ohm DC resistance.
Price..... **\$0.85**

AN/ART-13 Collins Autotune Transmitter

A modern, compact, lightweight, high-powered transmitter. For frequency range 2-18.1 Mc. on any of its 11 auto tune crystal controlled or master oscillator channels. December Radio News gives conversion details for converting 24 V DC operation to 117 V AC. These units removed from planes. Checked and guaranteed. Weight, 67 lbs.
Price..... **\$134.50**
1 COMPLETE WITH DYNAMOTOR UNIT

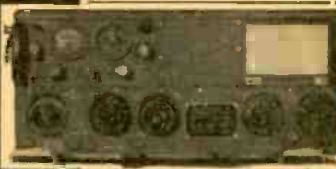

Headphones

Signal Corps 4,000 ohm magnetic and headband.
Price..... **\$1.87**
Headphone Extension Cords for Signal Corps phones. PL-55 plug on one end, JK-26 on other. 60" length—used.
Price..... **\$0.75**

TERMS:
CASH with ORDER
or 25%
BALANCE C.O.D.
All Items
Shipped Collect



ESSE Radio Company

130 W. New York St. Indianapolis 4, Ind.

AMPLIFIER

For Call System or
Phono. Amplifier

\$2.95

- Complete with tubes • Compact—wired
- Ready to Operate • Uses 35Z5—50L6.

N. J. INDUSTRIAL CO.

309 ELM ST.

NEWARK 5, N. J.



SERVICE MEN!

- RCA Radiotron • Sylvania
- Tungsol • Raytheon

Tubes, Parts & Equipment

Write for our latest bulletin Dept. C2

Distributors of RADIO EQUIPMENT

CHIEF ELECTRONICS

104 MAIN STREET, POUGHKEEPSIE, N. Y.
The Square Deal Supply House

SURPLUS SPECIALS

- R.C.A. 23-tube new Amplifiers MI-2545, \$50 ea.
- New Raytheon Magnetrans 2J32, \$15.00
- 5 BPI R.C.A. tubes with socket, \$4.95
- 10 mfd oil-filled 150v volt d.c., \$2.25

TIRET ELECTRIC CO.

46-47 Vernon Boulevard, Long Island City 1, N. Y.

ELECTRICIANS! RADIO MEN!

Earn More Money!

Get this new
GIANT SIZE

**ELECTRICAL
and RADIO
TROUBLE
SHOOTING
MANUAL**
GUARANTEED BY
COYNE

Yours 10 Days Free

NEEDED by Electrical and Radio Workers, beginners, old timers! None else like it. Saves time, helps boost your pay.

4 GREAT BOOKS IN ONE!
1. New Step-by-Step Trouble Shooting Course. 2. 500 Shop Prints. 3. Electrical-Radio Dictionary. 4. Spare Time Jobs.

FREE! 1 year Technical Counsel by mail from COYNE staff, on trouble-shooting problems.

SEND NO MONEY! See offer below. Satisfaction guaranteed by the famous COYNE "Learn-by-Doing" Electrical School. **RUSH COUPON TODAY!**

OVER 500
Large Size
Electrical and
Radio
Shop Prints
-How to read
and use them

Educational Book Publishing Division
COYNE ELECTRICAL SCHOOL, Dept. 37-72, **COUPON**
500 S. Paulina St., Chicago 12, Ill.
Send, postage-paid, Coyne's new Electrical and Radio Trouble
Shooting Manual. In 10 days I'll either return it or send \$3, then
\$3 monthly until total of \$7.50 is paid. Cash price: \$6.95. You
save 55c. Same 10-day free trial and return privilege.

NAME _____ Age _____
ADDRESS _____
CITY _____ Zone _____ STATE _____

Japanese radio production is increasing more rapidly than that of even the United States. Early last autumn receivers were being produced at a rate exceeding 75,000 per month. Tubes were a bottleneck but were being produced at the rate of 230,000 per month, including a few repeater, transmitter and other non-receiving tube types.

Steps are being taken to improve the quality of radio sets turned out and all plants are establishing quality control systems to insure higher-quality production.

TELEVISION FOR TODAY

(Continued from page 34)

beam horizontally across the screen. In the horizontal circuit this is the width control. In the vertical system, it controls image height.

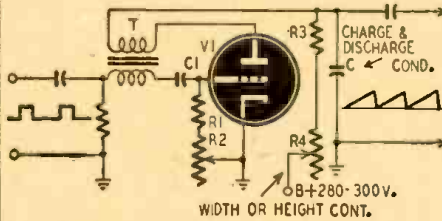

Fig. 7—A saw-tooth-wave blocking oscillator. Two sets of values appear at end of article.

The Multivibrator

Another popular oscillator circuit is the multivibrator. See Fig. 8. Essentially the multivibrator is a two-stage cascaded amplifier, with the output of the second tube fed back to the input of the first stage. Oscillations are possible because any voltage at the grid of V1 produces an output at V2 which is in phase with the original voltage.

Briefly, the operation of the multivibrator is as follows: Due to some disturbance in the circuit, the voltage across one of the grids, say V1, will rise. The increased current, as a result, will lower the plate potential of V1. Since the grid circuit of V2 is coupled to this point (via C1), the decrease will appear as a negative voltage across Rg2 and Rg3. This will decrease the plate voltage to rise. The positive voltage is coupled back to Rg1 (through C2) and

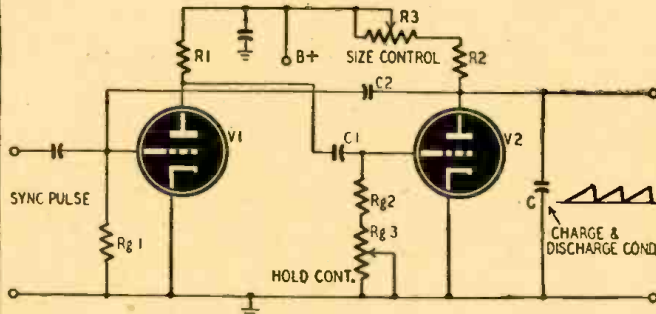

Fig. 8—A multivibrator saw-tooth-wave generator. Values in text.

aids the disturbance. The continuation of this action, causing the current through V1 to increase and that through V2 to decrease, is cumulative and rapidly brings V2 to cut-off.

The length of time that V2 will remain in this condition depends upon the time constant of C1, Rg2 and Rg3. Before V2 can conduct again, the accumulated negative charge on C1 must leak off through Rg2 and Rg3 and the low resistance of V1. As soon as the charge has been lowered sufficiently to permit current flow through V2, the previous set of conditions are reversed. The plate current of V2 increases, coupling back (through C2) a negative charge to the grid V1. Following the foregoing reasoning, V1 is quickly brought to cut-off and V2 conducts.

To generate a saw-tooth wave, the condenser C can be placed as shown in Fig. 8. When V2 is nonconducting, the full B-plus voltage is applied to the condenser and it charges. To discharge it, negative pulse is applied at the grid of V1, driving it into cut off and sharply pulling V2 out of cut off. The rapid transition or flip-over is caused by the coupling of a positive charge from the plate of V1 (due to its being brought from full conduction to cut-off) to the grid of V2, via C1. The positive pulse thus transferred is capable of overcoming whatever residual negative charge still remain in C1.

In designing the network, the time constant of C2 and Rg1 is made considerably longer than that of C1 and Rg2 plus Rg3. The ratio is generally on the order of 9 to 1. One cycle in the horizontal oscillator lasts for 1/15,750 sec., and it is simple to compute the time constant of each. If the multivibrator is used in the vertical system, the time of one cycle is 1/60 sec.

Before leaving synchronizing oscillators, mention should be made of a modified multivibrator which has been widely used. Its circuit, shown in Fig. 9, uses a coupling condenser C1 and the non-bypassed cathode resistor Rk which is common to both tubes.

C charges during the interval that V2 is nonconducting. If, at the proper moment, a sharp negative synchronizing pulse is applied to V1, the plate current will decrease and a positive pulse will be transmitted to V2 through

C1. The plate current of V2 rises sharply, the tube resistance decreases, and C discharges through this low-resistance path.

Tube V1 is held to cut-off by the applied negative voltage and the large cathode bias developed as a result of the momentary large plate current

of V2. V1 will remain in this nonconducting condition until the grid of V2 becomes blocked due to the flow of grid current resulting from the positive pulse transmitted through C1. When

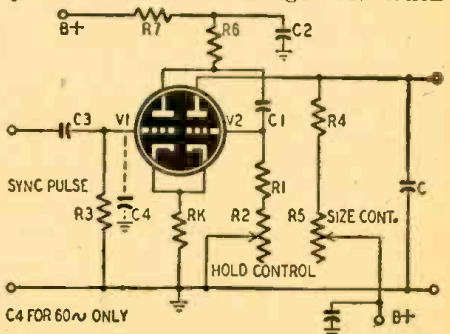

Fig. 9—Multivibrator with cathode coupling.

this occurs, the large negative bias is removed from the cathode resistor and V1 is again permitted to conduct. The length of time that V2 is held nonconducting will depend upon the time constant of C1 and both grid-leak resistors. As soon as the negative voltage here has diminished sufficiently to permit conduction, the switch over from V1 to V2 occurs. For synchronization, the negative pulses applied to V1 should arrive slightly before the switch-over would naturally occur.

Typical Values of Components

Figure 7.

60 Cycles	15,750. Cycles
V1-6J5	V1-6J5
C1-3,300 µf	C1-820 µf
R1-1.2 megohms	R1-33,000 ohms
R2-1.2 megohms	R2-50,000 ohms
R3-1.0 megohms	R3-47,000 ohms
R4-2.0 megohms	R4-500,000 ohms
C-0.1 µf	C-500 µf
T-Best if one is bought which is specially designed for this purpose. These are currently available.	T-A small audio interstage transformer (3:1 ratio).

Figure 8.

V1-½ 6SN7	V1-½ 6SN7
V2-½ 6SN7	V2-½ 6SN7
Rg1-2.2 megohms	Rg1-220,000 ohms
Rg2-270,000 ohms	Rg2-68,000 ohms
Rg3-1.0 megohm	Rg3-50,000 ohms
R1-100,000 ohms	R1-47,000 ohms
R2-1.0 megohm	R2-47,000 ohms
R3-2.0 megohms	R3-500,000 ohms
C-0.1 µf	C-500 µf
C1-0.01 µf	C1-0.001 µf
C2-0.05 µf	C2-0.005 µf

Figure 9.

V1 } 6SN7	V1 } 6SN7
} 6N7	} 6N7
V2 } 6F8	V2 } 6F8
R1-1.2 megohms	R1-33,000 ohms
R2-1.2 megohms	R2-50,000 ohms
R3-2.2 megohms	R3-2,000 ohms
R4-1.0 megohm	R4-470,000 ohms
R5-2.0 megohms	R5-500,000 ohms
R6-100,000 ohms	R6-47,000 ohms
R7-100,000 ohms	R7-100,000 ohms
C-0.1 µf	C-500 µf
C1-0.01 µf	C1-0.001 µf
C2-0.1 µf	C2-0.006 µf
C3-0.01 µf	C3-50 µf
C4-0.001 µf	C4-not necessary
Rk-470 ohms	Rk-470 ohms

EASY WAY TO STUDY CODE

Thousands of persons are now studying the International Code. Small groups of neighbors can study code if one of the group owns a broadcast receiver with a microphone jack for home "broadcasting," a microphone of the single-button carbon variety, a key and a buzzer or a small code oscillator.

Arrange the microphone, after plugging it in, so it will sit close to a high-pitched buzzer of suitable character. Place the buzzer as close to the mike as possible so its faint sound will be sufficiently amplified by the receiver. With a code oscillator, use either a small PM speaker or a headphone and place that as close to the mike as necessary. The exact arrangement must be determined by experiment.

Turn on the receiver and tune to a quiet spot on the dial between stations, first disconnecting the antenna and ground. Plug in the mike and hold down the key to obtain a sustained note. Then the volume control of the receiver can be turned up until the sound can be heard easily by all the students.

L. B. ROBBINS,
Harwich, Mass.

(Sometimes all that is necessary is to place the mike before the speaker and key it.—Editor)

AMERICA'S TOP QUALITY AMPLIFIER

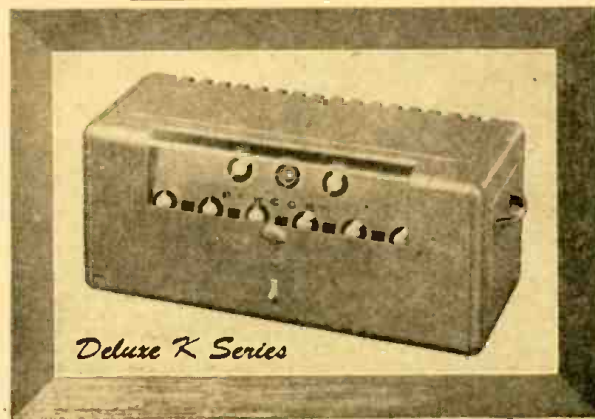

Deluxe K Series

A reputation for quality is our most priceless asset. The performance and operation of the Newcomb Deluxe K-Series of amplifiers form outstanding proof of the reason for that reputation.

Incorporated in every K-Series model is a combination of control features never before offered in any amplifier, plus—Uniform power output throughout the useful band of frequencies . . . Frequency response: 20 to 20,000 cycles within 1 d.b. . . Master volume control . . . Individual, dual-acting tone controls for bass and treble . . . Thru-vision, plastic keylock control panel cover . . . Exclusive plug-in input transformer socket for instant conversion from high to low impedance . . . and many other features that spell top quality in sound reproduction.

• All NEWCOMB amplifiers are precision-built, tested and re-tested, to guarantee laboratory performance and long, dependable operation.



Dept. C, 6824 Lexington Avenue • Hollywood 38, California

Send for details of our complete line of sound equipment.

PHONO PLAYER KITS

TABLE MODEL, dual tube amp, five inch speaker, light weight crystal pickup, attractive two tone cabinet and quiet rim drive motor.	
MODEL RCP4 complete	\$15.95
WIRELESS PHONO PLAYER, tune it in on any radio. MODEL RC5W complete	14.35
PHONOGRAPH ATTACHMENT, plays through any radio. MODEL RCSA	9.85

AMPLIFIER KITS

3 TUBE KIT, RC3	3.80
2 TUBE KIT, RC2	2.60
1 TUBE KIT, RC1	2.10
PHONO OSCILLATOR KIT, RC1W	2.90

• Tubes are available for all amplifier and oscillator kits and are supplied with all complete player kits. • Send for list of special low prices on record player parts.

HALLMARK ELECTRONIC CORP.

592 Communipaw Ave., Jersey City 4, N. J.

AMAZING NEW RADIO!



Pocket or Purse size SMALL AS A PACK OF CIGARETTES! Weighs only a few ounces—Beautiful black chrome plastic case. Uses new war born crystal diode, HI-Q slide dial. NO tubes, batteries or electric "plug-ins." Usually receives local broadcasts without outside aerial wires.

GUARANTEED TO PLAY when used according to instructions sent with each radio! You can use it at home, in offices, hotels, cabins, in bed, etc.—lots of fun—real entertainment!

Send Only \$100 (cash, money order, check) and pay postman \$2.00 plus delivery fees on arrival or send \$3.99 for postpaid delivery. Complete as shown Ready to Play with self contained personal phone. For Gifts—children will love it—grown-ups too! An exceptional value—order yours and enjoy the many good radio programs coming! Don't be without your Pa-Kette Radio another day! (All foreign orders \$3.00 U.S. cash.)

Pa-Kette Electric Co. Dept. RC-3 Kearney, Nebraska

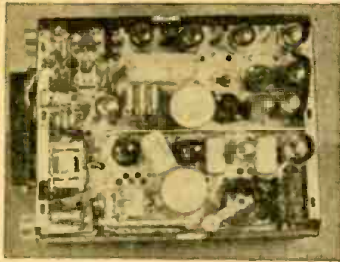

General Electric RT-1248 15-Tube Transmitter-Receiver
TERRIFIC POWER (20 Watts) on any 2 instantly selected, easily pre-adjusted frequencies from 435 to 500 Mc/cycles. Transmitter uses 5 tubes including a Western Electric 316 A as final. Receiver uses 10 tubes including 255's as first detector and oscillator, and 3-7B7's as IF's, with 4 slug-tuned 40 MC. IF transformers, plus a 7H7, 7E6's, and 7F7's. In addition unit contains 3 relays designed to operate any sort of external equipment when actuated by a received signal from a similar set elsewhere. Originally designed for 12V operation, power supply is not included, as it is a cinch for any amateur to connect this unit for 110V AC, using any supply capable of 400V DC at 135 MA. The ideal unit for telephone use as in a taxicab, or for any kind of remote control applications as with drone airplanes. Instructions and diagrams supplied for running the RT-1248 transmitter on either code or voice, and for using the receiver as either an AM or FM set. As an FM set, the receiver section of the 1248 is capable of better results than almost any of the commercial FM sets on the market, largely as a result of the superb engineering and meticulous workmanship employed in constructing the converter, oscillator and IF sections. Supplied in original cartons with 15 tubes. Your cost \$29.00—10% less if ordered in lots of 2 or more. If desired for marine or mobile use, the dynamotor, which will work on either 12 or 24 VDC and supply all power for the set, is only \$15.00 additional.

Famous Collins Autotune Transmitter

This is the well known unit used in Army and Navy planes that features automatic motor tuning of any of 11 front-panel preselected frequencies up to 18,100 Kc, as well as manual tuning at any time. The transmitter operates on voice, CW, and MCW on all frequencies. This beautifully designed unit uses an 813 final, and push-pull 811's as modulator, measures 23½x13¼x11, and weighs 70 lbs. Estimated average power output is 150 Watts. Price including dynamotor—\$139.95. Write for literature describing any units you wish more information on.

BENDIX SCR-522

Very High Frequency Voice Transmitter-Receiver—100-to-156 MC. **THIS JOB WAS GOOD ENOUGH FOR THE JOINT COMMAND TO MAKE IT STANDARD EQUIPMENT IN EVERYTHING THAT FLEW EVEN THOUGH EACH SET COST THE GOVT. \$2500.00.** Crystal Controlled and Amplitude Modulated—High Transmitter Output and 3 Microvolt Receiver Sensitivity gave good communication up to 180 miles at high altitudes. Receiver has 10 tubes and transmitter 7 tubes, including 2-832's. Furnished complete with 17 tubes **AND POWER SUPPLY** for 12 or 24 volts, also remote control boxes and cable connectors. We include complete diagrams and instructions for the simple conversion of the 522 to full 110-Volt, 60-Cycle operation. Your cost \$44.50

Six Band Communications Receiver

Featuring continuous coverage from 1500 Kc to 18,000 Kc on a direct reading dial with the finest vernier drive to be found on any radio at any price—extreme sensitivity with a high degree of stability—crystal filter and phasing control—BFO—antenna compensation—transmit-receive relay—standard 6 volt tubes. Contains a plate supply dynamotor in compartment within the handsome black crackle finish cabinet, the removal of which leaves plenty of room for installation of a 110V, 60 or 25 cycle supply. These new receivers, which make any civilian communications receiver priced under \$200.00 look cheap and shabby by comparison, are only \$44.50. Power supply kit for conversion to 110V, 60 Cycle, is only \$8.50 additional.

TITANIC INSTRUMENT BARGAINS

—BC-221 Frequency meters with calibrating crystal and charts—\$39.95.
RADAR OSCILLOSCOPE, complete with 27 tubes including 5" Cathode Ray tube—\$39.95.
RADAR OSCILLOSCOPE, complete with 29 tubes including 3" Cathode Ray tube—\$39.95.
PUBLIC ADDRESS AMPLIFIERS—25 Watts peak output, complete with 5 tubes, separate controls for Microphone and Phono Inputs, \$65.00 value for only \$32.00.

GENERAL ELECTRIC 150-WATT TRANSMITTERS ... NOW ONLY \$44.50

These units manufactured for the Army Air Forces during the war by General Electric are now available at a price every amateur can afford. They are the same brand new transmitter, complete with seven plug-in tuning units, antenna tuning unit, dynamotor, connector plugs, cables, all tubes, and instruction book, which sold for as high as \$175.00 last year. These transmitters have a frequency range of 200-500 Kc. and 1500-12,500 Kc. and will operate on the 10 and 20-meter bands with slight modification. Instruction booklet for conversion to 110V, 60-Cycle is also included. Transmitter dimensions are 21½ x 23 x 9¼ inches. Total shipping weight 250 lbs. **Order yours NOW** for the lowest price at which this model has ever been sold **COMPLETE** \$44.50

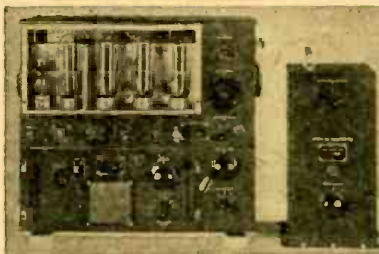

AIRCRAFT MARKER BEACON RECEIVER—Complete with 3 tubes and sensitive relay to control external circuits from received signals. Just the receiver you have been waiting for to control models, open doors from a distance, etc. Priced at only—\$4.95.

BC-654 TRANSMITTER-RECEIVER—Brand New, complete with 200 Kc. calibrating crystal and 17 tubes—\$39.95.

AIRPLANE INTERCOM AMPLIFIER—Complete with 4 tubes in aluminum case—\$4.95.

RADAR RECEIVER—Suitable for sound or video reception. Includes 13 tubes and 200 MA motor—\$27.50.

BUFFALO RADIO SUPPLY • 219-221 Genesee St., Dept. 3C • Buffalo 3, N. Y.

Still the BEST BUY in a COMBINATION TESTER

RCP Model 802N
COMBINATION TUBE-SET TESTER



Immediate Delivery from stock.

A complete tube tester and a complete set tester, with only 5 simple switches to operate for both tube and set tester combined.

RANGES

DC VM. 0/10/50/500/1000 at 1000 ohms Per v.
 AC VM. 0/10/50/500/1000.
 DC MA. 0/1/10/100/1000 DC Ammeter 0/10.
 Ohmmeter 0/500/5000/1,000,000/10,000,000. Low ohm center.
 D.B. Meter—8/15/15 to 29/29 to 49/32 to 55 db.
 Four range output meter—same as AC volts. Size: 12½x12x5½ inches. Weight: 11½ lbs. Complete in handsome hardwood case, with test leads, self-contained batteries, ready to operate. **NET \$59.50**

ADSON RADIO CO.
 221 FULTON ST., NEW YORK 7, N. Y.

Headset Headquarters



Folder R-3 illustrates complete line of Guaranteed

CANNON-BALL HEADSETS

Beautifully designed. Light in weight. Efficient. Reproduces with clarity and good volume. Write

Scientifically Built Heavy bar magnets greatly increase their efficiency.

C. F. CANNON COMPANY
 SPRINGWATER, N. Y.

DUTCH UNDERGROUND RADIOS

(Continued from page 26)

think it was because of the high sensitivity of the set. A ground was provided by the old telephone ground line.

To operate the set you had to turn the dial to seven and pick up the earphone. After that you could wait for Big Ben.

To avoid discovery by anybody who might want to use the telephone and by chance turn the dial to seven, I put a piece of paper above it. "Pas op! Niet gebruiken, Defect." This means in English: "Take care. Don't use. Defective!"

In September, 1944, the Airborne Troops came down over our town and Arnhem had to be evacuated. When I returned everything in the house had been stolen, except my receiver! The Hun had not discovered it!

In Aalten, to which I was evacuated, a town of about 10,000 inhabitants, it wasn't so very difficult to listen to the Voice of Freedom, because there were not so many Nazis in the village.

The man whose house was my home for some time never had a receiver before the war, but now he had one.

It was made by the serviceman in the village and gave very satisfactory results. The circuit diagram is given in Fig. 6 and you can see it is a very common type of regenerative detector.

The tube used is an EF-g, a tube somewhat similar to the 6K7 but with better power output.

Tuning is by an iron-core coil and a variable condenser (L1, C1). The circuit regenerates by means of the tickler coil L2, and is controlled by C2.

Two plug-in coils, made from old

**PAS OP!
 Nietgebruik
 en Defect!**



Fig. 5—A real radio-telephone.

ALL ITEMS LISTED BELOW NOW AVAILABLE FOR IMMEDIATE DELIVERY *from* STOCK



Our Policy: All units are sold subject to one year guarantee except when components are damaged through misuse. We do not solicit orders for any unit that does not meet our requirements for accuracy and honest value. Any item purchased from us is sold with the understanding that it may be returned for full refund after a 10 day trial.



SEE and HEAR the Signal with the new CA-12 SIGNAL TRACER

FEATURES:

- * Comparative intensity of the signal is read directly on the meter—Quality of the signal is heard in the speaker.
- * Simple to operate—Only one connecting cable—

No tuning controls.

Highly sensitive—Uses an improved vacuum-tube voltmeter circuit. *Tube and resistor capacity network are built into the detector probe. *Built-in high gain amplifier—Alnico V speaker. *Completely portable—Weighs 8 pounds—measures 5½" x 6½" x 9". Complete with self-contained batteries and instructions **\$34.85**

The New Model 450 TUBE TESTER

SPEEDY OPERATION assured by newly designed rotary selector switch which replaces the usual snap, toggle, or lever action switches.

Specifications:

- * Tests all tubes up to 117 Volts.
- * Tests shorts and leakages up to 3 Megohms in all tubes.
- * Tests individual sections in multi-purpose tubes.
- * New type line voltage adjuster.
- * Noise Test: Tip jacks on front panel for plugging in either phone or external amplifier will detect microphonic tubes or noise due to faulty elements and loose internal connections.
- * Works on 90 to 125 Volts 60 Cycles A.C. Complete with all operating instructions. **\$39.50**



The New Model 670 SUPER METER

A Combination VOLT-OHM MILLIAMMETER plus CAPACITY REACTANCE INDUCTANCE and DECIBEL MEASUREMENTS.

Added Feature:

The Model 670 includes a special GOOD-BAD scale for checking the quality of electrolytic condensers at a test potential of 150 Volts. Complete with test leads and operating instructions **\$28.40**

The New Model B-45 SIGNAL GENERATOR

Self-modulated—provides a highly stable signal. RF frequencies from 150 Kc. to 12.5 Mc. on Fundamentals and from 11 Mc. to 50 Mc. on Harmonics. Modulation is accomplished by gridlocking action—equally effective for alignment of amplitude and frequency modulation as well as for television receivers. Self-contained batteries. All calibrations are etched on the front panel. Complete, ready to operate **\$27.75**



20% DEPOSIT REQUIRED ON ALL C.O.D. ORDERS

GENERAL ELECTRONIC DISTRIBUTING CO., Dept. R.C.

98 PARK PLACE, NEW YORK 7, N.Y.

tube sockets, were available, one for 200 kc. and one for 1000 kc. The former tuned in BBC; the latter, the broadcasting station in already liberated Holland.

The set was fed by external batteries, but the receiver itself was placed in a small wooden box and looked very good.

Later on the detector was coupled to a power amplifier which drove a 5-inch pm speaker. It gave the best results I have heard from a two-tube receiver.

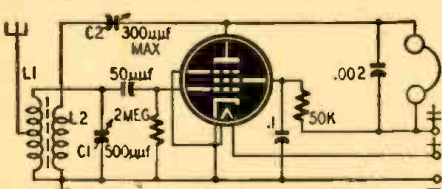

Fig. 6—Another standard underground receiver.



Close-up of one of the clandestine radios.

RADIO-CRAFT for MARCH, 1947

SCARCE TUBES

At Good Discounts
All Popular Standard Brands

New Guaranteed Sealed Cartons

024, 1LA6, 1LN5, 1P5, 2A3, 5Z4, 6AB, 2A5, 2A6, 6E5, 6F5, 6J8, 6K5, 6K8, 6P5, 6Q7, 7A8, 7B8, 7C5, 7B7, 7C5, 7F8, 7G7, 12AB, 12F5, 12X7, 12Z3, 14Q7, 14R7, 25A7, 25L6, 25Y5, 25Z5, 25Z6, 30, 32L7, 33, 35, 35A5, 35Y4, 35Z3, 43, 45, 47, 50A5, 50Y6, 55, 57, 58, 59, 70L7, 71A, 84, 117L7, 117M7, 117N7, 117P7, 117Z3, 117Z6, 22L and many others.

THIS MONTH'S SPECIALS!

Five-tube All-American Kit

50L6, 35Z5, 12SA7, 12SK7, 12SQ7 \$3.65
25Y5 exact replacement for 25Z5. List price \$3.20. Your cost 75c
Acorn Tubes guaranteed 954, 955, 956, 957, 49c each
6AK5 tubes guaranteed 75c each
Hearing Aid tubes. All types.
501AX, 509AX 49c each
6AH6 Tubes 49c each

Condensers, Brand New, Individually Boxed. Fully Guaranteed for one year. Used by leading radio manufacturers at a price you can't beat.

20/20 MFD at 150V 45c each
8 MFD at 450V 32c each
16 MFD at 450V 45c each
20 MFD at 150V 32c each

SPECIAL DISCOUNT ON ALL LARGE ORDERS

WRITE OR WIRE FOR CATALOG
WE SHIP ANYWHERE



COMMERCIAL RADIO

36 BRATTLE ST., BOSTON 8, MASS.

Department H

Total television hours in America's biggest television city (New York) amounted to 1,717 in 1946, *Radio Daily* reported last month.

The time was divided between New York's three television stations, with WNBT's 802 hours maintaining a lead

Electronics Made Easy!



Magi-Klips KIT

Build 18 Experiments at Home—
No Tools!

RADIO RECEIVER, HOME BROADCASTER, PHOTOELECTRIC RELAY, CODE PRACTICE OSCILLATOR, SIGNAL TRACER, REMOTE CONTROL RELAY, Phonograph Transmitter, Intercommunication Amplifier, Code Transmitter, Radio Frequency Oscillator, Telephone Line Amplifier, Electronic Switch, Phonograph Amplifier, Temperature Control Relay, Contact Detector, Electronic Metronome, Interval Timer (one-shot), Interval Timer (repeating).

With a Magi-Klips kit you cover the entire field of electronic engineering theory quickly in your spare time. It's simple to arrange the components for each circuit. No soldering. No tedious wiring. Kit operates on 110 v. AC or DC and includes 35Z5 rectifier, 50L6 power amplifier, 12SL7 double triode, powerful 4" speaker-mike, plate relay, broadcast and SV coils, tuning condenser and generous supply of resistors, condensers, chokes, extra wire. Parts worth double the price of kit.

Kit's 48-page manual has complete instructions and diagrams easily followed by the beginner. Remember, you need no tools, except possibly a screwdriver, with a Magi-Klips electronic experimenters' kit **\$39.95** complete

DEER & TAYLOR COMPANY
1340 Milvia St.
Berkeley 9, Calif.

Please ship Magi-Klips electronic kit (s).

I enclose \$.....

Please mail illustrated folder on the Magi-Klips kit.

Name

Street

City State

over WABD'S 625 and the 290 hours of WCBS-TV. Almost 35 percent of this time—606 hours—was commercial.

HARRISON HAS IT!

ALL STANDARD LINES

We are Factory Authorized Distributors for the top quality manufacturers and we now have in stock lots more new, latest improved production Ham gear! Visit our stores today, for everything you need. We promise you fresh, clean material—quicker—at the lowest current prices—and above all, our sincere desire to be of friendly, helpful service.

As one of the world's largest distributors of Communications Equipment, we are delivering plenty of

RECEIVERS

Right Now! ALL MAKES—practically all models. If you want your new set in the quickest possible time send your order to HARRISON! For example—

HALL-CRAFTERS—

S-38\$47.50	S-40\$69.50
S-36A, FM-AM-CW	—27.8 to 143 Mc.	\$37.50
S-37	—130 to 210 Mc.	\$91.75
SX-42—New FM-AM	—54 to 110 Mc.	\$275.00
HAMMARLUND—New "Super-Pro"			
SPC-400-X	—53 to 20 Mc.	\$334.05
Speaker in Cabinet—\$13.20			
HQ129X, complete with speaker in cabinet		\$173.25
NAT ONAL—			
NC-240-D—Complete with speaker		\$241.44
HRO-STA-1—Complete with Pack and speaker		\$306.71
RME-43—Complete with speaker		\$198.70
RM-E-84—Complete with speaker		\$87.70
Collins 75A-1	—\$375.00	Adapter\$99.50

TRANSMITTERS

Meek 80T\$150.00	Sonar Narrow Band FM	
Temco 75-GA\$95.00	Exciter\$39.45
Collins 327-L\$75.00	Collins 70 ES	
Temco 500 GA\$180.00	VFO Unit\$40.00

TEST EQUIPMENT?

Certainly! Harrison has it! We can supply practically anything for the Amateur, Serviceman, and Laboratory. Here are a few of the many items we have in stock right now for immediate delivery to you—(Even if what you want is not listed here, send us your order—we'll do the rest!)

MULTIMETERS

Supreme 543\$18.95	RCP 424 AP\$33.50
Precision 832-S\$23.04	Simpson 260\$8.95
Supreme 542-M\$26.15	RCP 461 AP\$43.57
Weston 564\$28.80	Triplet 625-N\$45.00
Triumph 323-S\$29.70	Triplet 2405\$67.75
Simpson 215\$32.50	Supreme 592\$8.95
Precision 844\$33.20		

OSCILLOSCOPES

National CRU\$39.90	RCA 155-C\$115
Dumont 274\$97.75	RCA 160-B\$185
Waterman Pocketscope.....\$66.00			

VACUUM TUBE VOLTMETERS

Silver "Vomax"\$59.85	Jackson 645\$75.00
RCA 195-A\$69.50	Hickok 203\$79.80
Hickok 125\$94.75		

SIGNAL GENERATORS

Jackson 640\$49.00	Supreme 576\$68.95
RCP 705\$49.50	Triplet 2432\$8.50
RCA 167-B\$63.75	Billey 1A Crystal Oscillator\$69.50

TUBE CHECKERS

RCP 315\$59.50	Jackson 636 CP\$62.50
Precision 912\$61.20	Precision 915\$44.41

TUBE AND SET TESTERS

Hickok 534\$138.30
Silver "Sparx" Signal Tracer\$39.90
Supreme 562 Analyzer\$127.00

HARRISON HAS IT!

HARRISON SELECT SURPLUS BARGAINS

The cream of the surplus market! Good—new—guaranteed material. Top value, always. You don't "take a chance" when you buy anything from Harrison!

★ TUBES—3C2A/24G HF Triode\$1.49
FIVE for\$5.96
2E29/629B
9092, 9093 FIVE for \$2.49

★ ANTENNA TUNER—BC 930-A (Half-crafters AT-3) Complete with Condensers\$29.95

★ ROTARY COAXIAL COUPLING—Continuous rotation, 52 ohm constant impedance—coaxial sockets each end. Lapp\$7.75

★ CRYSTAL CONTROLLED CALIBRATOR AND MONITOR—Navy CQG-61093. With spares\$4.95
(With batteries \$5.95)

★ KW MODULATION TRANSFORMER—1:1 ratio. Conservative 550 Watt Audio rating. Screen winding, 38 1/2 lbs.\$24.75

Antenna Wire, No. 10 Phosphor Bronze, stranded, 125 feet (2 Insulators at 75 feet)\$1.97

Stranded No. 8 copper wire, Heavy insulation, 125 feet in 7 foot lengths\$1.19

BC 406A 16 TUBE UHF RECEIVERS

Been getting such FB reports from our customers about these swell Signal Corps Radar receivers that we just had to get more for you. Six acorn tube RF circuit, tuned to 205 MC; four IF stages; Thordarson heavy duty power transformer delivering 350 volts at 145 MA; four choke and oil condenser filters; 11 watt 2/3 RPM AC motor; 115 volt 60 cycle operation; chassis 10 1/2" x 23 1/2". In metal case. Slightly used but fully guaranteed. Complete with tubes: 5-954's, 1-955, 4-68K7, 2-68J7, 1-68N7, 1-5T4.

Instructions and diagrams for easy conversion to a hot 10 (also 6 and 2) meter superhet receiver are included. The parts alone are worth much more than our low HSS Price.\$29.75

(Please see our previous ads for full descriptions of above items)

COMPACT VIBRATOR PACK

FB for transceivers, portable receivers, etc! Delivers: 135 volts at 30 ma; 67 1/2 volts at 8 ma; 1.5 filament or 6.3 heater, bias, and microphone voltages. Completely filtered—neon tube voltage regulator—remote load-start relay—ruggedly made for dependable Navy use, 1 1/2" x 3 1/2" x 4". Weighs only 2 lbs. 1 Works on any 6 volt DC source.

Complete vibrator pack, less only battery (use car battery, etc.)\$3.95

With a clip-in RECHARGEABLE With TWO clip-in BLE Willard Storage Battery, Willard Primary Unbreakable, NON- \$5.50 batteries. (See our SPILL, plastic case \$5.50 ad.) Dec. QST ad.)

MAIL ORDERS? Certainly! Just list everything you want (items in this ad, or any ad, magazine, or catalog) and include remittance. Prompt shipment.

Vy 73 de
Bill Harrison, W2AVA

SUCCESSFUL SERVICE SHOP

(Continued from page 21)

condition of our operating capital. The books are completely balanced each evening, showing the total cash on hand and the bank account. We use an eight-column ledger and the disbursements are broken down into classifications corresponding to federal income tax returns. This in itself saves lots of time.

The income portion of the ledger is classified as Merchandise, Labor, and Miscellaneous. The miscellaneous column covers all non-profit returns to capital account (such as withholding tax and social security) and special discounts on items purchased. We find our books as important and useful in making the shop pay as any instrument on the bench.

We watch our inventory very closely—not only from a dollar standpoint, but each individual item. Through the use of our inventory card, a sample of which is reproduced here, we are able to determine how each item is turning over. We attempt to turn our dollar inventory four times a year, and our inventory system is an investment that pays for itself in culling out slow-moving lines of stock.

A local jobber supplies us with the greater part of our needs, but hardly a week goes by that we do not have a jobbers' representative from one of the larger trade centers asking us to consider their line. We certainly have had no trouble obtaining merchandise. I firmly believe, as Mr. Gernsback points out in his editorial, that if the distributor can better himself by giving you critical supplies, he is more than willing to do so.

HAM HEADQUARTERS
Since 1925!

HARRISON RADIO CORPORATION
9 WEST BROADWAY • NEW YORK CITY 7
PHONE—Barclay 7-9854 • EXPORT DEPT.—CABEE—"HARRISONRAD"
[JAMAICA BRANCH—172-31 Hillside Ave.—REpublic 9-4102]

ARMY-NAVY HEAD PHONES
\$2.49



FREE-Catalog

B.A. made a lucky buy. Genuine U. S. Signal Corps head phones, 8000 highly sensitive, bi-ohms impedance, only polar magnets. Only \$2.49 a pair plus 20c postage and pkg. chgs. Retail value \$13.50. Order No. 17A37.

GET THIS catalog, latest developments in radio and electronic parts and devices, newest ham gear, gadgets and bargains.



Do you need BINDING POSTS?

The XL PUSH POST with its Spring Action assures Constant Contact and Quick connection.

Manufactured in All Aluminum Type M at 12c each.

Aluminum Body, Bakelite Top Type B1 at 15c each.

Types CP or NP. ALL BRASS—STAIN-LESS STEEL SPRING & PIN. PROVEN by 240 HR. SALT SPRAY TEST as NON-CORROSIVE at 28c each.

Manufacturers and Dealers Liberal Discounts

X. L. RADIO LABORATORIES
420 West Chicago Ave., Chicago 10, Ill.

RADIO TUBES

Most Critical Types in Stock 50L6, 1A7, 35Z5, etc. Brand New, in Sealed Cartons

100% GUARANTEED

Repairmen and Dealers, Write For Available List at Trade Discounts

RADIO-EXPERTS
178 E. 33rd St., Dept. C, Paterson 4, N. J.

I'd like to show you how I've sold my unpatented inventions. George Pearce, 47J Bartholomew St., Peabody, Mass.

If five thousand people in America will benefit from your invention, you can sell it within sixty days.

GEORGE W. PEARCE, JR.
47 Bartholomew St. Peabody, Mass.

PEN-OSCIL-LITE

Extremely convenient test oscillator for all radio servicing: alignment • Small as a pen • Self powered • Range from 700 cycles audio to over 600 megacycles u.h.f. • Output from zero to 125 v. • Low in cost • Used by Signal Corps • Write for information.

GENERAL TEST EQUIPMENT
38 Argyle Ave. Buffalo 9, N. Y.

BURSTEIN-APPLEBEE CO.,
1012 McGee St., Kansas City 6, Mo.

Send me your new FREE catalog.

Send me _____ pairs of phones at \$2.49 plus 20c pair postage. I enclose \$ _____ in payment. RC

NAME _____

ADDRESS _____

TOWN _____ STATE _____



Large Vacuum-Packed Tin of Delicious PLANTERS PEANUTS ABSOLUTELY FREE!

Olson's New "Gift-of-the-Month"



The treat's on Olson—and what a treat! A big Half-Pound Tin of Planters famous Jumbo Peanuts—fresh, plump and tender! It's FREE to Olson customers. Why not be an Olson customer and get our free gifts, as well as really good radio parts?

Just fill out and mail the coupon below, and you're a member of Olson's FREE Gift-of-the-Month Club. No dues, we pay the gift bill! No obligation. This month, a \$10 purchase brings you one half-pound tin of Planters Peanuts FREE; a \$20 purchase brings you TWO tins, etc.

If you do not have our latest Bargain Catalog, paste this coupon on a postcard and mail today!



RADIO WAREHOUSE, INC.

73 E. MILL ST., DEPT. 71, AKRON, OHIO

Please enroll me in Olson's Gift-of-the-Month Club and send me your catalog. If I order this month, I will receive free Planters Peanuts as offered above.

NAME _____

ADDRESS _____

CITY _____

STATE _____

WORKING ON 50 AND 420 MC

(Continued from page 58)

as r.f.c. 2, can be inserted in the filament lead. The 6J6 has a filament voltage of 6.3 (a.c. or d.c.) volts at 0.45 amp.

The antenna coupling loop, of No. 12 or 14 tinned (bare) wire, is about 2 inches long and 1/2-inch wide. It is mounted about 1/2-inch above the plate

pling between the antenna coupling coil and the plate lines may be varied by using the coupling device shown in Fig. 6-b. The exact length of the coupling device depends on whether the antenna loop is mounted on the lid of the brass box or whether it is on the side of the box itself.

When adjusting the oscillator, the plate voltage should be reduced and the d.c. plate current should not exceed 8.5 to 17 ma for each plate. The manufacturers do not recommend operation of the 6J6 with fixed bias.

This 6J6 circuit is interesting for the beginner for it is easy to build and its operation is easy to understand. The circuit is unique in that flat brass strap is used for the plate lines, the conventional shorting bar is eliminated, and a capacity load on the plate lines controls the frequency.

If you like to experiment, try changing the size of the grid loop, then the values of R1 and R2, and then the spacing between the plate lines, noting the changes in frequency range and power output. This is the best way to learn about u.h.f. Another item of interest is that when u.h.f. transmitters are operated in the home they tend to pick up and be modulated by 60-cycle commercial interference from the various electrical fixtures. Considerable filtering and shielding is required in v.h.f and u.h.f. circuits to eliminate this noise.

BRAND NEW RADIO KITS

Of Notable Quality & Value!



MODEL S-5S

This radio kit contains the following features: Improved superheterodyne circuit, built-in loop antenna, PM Alnico speaker, streamlined airplane dial, wide tuning range: 550Kc-1600Kc, 5 tubes (including rectifier), 115V, AC-DC, 12SK7 IF, 12SA7 converter, 12SQ7 Det. and 1st audio 50L6GT output and

35Z5GT rectifier. In bakelite cabinet, with new illustrated instruction sheet, showing simple, detailed, step-by-step diagrams. Comes complete and ready for assembly.

NOW AVAILABLE!

KIT MODEL S-6X, a 6-tube, 2-band receiver kit, equipped for either 110 or 220 volts; AC or DC. Covers the following ranges: 550Kc-1600Kc, 6-18 Mc. Furnished complete, and ready for assembly.

KIT MODEL R-3, a 3-tube receiver kit of the regenerative type. This receiver is the 110-volt type and operates at a frequency of 550 to 1500Kc by means of a 1 plug-in coil. Complete, ready for assembly.

KIT MODEL RP-55, a combination radio and phono kit. (5-tube superheterodyne radio), 5" Alnico V Speaker, Astatic L-72 pick-up, beautiful walnut finish cabinet, ready for assembly.

ALL KITS SUPPLIED LESS WIRE & SOLDER
Write for Descriptive Catalog M

RADIO KITS COMPANY

120 Cedar St., New York 6, N. Y.

The North Atlantic Region of the Institute of Radio Engineers will hold a one-day Engineering Meeting May 3 in Cambridge, Mass. All persons interested in radio and electronics are invited to attend. Six technical sessions will be held.

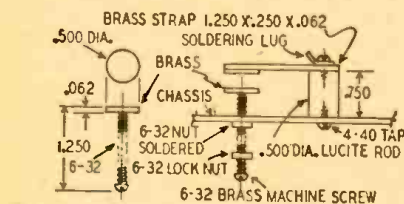

Fig. 6-a—Construction of antenna condenser.

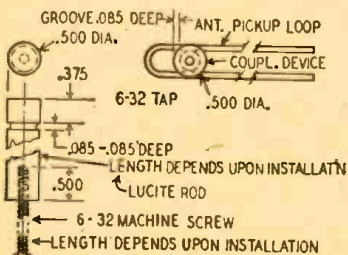

Fig. 6-b—Detail of antenna coupling loop lines. One side may terminate in a homemade padding condenser (Fig. 6-a). The other side is fed through a single-conductor AN connector and 52- or 72-ohm coaxial cable to a suitable dipole antenna. If desired, the cou-

Thousands of Satisfied Users!



TRANSVISION

TELEVISION KIT...A HIGH QUALITY TELEVISION RECEIVER

ready for Easy, Rapid Assembly

ENGINEERED BY TELEVISION SPECIALISTS



Easy-to-Assemble: No knowledge of television required. COMPLETE easy-to-follow INSTRUCTION SHEET gives you all the knowledge you need.

This Kit INCLUDES SOUND, all component parts, and the following:—

1. Specially designed Television Antenna.
2. A \$30.00 Lectrovision seven-inch Picture Tube . . . plus ALL other tubes.
3. Pre-tuned R-F unit.
4. Finished front panel.
5. All solder, wire and 60 feet of low loss lead-in cable.

Operates on 110V.; 50-60 cycles A.C.
 Price: complete with ALL tubes, \$159.50. Shipment will be made approximately 2 weeks after receipt of order. \$25.00 deposit required on all orders, balance C.O.D.

Trade Inquiries Invited

We believe that the comparative quality of this set is superior to other available sets. It has been acclaimed by major television schools throughout the country. For full information write to:

TRANSVISION, INC. DEPT. R. C.
 385 North Ave. New Rochelle, N. Y.
 Enclosed find \$..... deposit. Please ship
 Transvision Television Kits C.O.D. to
 Name
 Address
 City & State

EQUIPPING THE SHOP
 (Continued from page 27)

manuals available at a reasonable cost; they may be purchased from firms specializing in selling service manuals, the advertisements of these firms appearing in radio servicing magazines. Some radio schools offer a diagram service to students.

Many people think radio is very difficult. They ask, "I've no mechanical ability beyond handling a screwdriver and pliers; can I learn radio?" In practically all cases the answer is yes. Enroll with a good radio school. That is the most efficient way of getting started. Some individuals can learn by self-study, but a great amount of time is required. Some such individuals—of unusual ability—may become better radiomen than the average product of radio schools, others less brilliant, will not be thoroughly trained. For the average person, radio school training is essential. Even radio amateurs can benefit by taking a radio course, and thereby secure greater enjoyment from a fascinating hobby.

On the lips of many people today is the question, "Will there be job opportunities in radio?" In a word: "YES!" Opportunities in this field were never greater; for engineers, for servicemen, all interested in maintaining, designing, repairing all sorts of radio receiving, radio transmitting and electronic equipment. War-born radar has opened up new fields for employment in manufacturing, distribution and maintenance. This is definitely a radio-electronic age. Aviation and marine (ship) radar and standard radio applications will mean many jobs. To many, servicing work in any of these fields will be very attractive.

ANTENNA PRINCIPLES
 (Continued from page 31)

mission line since the ends have opposite r.f. polarity at any instant. The difference of potential between the opposite edges of the slot is greater than it is between top and bottom of the cylinder, therefore the tendency is for electrons to travel around the loops rather than up and down. Because of the opening in the cylinder the field pattern is not truly circular. Slightly greater radiation takes place in the direction of the slot.

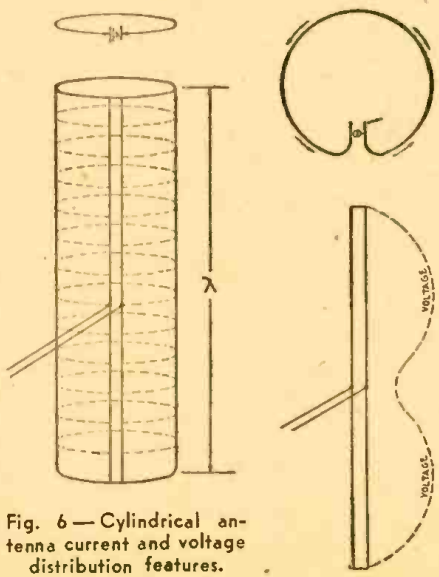
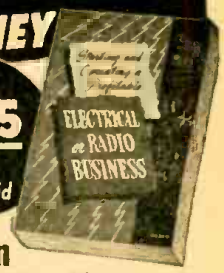

Fig. 6—Cylindrical antenna current and voltage distribution features.

Start Your Own Service Shop WITH LITTLE MONEY

NEW BOOK TELLS YOU HOW
 Only \$1.75 Postpaid



New 1947 Edition

Here are full facts about starting with small capital full or part time. Tells how to finance a business, select location and lay out store, buying and what to charge, advertising, salesmanship, record keeping, etc. Information you need to run a good paying shop of your own.
Send Coupon for 10 Days' FREE TRIAL
 Get this sensational new book, "Starting & Operating a Profitable Electrical or Radio Shop" on 10 days' Free Trial. 240 pages, only \$1.75 postpaid. Use coupon now.

RUSH THIS 10 DAY FREE TRIAL COUPON
 TECHNICAL BOOK DIVISION
 COYNE ELECTRICAL SCHOOL, Dept. 37-T1
 500 S. PAULINA ST., CHICAGO 12, ILL.
 O. K.—rush my copy of "Starting and Operating a Profitable Electrical or Radio Shop." I am enclosing \$1.75 remittance (Coyne pays postage). I understand I may return book in 10 days for full refund if I'm not entirely pleased.
 NAME..... AGE.....
 ADDRESS..... ZONE.....
 CITY..... STATE.....
 Check here if you prefer to have book sent C. O. D. Pay postman \$1.75 plus small C.O.D. fee upon delivery. Same 10 DAY SATISFACTION GUARANTEE.

The HOUSE OF A MILLION RADIO PARTS

BARGAINS IN TUBES BRAND NEW INDIVIDUALLY BOXED

TYPE	List	\$1.80	Your Cost	\$.99
6F8G	..	1.80	..	.99
6G6	..	1.80	..	.99
6K6	..	1.35	..	.69
6SA7	..	1.50	..	.83
6SN7	..	1.80	..	.99
6SN7	..	1.80	..	.99
6Y6G	..	2.20	..	.99
12A6	..	2.65	..	1.40
12AH7	..	2.20	..	.99
12C8	..	2.65	..	1.40
12SB7	..	1.80	..	.99
12SH7	..	1.80	..	.99
12SL7	..	2.20	..	1.09
12SN7	..	1.80	..	.99
12SR7	..	1.80	..	.99
39/44	..	1.35	..	.69
46	..	1.50	..	.78
53	..	2.20	..	1.23

Thousands of other tubes and radio supplies on hand. Write for bulletin No. 27.
Lifetime Sound Equipment Co.
 911 JEFFERSON AVE. TOLEDO 2, OHIO

Get Started in Radio

10 "HOW-TO-DO-IT" BOOKS

Get a solid foundation in radio by means of these 10c timely text books. Each clearly written, profusely illustrated, contains over 15,000 words. You'll be amazed at the wealth of information packed into these handy books. Excellent for reference—ideal for technical library. Your money back if not satisfied.

5 BOOKS for 50c
10 BOOKS for \$1.00

Sent to You Postpaid

No. 1—How To Make Four Doeric Short Wave Sets	No. 6—How To Have Fun With Radio
No. 2—How To Make The Most Popular All-Wave 1 and 2 Tube Receivers	No. 7—How To Read Radio Diagrams
No. 3—Alternating Current for Beginners	No. 8—Radio for Beginners
No. 4—All About Aerials	No. 9—Simple Electrical Experiments
No. 5—Beginners' Radio Dictionary	No. 10—Television

Remit by check or money order—register letter if you send cash or stamps.
 RADIO PUBLICATIONS, 25A West 87way, New York (7)

Television service for 32.8 percent of the population of the United States is already assured by construction permits or licenses granted to 57 prospective stations in 30 metropolitan districts.

LEEDS

FREE and RATE GYRO

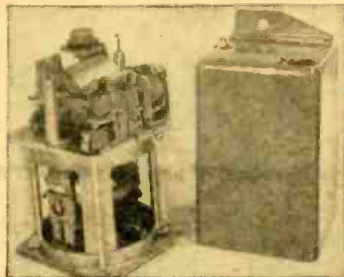

Schwein 24 Volt Gyro. **\$5.00**
Complete in case,

METERS

0-1ma McClintock 2" Bakelite\$2.95
0-3ma Gruen 2" Bakelite 1.95

4" x 4" x 2" Black Crackle Boxes35c
J-37 Key $\frac{3}{16}$ " contacts special 69c
Ohmite 25 ohm 50 watt adj. Resistor ...15c

**NATIONAL #686
VIBRATOR TYPE
POWER SUPPLY**
Input 6VDC, Output 165V 50 Ma.
For your Battery or Mobile Receiver
List price \$56.93
Your cost 9.95

NATIONAL RECEIVERS. HRO-5TA with Power Supply & 4 sets of coils (1.7-30mc) \$303.00
NC-240D with speaker \$241.44
NC-46 with speaker \$107.40

Circuit Breakers — Heineman 115VAC Magnetic available 5-7-20-35 amps. Each 95c

CONDENSERS

25mmfd APC Type Air Padders ... 25c
50mmfd or 75mmfd 35c
Aerovox 0.1mf-7500VDC oils\$1.50
.25mf 2000 VDC oils 25c
.5mf 1500 VDC oils 25c

Selsyns—115V AC 60 cycle Type 5 per pair **\$5.00**

115V AC 60 cycle type 11-1 in armored case with indicating scaleper pair **9.00**

ARMY MIKE & PHONES



Self Exciting Dynamic Mike and Phones for Batteryless Intercom or Recording. Complete Dynamic Hand Mike, 2 Headphones, Head Band and Cord Set. **\$3.45**
A tremendous value

If not rated 25% with order, balance C.O.D. All prices F.O.B. our warehouse New York. No order under \$2.00

We ship to any part of the globe

LEEDS RADIO CO.

75 Vesey St., Dept. 45
COntland 7-2612 New York City 7

THE 'SCOPE—A REPAIR TOOL

(Continued from page 56)

resonance, climbing up to a peak at resonance, and then falling off to practically zero above resonance, in one half cycle of the recurrence rate of 30 cycles. The next half cycle retraces the pattern with the frequency changing in reverse order. This double pattern remains stationary on the screen with the proper

First: The filtered d.c. pattern (test No. 3); Second: The amplified a.f. signal pattern (test No. 9); Third: The amplified and detected i.f. signal pattern (test No. 14); Fourth: The converted heterodyne signal pattern (test No. 15); and Fifth: The tuned and converted r.f. signal pattern (test No. 16);

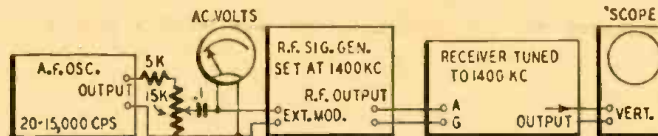

Fig. 2—The receiver can be checked for frequency characteristics with the set-up above.

synchronization. These off-resonance response characteristics are shown in Fig. 1, which is simplified by showing only the trace produced in one direction. The part marked "a" in this figure shows a representative *single-peaked* response; "b," an excessively sharply-peaked response; "c," a typical broad (or high-fidelity) response; and "d," an example of misalignment in the i.f. transformer.

Fidelity Response

A check on the fidelity of the entire receiver also can be made without a frequency-swept signal by the use of a variable-frequency audio oscillator to amplitude-modulate the generator signal (test No. 18). This can be done with most standard signal generators by connecting the measured output of the audio oscillator to the EXT. MOD. terminals of the signal generator, as shown in Fig. 2. By establishing a reference, around 400 or preferably 1,000 cycles, and noting the audio voltage produced by the signal generator, the frequency of the audio oscillator can now be run higher while maintaining the same voltage output by its attenuator. Experience with various sets will show the amount of falling-off at high frequencies to be expected from various types of sets.

Apart from the audio section, a common cause of poor high-frequency response is found in i.f. transformers that are peaked too sharply, cutting off part of the side bands of the high audio-frequency modulation. Such a fault,

and also additional optional tests on frequency-swept signal patterns (test No. 17), and variable-frequency, amplitude-modulated ones (test No. 18).

Of the many possible trouble indications encountered, aside from obvious nonoperation or too weak operation, the most common type of distortion is amplitude distortion (known also as harmonic distortion), which is illustrated in two forms in Fig. 3. Since its cause is some condition which results in the tube operating on a nonlinear portion of its characteristic curve, the trouble generally will be found to be an incorrect bias resistor (that may have changed in value with time), or to a tube being overdriven by an excessive signal (even though correctly biased), or some similar condition. Fig. 3-a illustrates a mild distortion, consisting mostly of a third harmonic component, that might have been introduced by slightly incorrect bias; Fig. 3-b shows an extreme condition in which the input signal overdrives the tube or a leaking coupling condenser upsets normal operation.

QUAINT SERVICE CUSTOMS

Servicemen in some foreign lands run up against problems and conditions not dreamed of by the American repairman.

In China, if the radio owner is interested in both local and foreign programs, the serviceman may be in a quandary to assure proper tone quality, because Western programs sound best with the basses accentuated, while Chinese music must have the trebles brought out. Thus, the tone control is backed up as far as possible for Chinese programs, while for foreign music it is advanced toward the forward stop. Thus the serviceman is in wrong if the radio does not amplify well at both ends of the audio range.

In Ecuador the radioman enjoys a siesta every afternoon for a three-hour period. During that period of time he cannot be disturbed no matter how urgently a radio set owner desires his services. And every radio repairman automatically takes one week off every six months, during which, so far as he is concerned, his shop ceases to exist.



Fig. 3—Amplitude and harmonic distortion.

when not inherent in the design, can be easily located and remedied by the use of this method.





Summary:

This *quick check* method for localizing trouble calls for observing the following indications:

LEOTONE SURPLUS SPECIALS

AC-DC Shunt Wound Reversible Motor, 1/40 HP, 3800 RPM on either 27V. DC or 18V AC, 1.4 amps. cont. duty. 4 3/4" x 2 3/4" SHPK. wt. 3.54 lbs. POWER RHEOSTATS. HV duty. Standard brands. 25W-15, 25, 50, 100, 150, 250, 350, or 500 ohms. .59
SPECIAL III—50' 15' cas. alum. she. .59
cond. (221) transmission cable. Flexible twisted, stranded, lined. Red & black rubber insul. outside VINYLITE jacket. Suitable communication, P.A., or light electrical work. .03 per foot—250 ft. \$5.00
E-1 Transformer Laminations. Hi-grade silicon steel (0177) 5 1/2" x 4 1/4". Windows: 1 1/4" x 2 5/8". 30 E-1 laminations. \$1.80
4 TUBE AMPLIFIER (2-7C5, 7F7, 7Y4) Used as electronic supercharger control. 110V, 400 cycle. Contains: power trans., 7 condensers (mica & oil), 7 resistors, 4 loctal sockets plus other components worth several times the price. Black crackle finish case, fitted slide-in chassis. 8 3/4" x 4 1/2" x 3 3/4". Less tubes \$1.49

ALNICO MAGNETS

- #1  #2  #3  #4  #5 
- #1—Bar, 7"x1/4"x1/4" .39
- #2—Face in shorter lengths, per inch .12
- #3—Face 1 1/4"x1/4"x1/4" high .98
- #3—Heavy duty bar, 2 1/2"x1 3/4"x5/16" thick .98
- #4—Face 3/4"x3/4"x3/4" high .39
- #5—Polished, face 1/8"x3/4" high .35
- #6—Polished bar, 9/16"x1/4"x1/4", 20 for 1.00
- #7—Face 1 1/2"x3/4"x3/4" high .10
- #8—ALNICO V shoe, poles 3/4" sq., 1 1/4" high .75
- #9—ALNICO V shoe, poles 9/16" sq., 1 1/2" high .98
- #10—ALNICO V shoe, poles 1"x1 1/4"x2 3/4" high .95
- #11—Horseshoe ca. pole 1 1/16" O.D., 2 1/4" high .129
- #12—Similar to #5) 5/8"x3/4"x7/16" high .35
- #14—Polished hvy duty bar, 3"x1 1/4"x7/8" (magnetized lengthwise, wide or narrow sides) 1.29
- Giant Banana Plug & Jack, Hvy spring brass contact (3/4"x3/4") for hi-currents, 2 pair for SEISYN Synchro-transmitters, 115V, 60 cycle. Used in pairs as trans. & follower, 3 1/2"x5" ca. 3.75
- 15" N.B.C. RECORDINGS. For home, P.A. systems, demonstration, etc. Each contains 2 complete, different 15 min. "Voice of the Army" dramatic programs with music. Over 60 different titles, such as "Light in the West," "The Secret," "They Named a Ship," etc. 33 1/3 RPM. 5 ass't. Records. 3.65N7. 1.49
- 9 TUBE AMPLIFIER (Gendrix) 281E, 3.65N7. Orig. used with remote indicator. 27V. DC. 110V, 400 cycle. Black crackle, shock-mtd. case and fitted chassis. 7 3/4"x5 1/2"x4 1/2". Less tubes 2.49
- SPST Current Relay (Guardian) 2.5 amp. coil, 24V. DC. 3/4" silver contacts, norm. open 1.25
- 20mfd/200WV tubular electrolytics. 2 for 1.00
- BAKELITE PANELS: 1/4" glossy brown 7"x10" —59c. 7"x14" —69c. 7"x18" —79c. 9"x14" —85c
- EARPHONE HEADBANDS (HS-33) Leather covered, adjustable frame. Type and color selected & PL-54 .39
- PL-54 plug & 13' tipped double phone cord .19
- D.P.D.T. TOGGLE SWITCHES (HS-33) External lugs. 6A/125V. bakelite case. Split bar 39
- Frequency Meter Tech. Manual (Navy) Theory & operation. 36 illus. & diagrams. 59pp. .15
- "FMT" Tech. Manual (Army) Theory, construction & operation. 86 diagrams, 40 illustrations. 240 pp. .39
- CHASSIS & COVERS FOUNDATION. 3 tube punched steel chassis & cover. 11"x9 1/2"x4 1/4" Binding Posts (TM-175) Hvy duty plated brass. Needle contact, knurled head. O.D. 1/4". 3/4" high .100
- EXPERIMENTAL TUBES. 20 ass'd. sizes & base types for testing, research, etc. Fil. tested 1.00

SERVICEMEN'S KITS

- #1—R.F. Antenna & Os2. coils. 10 ass'd. .98
- #2—Speaker Cones. 12 sizes. 4 1/2" mounded & free-edge (magnetic incl.). Less voice coils 2.00
- #3—BAKELITE MICA CONDENSERS. 50 ass'd. 00001 to .2mfd, 200-600WV. Clearly marked 2.95
- #4—Tubular By-Pass Condensers. 50 ass'd. .001 to .25mfd, 200-600WV. Standard brands 2.49
- #6—Dial Scales: 25 ass'd. airplane & slide-rule (acetate & glass included) 2.98
- #7—Eucalypton Plates: 25 ass'd. airplane, slide-rule and full vision types 2.95
- #8—Knobs: 25 ass'd. wood & bakelite, incl. int. set screws & washers. 25 ass'd. cabinet ferrule-ended. 50,000 to 5 megohms .49
- RADIO HARDWARE TREASURE. Over 1000 screws, nuts, washers, lugs, etc. PLUS handy 30 compartment cardboard kit box. .59
- PROMPT SERVICE ON ALL SPEAKER & PHONO PICK-UP REPAIRS. Minimum order \$2.00—20% Deposit Required on all Orders

Please Add Sufficient Postage
WRITE DEPT. RC.3

LEOTONE RADIO CO.
MAKERS OF CONES AND FIELD COILS
65-67 DEY STREET, NEW YORK 7, N.Y.
WORTH 2-0284-5
12,000 SQ. FT. OF RADIO PARTS

BUILDING A TELEVISER

(Continued from page 32)

ation of the installation will determine, to a large extent, the selection of a suitable antenna. In suburban areas, antennas such as those shown in Photo A

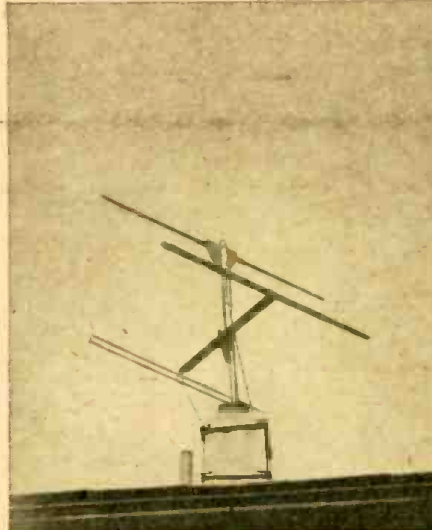

Photo A—The author's own television antenna.

may be used with satisfactory results. The top antenna is a dipole made of 1 1/2-inch aluminum tubing and is connected to the receiver with 72-ohm coaxial transmission line. This antenna is cut for 60 mc and was used for receiving old Channels 1 and 2. It is satisfactory for the present Channels 2 and 3. The bottom antenna, used for receiving Channels 4 and 5, is a folded dipole made of 1/2-inch aluminum tubing and connected to the receiver through 300-ohm twin-lead transmission line. This antenna is cut for approximately 76 mc. Where the receiver is located in city areas it may be necessary to place reflectors behind the antennas to reduce ghosts due to signal reflections from buildings. Television signals are received along a line-of-sight path from the transmitter; therefore, any tall objects in this path should be avoided as they will absorb and reflect the signal. The receiver described here is used approximately 25 air-line miles from New York City and gives more than sufficient signal strength, although the antennas are only 25 feet above the ground. Each installation will be an individual case and the antenna should be adjusted in height and direction to give the best picture. Wide-band-type antennas should be used to give the best results. More details about the selection and installation of antennas can be found in any standard radio handbook and in the series of articles currently appearing in RADIO-CRAFT.

After the set is completed, it can be built into any type of cabinet that suits the decorative scheme of the home. The cabinet used by the writer houses the televiser as well as a phonograph and amplifier and an all-wave receiver. This televiser has been in service for two years and has given very little trouble.

Do YOU Own a BC-312 RECEIVER?

Convert to AC Operation with

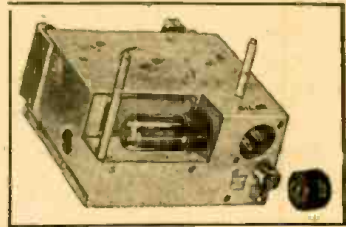

the RA-20 Power Pack

Eliminate batteries, and makeshift messy power supplies. RA-20 Power pack fits right into dynamotor compartment! Takes just FIVE MINUTES to install.

Can also be used with many other similar receivers and equipment designed for dynamotor or battery operation.
PRIMARY: 110-120 volts 60 cycles AC.
SECONDARY: delivers 250 volts DC at 95 mls. 12 volts at 3 amps. 12 volts CT at 2. amps.
RA-20 Price, Brand New. Complete with rectifier tube and plug **\$9.95**

Write DEPARTMENT 27-C

Federated Purchaser

INCORPORATED
distributors of RADIO-ELECTRONIC and SOUND EQUIPMENT
80 PARK PLACE, N. Y. 7
Phone: WH 4-2080

S.S.S.

"Servicing by Signal Substitution"

Learn about this modern-dynamic approach to radio servicing with ONLY BASIC TEST EQUIPMENT.

... Fully described in a 120 page book available from your Precision Distributor or factory at 35c.

... Schools are invited to inquire regarding quantity orders from our Educational Division.

PRECISION APPARATUS COMPANY INC.

ELMHURST 4, N. Y.
Manufacturers of Fine Test Equipment
RADIO • TELEVISION • ELECTRICAL • LABORATORY

ROTA-BASE

NEW HANDY LAB. DIAL. Simply turn the movable dial to the tube number desired on the ROTA-BASE and complete correct connections are instantly indicated on the "prong" diagram. Filament, grid, plate, cathode, etc., to more than 300 tube types are given. No more valuable time lost on lengthy reading or turning of pages. ROTA-BASE actually gives a "prong" picture of the connections. PRICE NOW ONLY \$1.00. Postage prepaid or sent C.O.D. plus postmark. Money back if not delightfully pleased.
REED MFG. CO. 411 S. Main St. Los Angeles, Calif.

RADIO BOOKS BY MAIL

OVER 125 TITLES IN STOCK

SAME-DAY SHIPMENT ON 98% OF ALL MAIL ORDERS. Books of nearly all radio publishers. If you don't know price, send deposit and we'll ship C.O.D.

SEND STAMP FOR CATALOG TO EDITORS AND ENGINEERS, Ltd. 1305 Kenwood Road • Santa Barbara, California

WILCOX CW 3 RECEIVER



The CW Receiver is a highly selective crystal controlled superheterodyne unit operating of any fixed frequency in the band of 1900 kc to 16,500 kc. The total band is covered by means of four groups of plug-in coils. Extension of the range above or below the specified range may be had by means of special groups of plug-in coils. Plug connections are provided for 110 volt, 60 cycle AC power source and for connection of receiver output.

- ★ FIXED FREQUENCY RECEIVER
- ★ 7 TUBE SUPERHET CIRCUIT
- ★ CRYSTAL CONTROLLED LOCAL OSCILLATOR
- ★ COILS SUPPLIED COVER 5.6 TO 10 MEGACYCLE BAND
- ★ AUDIO AMPLIFIER STAGE CAPABLE OF PRODUCING ZERO LEVEL DB OUTPUT ACROSS A 500 OHM LOAD
- ★ TUBE COMPLEMENT
 - 2-6K7
 - 1-6K8
 - 2-6C8G
 - 1-6SN7
 - 1-80
- ★ COMPLETE SET OF EXTRA SPARE TUBES
- ★ FITS STANDARD 19" RACK, 19" WIDE, 3 1/2" HIGH, 11 1/2" DEEP
- ★ GRAY & BLACK FINISH
- ★ PACKED IN WOODEN SHIPPING CASE
- ★ WEIGHT ONLY 14 LBS. NET
- ★ SHIPPING WEIGHT 42 LBS.
- ★ COMPLETE WITH INSTRUCTION BOOK, COILS, LESS CRYSTAL

ONLY \$21⁹⁵

F.O.B., N.Y.

25% deposit required
on C.O.D. shipments

MARITIME SWITCHBOARD

336 CANAL STREET NEW YORK 13, N. Y.

SWITCHING AND TRIGGERING

(Continued from page 23)

thermometers constantly and regulate the heat supply and prevent temperature variations become unnecessary. One man can oversee many automatic controls.

For example, a heat chamber requires that a constant temperature be maintained at all times within it. To achieve this stability, a mercury thermometer may be installed in the chamber. A small source of light is focused through the thermometer on a phototube. A heater controls the temperature of the chamber, and is turned on and off by means of a relay actuated by an electronic switch.

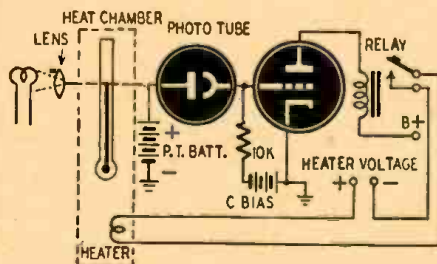

Fig. 3—Temperature control with phototube.

Operation of this circuit (Fig. 3) is similar to that of preceding switch circuit.

When the mercury in the thermometer falls below a certain required level, light strikes the phototube, causing it to conduct. Resultant current passing through the grid resistor provides sufficient grid voltage for the triode to conduct. Plate current flows, and the relay is energized, turning on the heater to provide additional heat in the chamber. As heat increases, the col-

umn of mercury rises until it intercepts the light beam. This stops photoemission, and permits the grid voltage of the triode to return to its fixed negative value—preventing conduction. Interruption of current through the relay coil turns off the heater in the chamber, until such time as the mercury in the thermometer drops below the critical value.

In similar ways, phototubes can be used to control illumination and determine smoke density. They can also be used to stop machinery when the product is imperfect. Phototube switch circuits are also frequently employed as safety devices—protecting workers engaged in dangerous phases of manufacture or production.

One such protective device is an electronic switch developed and used by RCA, which provides an invisible guardrail of infra-red light between die presses and workers' fingers (Photo A). Two small mirrors reflect a beam of infra-red light across the front of the die press and back to a phototube—the input of the electronic switch. Any interruption of the beam trips controlling relays and locks the powerful press with dies open.

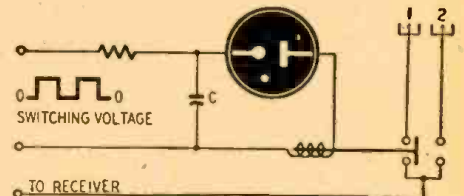

Fig. 4—A switching circuit using gas diode.



Photo A—Phototube-operated electronic safety switch. Interrupting beam locks die open.

Courtesy RCA

Gas-Filled Tubes

Gas-filled tubes—both diodes and triodes—are extremely useful for high-speed switching, because of their low internal resistance and their unusual conducting properties.

When such a tube is not conducting, the resistance across the device is very high. However, as the plate voltage is increased, the gas ionizes at the instant the plate voltage passes a given critical value. Current then flows through the tube and related circuit, until such time as the plate voltage is decreased and reaches a second critical value—at which time the gas becomes de-ionized and the tube ceases to conduct.

Introduction of a grid provides greater control of the tube's operation, but doesn't disturb above general function.

A simple relay switching circuit (Fig. 4) illustrates the action of a gas-filled diode. In this arrangement, either of two antennas can be connected to a single radio receiver—and it's desired to switch between them alternately at a very high speed. When the switching circuit is not in operation, a tension spring on the relay connects the arm to antenna 1. Application of a control impulse charges condenser C (Fig. 4), applying a positive potential to the plate of the gas-filled diode. When this potential reaches the critical voltage of the tube, the diode suddenly conducts. Resultant heavy current operates the relay arm, moving it instantly from antenna 1 to antenna 2. When the trailing edge of the control impulse suddenly reduces the voltage on the tube to zero (or a minimum value), the condenser C is discharged. Plate voltage is removed, the diode ceases to conduct, and the de-

energized relay arm springs back to its original position.

Switching action is wholly dependent upon the control impulse. Thus, a series of pulses recurring at a high frequency would cause the two antennas to feed alternately into the receiver at that rate. Details of damping, etc., to prevent switch clicks have been omitted. But the variety of uses of such an arrangement are immediately apparent.

Precision Switching

Requirements of some types of precision switching circuits demand that the output impulses have very steep sides and sharp corners, be of extremely brief duration, and have sufficient voltage (or current) amplitude to activate the actual switch device.

Formation of pulses having such form and dimensions can be easily accomplished by pulse-forming stages contained in the complete electronic switch. Although the number and arrangement of such stages is almost limitless, individual functions of the stages in a control circuit are basically simple. Fig. 5 illustrates this simplicity.

As an industrial example, assume that the feed line for a high-speed automatic stapling machine must be regulated so that the machine functions at maximum efficiency. Staples fed to the machine 600 times per minute—or 10 per second—will do the trick. The feed line is controlled by an on-off low-capacity relay, which is actuated at the desired rate of 10 times per second. Direct actuation of the relay is accomplished by means of a series of recurrent, properly shaped pulses—produced

(Continued on page 72)

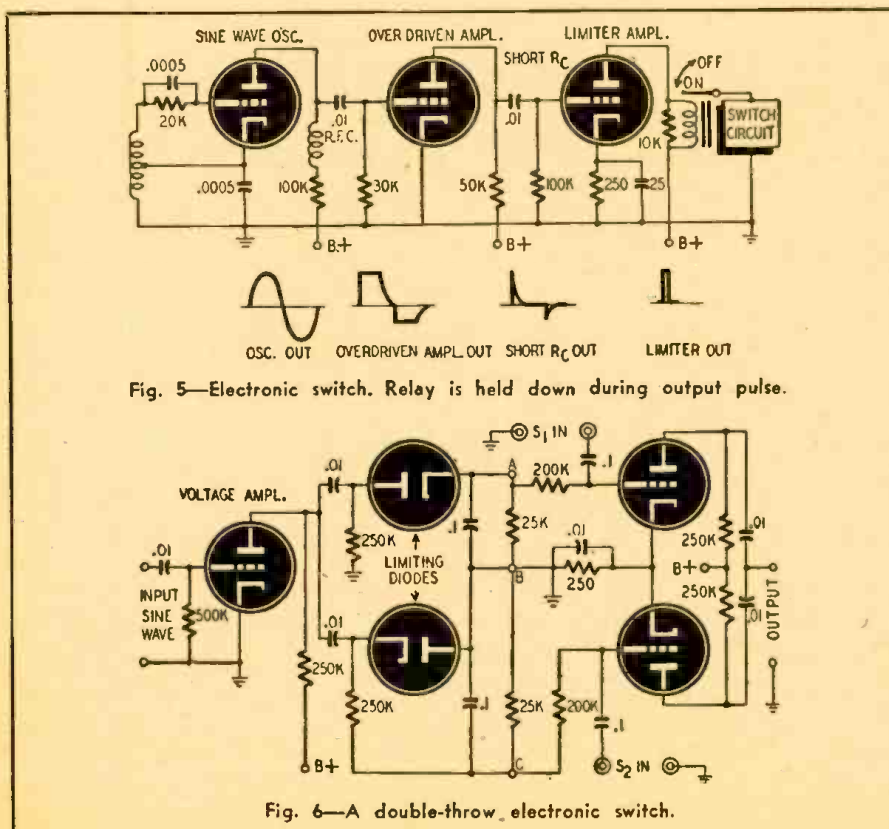

Fig. 5—Electronic switch. Relay is held down during output pulse.

Fig. 6—A double-throw electronic switch.

METERS

SPECIAL OFFER

**SURPLUS—NEW
GUARANTEED**

D. C. MILLIAMMETERS

3 Matching Simpson Meters, 3 1/2", round, flush, bakelite cases, 0-15 MA, 0-100 MA, 0-200 MA. Excellent for "ham" rigs. Your cost for these 3 meters, postage paid anywhere in U.S. or Canada,

ONLY \$9⁹⁵

A. C. VOLTMETER, A. C. AMMETER, and D. C. AMMETER

3 Triplett Meters, 3 1/2", round, flush, bakelite cases, 0-150 volt A.C., 0-75 Amperes A.C. and 0-15 Amperes D.C. Your cost for these 3 meters, postage paid anywhere in U.S. or Canada,

ONLY \$8⁹⁵

A. C. VOLTMETER and A. C. AMMETER

2 Matching 3 1/2", G.E. round, flush, bakelite, cases, 0-150 volt and 0-80 Amperes. Your cost for these 2 meters, postage paid anywhere in U.S. or Canada,

ONLY \$7⁹⁵

A. C. VOLTMETER

Hickok Aircraft Meter, flush, round, bakelite case, 2 1/2", 0-150 volt A.C. Black scale, luminous markings suitable for use from 25 to 125 cycles.

R. F. AMMETER

Simpson 2 1/2", round, flush, bakelite case, 0-3 Amperes Radio Frequency White Scale.

D. C. MILLIAMMETER

G.E., DW-41, 2 1/2" round, flush, bakelite case, 0-1 MA mvt. Special scale marked 0-500 MA and 0-140 D.C. Volts-MA. Complete with paper V-O-MA scale.

D. C. MILLIAMMETER

Gruen, 2 1/2", round, flush, bakelite case, 0-3 MA, white scale.

D. C.-A. C. VOLTMETER

Sterling, 2", ring mounting, stamped metal case, polarized vane type, 0-250 volts. Direct Current and Alternating Current, 5% Accuracy.

RECTIFIER TYPE MICROAMMETER

Hickok, 2 1/2", round, ring mounted, metal case, 0-700 microamperes D.C. Full scale, 0-100 microamperes D.C. Half scale, 0-1 M.A. A.C. Full scale. Complete with self contained half wave rectifier. Black scale, luminous markings, scale 0-10. Your cost for these 6 Meters, postage paid anywhere in U.S., or Canada,

ONLY \$9⁹⁵

MARITIME SWITCHBOARD

336 Canal Street
NEW YORK 13, N. Y.

SURPLUS SURPLUS SURPLUS

RADIO TRANSMITTER

BC 1306, complete with two tubes, 2E22 and VR 105 uses two 3A4's that are missing **\$6.00**

MINE DETECTOR

Complete with tubes new **\$9.95**

NAVY INTERPHONE AMPLIFIER

Type R-7, complete with tubes less dynamotor (dynamotor 75c extra) **\$2.00**

KEYER

TG-10, with photoelectric cell, has complete 20 watt amplifier, also 1/20 horsepower, 60 cycle AC motor enclosed in black crackle case 15" x 21" x 10 1/2". 110 volt, 60 cycle using a pair 6L6's in the output (less tubes) **\$15.00**

POWER TRANS

100 mill 2-6.3 5V 700 ct 60 cy—110V **\$1.25**

RESISTORS

(assorted) Per thousand **\$7.50**

No order accepted less than \$5.00

Thousands of parts and tubes in stock. Tell us your needs.

Send check, money order or merely enclose currency (at your risk)

RADIO CENTER

5834 WEST WARREN AVENUE
Phone TYler 7-2720 and 7-5878
DETROIT 10, MICHIGAN

2530 EAST DAVISON
Phone TUlsa 3-0355
DETROIT 12, MICHIGAN

SWITCHING and TRIGGERING

(Continued from page 71)

by an electronic switch *without* exterior control.

The rate of pulse repetition is the *pulse recurrence frequency*. This is the same as the *resonant frequency* of the audio oscillator located in the first stage of the switching circuit (Fig. 5).

Output of the oscillator is applied to pulse-forming stages which reshape the oscillations—and produce a series of recurrent pulses having the desired amplitude and duration. Exact shape of the voltage (or current) pulses will depend upon the input requirements of the relay or other electro-mechanical device being actuated.

Other Switches

One popular type of electronic switch uses a pair of triode or multigrid vacuum tubes to switch alternately between two input signals providing a consolidated output. The rate of switching between the two input signals is determined by a square-wave control voltage derived from a sine wave of known frequency. The complete circuit of the switch (Fig. 6) consists of a straight triode amplifier, two diodes providing positive and negative limiting of the controlling sine wave, and the two control tubes. These two tubes constitute the electronic switching action. Each tube is biased just beyond cutoff, and each tube receives one of the input signals.

After amplification by the triode, the input (control) sine wave is clipped and squared by the two limiting diodes. A positive half-cycle square wave appears between circuit points A and B (Fig.

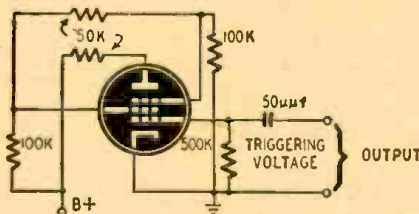

Fig. 7—Triggering circuit with pentode tube.

6), and a negative half-cycle square wave between B and C. Both of the switching tubes are biased just beyond cutoff. But the positive voltage—between points A and B—makes switching tube 1 conductive, and input signal S1 passes through tube 1 into the output of the control circuit. Switching tube 2 does not function, and input signal S2 is not passed into the output.

When the input (control) sine wave changes polarity and the half-cycle square waves—the limiter outputs—also change polarity, the condition is reversed. Positive voltage between points B and C make switching tube 2 conductive, and signal S2 passes through the tube into the output. Since tube 1 is not conducting during this half cycle, it effectively blocks signal S1.

Thus the two input signals—S1 and S2—appear alternately in the output of the switching circuit at a rate of re-

REAL SAVINGS IMMEDIATE DELIVERY

SPEAKERS

5" P.M. ALNICO 5 MAGNET **\$1.39**

6 for \$8.00

4" Alnico 5 Magnet \$1.95
6" PM 2.15 oz. Alnico 5 Magnet 2.39
8" PM 20 oz Slug 4.95
12" PM 20 oz Slug 8.95

VOLUME CONTROLS

1/2 MEG with switch and 2" shaft **75c**

6 for \$4.25

Kit of 10 assorted controls, without switch \$1.95

WIRE

Approximately 400 ft. of wire in assorted colors and gauges, solid and stranded in 2 to 4 feet lengths, per Pkg. **\$.99**

2 pkgs. for \$1.90

No. 20 shielded wire, stranded, per ft. \$.03
Radio gauge spaghetti, per ft.01
No. 20 solid pushback, per foot01

TRANSFORMERS

70 MIL POWER TRANSFORMER 600 V 6.3V @ 3 Amp. C.T., 5V @ 3 Amp. **\$2.95**

3 for \$8.00

50 Mil Power 500V, 6.3V @ 2 Amp, 5V @ 2 Amp \$1.95
50L6 Output59
6V6 Output69
4 Watt Universal Output 1.09
8 Watt Universal Output 1.29

STANDARD 4 PRONG UNIVERSAL REPLACEMENT NON-SYNCHRONOUS VIBRATOR, each. **\$1.39**

CONDENSERS TUBULAR PAPER CONDENSERS

All 600 Volt test

MFD.	PRICE EACH	PRICE PER 100	MFD.	PRICE EACH	PRICE PER 100
.01	.08	\$6.50	.001	.08	\$6.50
.02	.08	6.50	.002	.08	6.50
.05	.10	8.00	.005	.08	6.50
.1	.12	9.00	.006	.08	6.50
.25	.17	13.50	.5	.28	22.50

"ILLINOIS" ELECTROLYTICS

MFD.	VDC.	PRICE	MFD.	VDC.	PRICE
10	25v	.25	50	150v	.50
100	25v	.55	8	450v	.38
12	50v	.38	10	450v	.43
16	150v	.35	16	450v	.55
20	150v	.38	20	450v	.60
24	150v	.38	40	450v	.88
30	150v	.40	100	15v	.49

"ILLINOIS" DUALS

16-16	150v	.58	50-30	150v	.70
20-20	150v	.65	8-8	450v	.65
30-30	150v	.70	10-10	450v	.70
40-20	150v	.70	20-20-20	150v	.99

10% discount on all electrolytics if purchased in lots of 10 or more.
Mica Condensers, all sizes, 8c each

RESISTOR & MICA KITS

Resistor kit of 100 insulated resistors in popular values of 1/4, 1/2, 1 and 2 watt. \$1.95
Mica Condenser kit of 30 Micas in popular values, .01, .0001, .0002, etc. 2.00

12 lbs. SURPLUS RADIO PARTS **\$2.00**

A gold mine of parts for repairmen, amateurs and experimenters. sockets, condensers, resistors, transformers, coils, hardware, wire, etc. An outstanding bargain in usable parts! Send \$2.00 cash, check or M.O. today! (Pay small express charges on receipt.)

All items subject to prior sale

20% with order, balance C.O.D. We prepay express on \$50.00 orders in U.S.A. Write for Catalog.

ELECTRONIC PARTS, Inc., Dept. C3
622 W. Randolph St. Chicago 6, Ill.

WAR SURPLUS SALES

RADIO - ELECTRICAL - ELECTRONIC EQUIPMENT - PARTS - SUPPLIES

SUPERIOR 2 KVA Powerstats; input 115 volts 50-60 cycle—output voltage range 0-135 volts; maximum rated output current 15 amp. available over entire range of output voltage; weighs approx. 20 lbs. **29.50**

ZENITH, BENDIX or PHILCO frequency meters, 125 to 20,000 KC, type BC-221 with original crystals; complete with spare tubes and calibration book, each one is tested and guaranteed **54.50**

P. M. SPEAKER 5" remote control unit, 3" dia. 1 1/2" high slug; complete in metal case with volume control, receiver, phone and transmitter on and off switches, phone and microphone jacks, output transformer; each **3.50**

STANDARD RACK CABINETS of heavy gauge steel with grey crackle finish; panel opening 19" W., 27" H., 15 1/2" D. **12.95**

WESTERN ELECTRIC or SYLVANIA types 1N21 & 1N23 Crystals; 35c each or 3 for **1.00**

HIPOWER quartz Crystal units, type CF5, 5000 KC complete with holder **1.95**

GENERAL ELECTRIC 0-1 amp. RF METERS. Model 8DW44, 2" scale, in bakelite case **2.50**

WESTINGHOUSE 0-10 volts, AC-DC, voltmeter type NA-33 2" scale, bakelite case **2.50**

STANDOFF CERAMIC INSULATORS 5" high, brass oval base, round brass top; complete with clamp. Original cost \$2.00. Special **.29**

25% deposit required on C.O.D. Orders
All merchandise shipped F.O.B. New York

MICHAEL STAHL, INC.
39 VESEY ST.
Tel. Cortland 7-5980 New York 7, N. Y.

Come to the famous
COYNE
TRAINING SHOPS
where you learn by doing



TRAIN FOR **RADIO-ELECTRONICS** IN A FEW WEEKS

Prepare For A Good Job Now With A Lifetime Future!

Trained Radio-Electronics men needed now. They will be needed too in the years to come. Don't be caught napping. Get a Radio training now and be ready. Learn by Doing. Free employment service for life after graduation. Many earn while learning. If you are short of money, ask about my Student Finance Plan. Now added Training in Industrial Electronics and Electric Refrigeration. We are also equipped to train those who qualify under G. I. Bill. We also have facilities for men with physical disabilities whether due to war or other causes. Fill in and mail coupon for details.

SEND COUPON FOR FULL DETAILS

B. W. COOKE, Dir., Radio-Electronics Div.
COYNE ELECTRICAL SCHOOL
500 S. Paulina St., Dept. 37-8H, Chicago 12, Ill.
Send Big Free Book; also details about Coyne Part-Time Employment and Student Finance Plan.
 Send G. I. Bulletin Physical Disability

NAME..... AGE.....
ADDRESS.....
CITY..... STATE.....

current determined entirely by the frequency of the input (control) sine wave of voltage.

Typical commercial model of an electronic switch (Photo B) is the General Electric type YE-9 for comparative studies of wave-form phases, frequency relationships, and amplitudes of any two input signals. Use of two such electronic switches in cascade permits simultaneous study of three independent input signals.

Many electronic switches are designed primarily for use in conjunction with cathode-ray oscilloscopes, to make possible the observation of two wave forms on a single cathode-ray screen. Such an arrangement is ideal for close examination and accurate comparison of two signals. Although the two wave forms are not actually on the screen simultaneously, they appear so to the human eye.

Trigger Circuits

An *electronic trigger* is a control circuit producing a source of electronic impulses which are used to cause an action in related circuits or devices connected directly to the output of the trigger circuit.

That is to say, the output impulses may start the operation of a secondary circuit or device. Or they may stop such operation. Or they may cause some other single electronic action to transpire sooner or later than it would normally.

The important characteristic of trigger-circuit impulses is that the *leading edge* of each pulse is the governing or controlling part of the wave form (See Fig. 1-b). Trigger impulses thus require no degree of definition or sharpness to their trailing edges, which considerably simplifies their generation and formation.

Pulse-forming circuits — similar to those previously described — may be used to produce trigger pulses. Simpler circuits can be employed, and the variety is extremely wide and flexible.

Every self-operated saw-tooth time base incorporates a trigger device of one kind or another. Thus many kinds of saw-tooth generators are immediately embraced into the family of trigger circuits. To these must be added most

(Continued on page 74)



Courtesy General Electric Co.
Photo B—A switch for study of two signals.

Television 1947!

Amateurs, Experimenters, Radio Servicemen... Now you

have access to the secrets of post-war television. Vision Research Laboratories now brings you in its new series of television booklets complete and detailed plans for the construction of a 5- or 7-inch television-FM receiver! The plans in these books incorporate all of the latest design features plus a detailed parts list. There is no need to wade through textbooks to get this necessary information. These booklets furnish you with all of the information needed for the construction of television receivers, sweep alignment generator, etc.

NOW AVAILABLE "Design and Construction of a Modern 5- or 7-inch TELEVISION RECEIVER" and "Design and Construction of a Visual Alignment SWEEP SIGNAL GENERATOR." Each booklet contains: Many pages of theory and practical design information. Detailed sketches, layout photographs and schematic diagrams. In addition, each booklet is furnished with an 11 x 17 inch wall chart working diagram.

Order direct or through your local distributor!

VISION

Research Laboratories

P.O. BOX #52, Kew Gardens 15, N. Y.

Enclosed is \$..... (Check or money order) for:

No. of Copies

.....Television Receiver Booklet at \$2.00 ea.

.....Sweep Generator Booklet at \$2.00 ea.

Name.....

Address.....

City..... Zone.....

State..... C-3

In New Jersey...
...it's **VARIETY**...

RADIO KIT
A.C.-D.C. 5 TUBE
SUPERHET

\$18.95
with tubes

Modern Plastic Cabinet
Built in Aerial, Complete
with Tubes including:
60L6, 35Z5, 12SK7, 12SA7, 12SQ7

\$14.45
less tubes

RADIO KITS by "EASY BUILT"

Model No. 2 Model No. 2 Kit.



AC-DC Electric Battery
Kit with Cabinet complete with Tube, Special Variable Condenser, Earphones, Resistors, Hardware and Special Fittings. Completely Wired Tube Socket. Diagram on Mounting.

Base—Ready Cut and Drilled **\$5.01 each**

Model No. 2B. Battery operated, easy tuning, attractive wood finish cabinet. Complete with Tube, Coil, Battery, Headphone, Hardware and Base. List Price ... \$4.98

Special \$3.33

Kit No. 1 **2.13**
Kit No. 1X **2.13**

Federal Teleco Selenium Rectifier

Replaces Rectifier Tube **\$1.09 each**
6 or more **99c each**

Famous Brand

Volume Controls with Switch

75c each 10 for **\$6.96**

5,000, 10,000, 25,000, 50,000, .1 meg, .25 meg, .35 meg, .5 meg, 1 meg 50% tap, 2 meg 50% tap. Outside diam 1 1/4", shaft length 3". Hat 3/4".

RESISTOR CABINETS

All wood construction. Six shelves, 24 compartments **\$3.89**

R.C.A.-T65 CABINET

Packed in original carton. Beautiful inlaid veneer with grill cloth. Speaker baffle for 5" speaker. Rubber feet. **\$4.95 each**. Three for **\$14.00**

Bargain! Guaranteed!

100 Assorted Bypass Condensers

Value **\$11.00**
Special \$6.95

SPECIAL! 20 x 20 150 WV. Electrolytic condensers. Fresh stock, guaranteed. Value \$8.75 **10 for \$4.95**

WELLER SPEED IRON

Saves Time and Money
Soldering heat in 5 seconds.
For Radio, Electronic, Telephone, Telegraph, Test, Repair, Laboratory, etc. Complete with 2 extra tips. **\$12.95 net**

SUPERIOR
Model 670
Super-Meter



A Combination Volt-Ohm Milliammeter plus Capacity Reactance Inductance and Decibel Measurements.

Complete with test leads and instructions **\$28.40**

Write Dept. C-3 for our FLYER. 20% Deposit with order required. Please add sufficient postage. Excess will be refunded.

Variety ELECTRIC CO., Inc.
601 Broad St., Newark 2, N. J.

SWITCHING and TRIGGERING
(Continued from page 73)

of the relaxation and negative-resistance oscillators, since trigger circuits actually form the fundamental basis of their operation.

Probably the most popular of the present-day electronic trigger circuits are the Eccles-Jordan and flip-flop oscillators, with their many variations.

One such variation, using a single pentode tube, is shown in the trigger circuit of Fig. 7. Resistance coupling is used between the suppressor and screen grid. The circuit may be placed in operation by any one of three methods: (1) by inserting voltages in series with any of the supply voltages, (2) by changing any of the circuit resistances, and/or (3) by voltage impulses applied directly to the grid of the pentode. In actual practice, the most sensitive electrode for triggering purposes is the control grid.

Trigger circuits are widely used to control multivibrators and almost all types of electronic oscillators. There are also numerous methods for using electronic triggers as control devices.

For example, the voltage across a coil or resistance in the trigger circuit may be applied as a control voltage to a component or tube of a secondary circuit. Or, the current passing through some part of the trigger circuit may be used to operate a relay or other current-controlled device in another circuit. In some electronic applications the current drawn by a grid-limiting resistor is used to operate a relay in another circuit; and in other cases the entire voltage drop across a vacuum tube is used to trigger a secondary circuit.

WIRELESS PHONO OSCILLATOR

Transmits recordings from phono pickup or voice from mike to radio without use of wires up to 500 ft. Neatly designed.
Complete kit, less tubes \$3.49
Above kit assembled and tested 4.49
Tubes for above kit (12SA7, 35Z5) 2.49

IMMEDIATE DELIVERY

SEND FOR BIG BARGAIN BULLETIN!

CONSTANT ELECTRIC, Dept. C

112 Cornelia Street Brooklyn 21, N. Y.

Deluxe Radio Parts Assortment

\$5.00
PER KIT

Contents Include All This:

- THROAT MIKE
 - MOTOR OR DYNAMOTOR
 - TRANSFORMERS
 - SWITCH BOX
 - SWITCHES
 - KNOBS
 - RESISTORS
 - CHOKES
 - COIL FORMS
 - TUBE SOCKETS
 - PILDT LITE W/BULB
 - CONTACT POINTS
 - INSULATORS
 - FLEXIBLE SHAFTS
 - TERMINAL BOARDS
 - CONDENSERS
 - RELAYS
 - FUSE HOLDER
 - AND MISC. SMALL PARTS
- Shipping Weight over 20 lbs.
SEND ONLY \$5.00 for each kit wanted.
NO C.O.D. ORDERS FILLED
ALL SHIPMENTS BY RAILWAY EXPRESS
CHARGES COLLECT

GEORGE BROOKS & ASSOCIATES
220 SOUTH HALSTED STREET CHICAGO 6, ILLINOIS



U. S. GOVERNMENT SURPLUS ELECTRON TUBES

Type	Your Cost	Type	Your Cost
2AP1	\$ 2.50	805	\$3.50
2D21	.60	807	1.00
2X2/879	.90	808	3.00
OA3/UR75	.60	809	1.50
OD3/UR150	.60	810	2.75
S-DB-3/UR90.60	.60	812	2.00
SOQ3/UR105	.60	815	2.00
3AP1	3.50	829A	3.00
3AP1A	3.50	866A	.75
3AP4	3.50	921	.75
3BP1	3.50	922	.75
3BP1A	3.50	923	.75
5BP4	6.00	927	1.00
6AK5	1.50	1851	.95
7EP4	15.00	1852	.75
HK24G	2.00	1853	.75
75TL	3.00	2050	.90
100TH	4.75	8005	3.50
HF200	8.50	9001	.95
450TL	15.00	9002	.85
800	2.50	9003	.95
U801A/801	2.00	9004	.85
802	1.50	9005	.95
803	8.50	9006	.75

Subject to prior sale
MAIL ORDERS FILLED PROMPTLY



509 ARCH STREET
PHILADELPHIA 6, PA.

LO 3-4559

LO 3-0513

**RADIO-ELECTRONICS
MONTHLY REVIEW**
(Continued from page 19)

From time to time the statement has appeared that in my invention I contributed the grid to a rectifier, the Fleming Valve, and thereby created the Audion or the three-electrode tube, the present heart and soul of radio communication. What could be more simple in the way of an explanation? What at the same time further from the truth, and still further from a knowledge of the simple facts of electronic principles?

To recognize that the anode voltage is as essential a feature of the Audion as is the third electrode, that by virtue of this local energy alone is the Audion a relay device, and therefore an amplifier of transcendent value, instead of a mere rectifier of received alternating currents—seems so self-apparent, that I have always been at a loss to understand why anyone should fail to grasp it.

Add a third, or any number of electrodes, to the Fleming Valve and it remains a valve—a mere rectifier, possessing the utility of the rectifier and nothing more.

The evolution of the Audion patent claims marks, in a general but incontestable manner, the evolution of the Audion—first it was a gas effect in the open air, then in an enclosed vessel, then in an exhausted vessel, exhausted like an incandescent lamp—then to higher and higher degrees of vacuua (as early as 1912 I employed an X-ray vacuum). But it was always a relay. Always the B-battery was employed. The control-electrode idea even preceded the enclosed vessel. And *never* was the Audion "the Fleming Valve with merely a grid added."

Following the close of the first World War, I resumed my early broadcasting work, using the oscillator tube at the transmitter and the audion detector and amplifier at the receiver. With these three necessary components at that time so well developed, the possibilities of the radio broadcast began to be appreciated by various commercial agencies and with such zest that in the 1920's a new major industry had attained maturity, demonstrating its unlimited possibilities commercially and culturally, fittingly to be described as an expanding universe, an instrumentality which has been justly compared with the invention of printing.

The electron emerged from the university laboratory briefly before the beginning of the century. Its application to the service of man dates from the first knowledge of how to control its migrations through vacuo. Starting with that discovery the utility of this new physical tool has so amazingly accelerated that the first half of our century is fittingly termed "The Electronic Age."

From such humble tasks as control of a drinking fountain to transmitting a signal to our moon and return, even to those involved in the process of the cyclotron, where the foundation stones of our universe are shattered, scarcely

THE SECRET'S OUT!

The New and Spectacular
ACA-100DC AMPLIFIER
Is Ready For Delivery!

DESIGNED BY A. C. SHANEY



A revolutionary development in amplifiers cleverly designed to defy obsolescence and amazing in its performance. New circuits, new materials and new processes are actually combined in this one amplifier to produce the most satisfying musical amplifier the world has ever known. If you are one of those discriminating persons for whom nothing less than the best is a disappointment, you are one for whom the ACA-100DC was designed. Send for technical literature.

AMPLIFIER CORP. of AMERICA

398 Broadway, New York 13, N. Y.

A. C. Shaney's FM-AM AMPLIFIER MANUAL is still available at 25c



NEW! *faster, easier servicing by "listening in" with*
PRECISION ELECTRONICS SIGNAL TRACER

Real versatility! The "number one" instrument in any Service Man's equipment. Probe with Polystyrene tip (operates on frequencies up to 300MC), top quality parts throughout and exclusive engineering features. *Outstanding "on-the-job" superiority!*

\$29⁹⁵ Checks signal stage by stage in R.F., I.F., and Audio sections. Speeds location of intermittents, opens, shorts, hums and noisy circuits with set hot or cold—checks coils, condensers, transformers, resistors, speakers, tubes! See your Jobber or write for descriptive literature. (Please address Dept. C3).

**COMPLETE
115 VOLTS
50-60 CYCLES**

PRECISION ELECTRONICS, Inc.

641-643 MILWAUKEE AVENUE
CHICAGO, 22 ILLINOIS



ELECTRONIC VOLT-OHMMETER

\$11⁸⁵ **110 VOLTS AC 20 RANGES**
0.5/10/50/100/500/1000/5000 volts DC and AC. 0-1,000,000,000 ohms in six overlapping ranges. Sensitivity: over MILLION OHMS per VOLT on 5 volt range.

POSTPAID

Complete kit includes all component parts, tubes, punched and drilled chassis and beautifully enameled panel. Easily assembled and wired.

Special atiltback circuit developed during war by scientist at the California Institute of Technology gives amazing sensitivity and flexibility while completely eliminating necessity of batteries and expensive meter. Each instrument is individually calibrated. Dial scale over nine inches long!

In addition to performing the usual volt-ohm functions, this instrument easily measures these voltages: SUPPLY VOLT OSCILLATOR, AVC, AFC, TRUE GRID BIAS AT THE GRID, BIAS CELLS without affecting the circuit. Measures the exact leakage resistance of INSULATION, TUBES, CONDENSERS. It can be used with a signal generator for SIGNAL TRACING.

STERLING ELECTRONIC COMPANY
166 N. Sierra Bonita Ave., Dent. 2, Pasadena 4, Calif.

THE YEAR'S BIGGEST OFFER

10 lb. Radio Parts Assortment

A "find" for the radio serviceman. Hundreds of valuable radio parts, including coils, resistors, trimmer condensers, lugs, transformers, switches, hardware, etc.

Only \$1.95

Write for radio parts circular

RANDOLPH RADIO STORES
609 W. Randolph St. Chicago 6, Ill.

a phase of activity in science, technology, or medicine has failed to demand essential aid from the vacuum electron.

Following world communication and broadcasting the tube with its manifold

circuits has produced the talking picture, the living reproduction of recorded music, and Television—gigantic new industries, now or soon to be.

(Continued on page 76)



**Dial Belt Kits - Alignment Kit
Ne-O-Lite Tester - Contact Cleaner**

**G-C SERVICEMEN'S DIAL
BELT KITS**



Specially designed no-slip replacement belts for all sets. No stretch. Easy to install. Kits of various quantities supplied with Steel Box. No. G-25 Kit of 25 belts.

List \$6.70

**G-C ELECTRONIC
CONTACT CLEANER**



Improved red color contact cleaner made with G-C Lube-Rex; cleans faster, dries faster; on drying leaves protective film on contact without affecting electrical characteristics. No. 210-2-2 oz.

List 35c

**G-C No.5023 ALIGNMENT
KIT**



Complete kit that will take care of most sets. Contains nine excellent tools, with leatherette case.

List \$6.25

**G-C NE-O-LITE
TESTER**

Handy, inexpensive; a tester that everyone needs for countless uses. Can be used on 60 V.A.C. to 500 V.A.C. or D.C. No. 5100- single tester on card.

List 50c



G-C PRODUCTS ARE AVAILABLE AT LEADING DISTRIBUTORS WRITE FOR CATALOG TODAY

Displays of 12 or 20 available

RADIO DIVISION DEPT. D

GENERAL CEMENT Mfg. Co., Rockford, Ill., U.S.A.

Manufacturers of over 3,000 products • Sales offices in principal cities

**RADIO-ELECTRONICS
MONTHLY REVIEW**

(Continued from page 75)

Outstanding names among early leaders in electron investigation are Pierce, Chaffee and Zworykin, that genius who wedded the Iconoscope to the grid amplifier to give Television to the world.

Here in glass and metal lies the control of the world's greatest force, the electron. Here is man's eye to see through solids, beyond horizons, and to behold the infinitesimal, to make audible the inaudible, his voice heard around the world, his mastery of time, temperature and motion.

In the electron tube lies the safety of all who fly, making possible today's crowded aviation; the tube which now stands mutely asking leave to end collision, by water, air and rail; there lacking only sufficient of man's humanity to man to put it, generally and intensively, to that merciful job.

I count myself most fortunate among men to have been granted to live to see this gigantic unfolding of an implement, and an idea, which first came to me more than 40 years ago.

A.C. MAGNETIZER

An a.c. magnetizer will often prove useful around the shop for magnetizing screw drivers and other small tools and parts. It may also be used to remove troublesome magnetism.

The magnetizer consists of an old 6-volt speaker field coil, a porcelain light socket, and a quick-acting switch, all mounted on a firm wooden base. The field coil is firmly clamped onto the base and wired across the 117-volt a.c. line in series with the switch and socket. If the coil has a resistance greater than 10 ohms (roughly), then a 10-amp fuse can be used in series, but if the resistance is much lower, then a 660-watt heater element should be used. The switch can be any push-button type, or can be made from a strip of tin with an insulated knob on the end, a key-type switch being easier and faster to use.

To use the magnetizer, place the object to be magnetized in the field coil, push down the switch, and while holding down, draw the article out of the coil, thus completely demagnetizing it. Then replace the object in the coil, and give the switch a quick tap. To successfully magnetize anything, the connection must be made and broken while the a.c. is at the peak of a cycle, therefore, several attempts may have to be made until the object is sufficiently magnetized. When the switch is held down too long, the next cycle will reverse the field and demagnetize the metal. If the article is not held firmly when magnetizing, it may be shot out through the coil. To magnetize objects too large to enter the field coil, various jigs may be made which will fit into the coil and conduct the magnetism to where it is needed.

LEWIS SWANSON, JR.,
Toronto, Canada

Radio Service Man

How Much Is Your Time Worth?

"SAVE IT"

**By using Verified Speakers
and making the first installation
a permanent installation**

WRIGHT

INC.

2232 University Ave.

ST. PAUL 4

MINNESOTA

RADIO MEN

Write for Bargain
Catalog of Radio Parts

BUYERS' SYNDICATE

786 Carew St.

Springfield, Mass.

RADIO SERVICEMEN: SPECIALS

TUBES-50L6, 12SA7, 35Z5, 12SK7, etc.	50% OFF
LOOP ANTENNA 5" x 8" HI Gain	.41
SAPPHIRE PHONO NEEDLE (10,000 plays)	.99
BY PASS COND. 600 V. .005, .01, .02 mfd.	.07
FILTER COND. 20-20 mfd. 150 V (Special)	10 for
MALLORY 10-10 450 V. 20 25V F.P. Cond.	.85
TREBOR SPEAKERS 6 inch PM Alnico 5	2.39
TREBOR SPEAKERS 4" or 5" PM Alnico 5	1.69
DIAL CORD KIT 100 ft. Ass'd G & O springs	1.35
KNOB KIT-20 Ass'd screw and spring types	.99
PHONO AMPLIFIER 3 Tube (Less Tubes)	3.25
RADIOS-5-TUBE SUPER (Nat. Known)	18.95
Write Today for Bargain Bulletin	
RADIO DISTRIBUTING CO., Pasadena, 18, Cal.	

Order from LAKE!
You'll Make No Mistake!
RADIO Cabinets & Parts
NOW Available!



**Postwar
2 Post
RECORD-
CHANGER**

With luxurious brown leatherette portable case 15" L x 15" W x 10" D. Latest electronic developments make this modern record-changer the finest on the market today!

Changer—\$18.50 Cabinet for same—\$8.95

Also blank table cabinets of walnut veneer in the following sizes, with speaker opening on left front side. (Note: 7" has center speaker grill.)

- #1 — 8 1/4" L x 5 1/2" H x 4" D \$1.95
- #2 — 10 1/4" L x 6 3/8" H x 5" D \$2.75
- #3 — 13 1/2" L x 7 3/4" H x 6 1/4" D \$3.25
- #4 — 10 3/4" L x 7" H x 5 1/2" D \$2.50

*Speaker Opening in center of front side.

All types of radio cabinets and parts are available at Lake's lower prices. A large stock is listed in our catalog.

SERVICEMEN—RETAILERS
Join our customer list today.

Write today for our new 16-page illustrated catalog NR-116. It's free. Get on our mailing list. Dept. C

LAKE RADIO SALES CO.
615 W. Randolph Street, Chicago 6, Ill.

OPPORTUNITY AD-LETS

Advertisements in this section cost 20 cents a word for each insertion. Name, address and initials must be included at the above rate. Cash should accompany all classified advertisements unless placed by an accredited advertising agency. No advertisement for less than ten words accepted. Ten percent discount six issues, twenty percent for twelve issues. Objectionable or misleading advertisements not accepted. Advertisements for April, 1947, issue must reach us not later than February 28, 1947. Radio-Craft • 25 W. B'way • New York 7, N. Y.

FOR SALE—COMPLETE FILE SHORT WAVE CRAFT. also other magazines. Write for list. Don Yocum, Farmer, Ohio.

TUBES (LOOSEPACKED) 6V6GT, 75, \$3.99 EACH, 1116G, \$4.99 each, 25Y5, \$4.99 each. All tubes are guaranteed. S & S Radio Co., 140 Derby St., Salem, Mass.

FOR SALE: OVER 600 RADIO MAGAZINES—ELECTRICAL books. List free. E. S. Hillery, W26NK/9, Elmwood, Illinois.

UTAH 5" SPEAKERS, 450 OHM FIELD, \$2.36; C.D. 50-30 mfd at 150V, condensers, .95; C.D. 20-20 mfd at 250V, condensers, .90; 1/2 meg. Volume control with switch, .75; Bypass condensers, .01, .02, .05, 200V, .05; AC-DC Phono. amp. complete with 3 tubes, \$6.35. Brand new radio tubes 55% off list. We have a complete stock of parts. Write your need. Walmar Distributing Co., Radio & Electronic Parts, 3803 Beecher Ave., Baltimore 15, Md.

BUILD RADIO, PHONOGRAPH, OR COMBINATION. complete kits. Catalog Radion, 6922C 21st Ave., Brooklyn 4, New York.

RADIO MEN—LOWEST PRICES IN AMERICA. BIG Stock. Write for latest Catalogue. McGee Radio, 1330 Broadway, Denver, Colorado.

BARGAINS: RADIO, TUBES, PARTS, NEW AND USED. Joe T. Morrow, Wolfe City, Texas.

CORRESPONDENCE COURSES AND SELF-INSTRUCTION books slightly used. Sold, Rented, Exchanged. All subjects. Satisfaction guaranteed. Cash paid for used courses. Complete information and 100-page illustrated bargain catalog free! Write—Nelson Co., Dept. 39, Chicago 5, Ill.

WE REPAIR ALL TYPES OF ELECTRICAL INSTRUMENTS, tube checkers and analyzers. Hazelton Instrument Co. (Electric Meter Laboratory), 140 Liberty Street, New York, N. Y. Telephone—BARclay 7-4239.

MAGAZINES (BACK DATED)—FOREIGN, DOMESTIC, arts, books, booklets, subscriptions, pin-ups, etc. Catalog 10c (refund). Clearcom's, 863 First Ave., New York 17, N. Y.

AMATEUR RADIO LICENSES, COMPLETE CODE and theory preparation for passing amateur radio examinations. Home study and resident courses. American Radio Institute, 101 West 63rd Street, New York City. See our ad on page 84.

FREE WHOLESALE BULLETIN TUBES, PARTS. Bargain prices. Henshaw Radio Supply, 3313 Delavan City, Kansas City, Kansas.

WANTED COPIES OF "MODERN ELECTRICS" AND "Electrical Experimenter." State price. Box GT, % Radio-Craft.

"WIRE RECORDER HEAD—RECORDS, REPRODUCES, erases. Highest quality laboratory instrument. Brush made for Government. Value \$12.50. Our price \$2.50 with order. Radloco 1110R Marshall Bldg., Cleveland, Ohio.

FUNDAMENTALS OF RADIO, ILLUSTRATED, 373 pages \$2.75. Kelly, 1617 Stocker, Flint 3, Michigan. **GUARANTEED, TESTED, .05-400 VOLT CONDENSERS,** Leads 1/2" to 1". Factory surplus, 10 for .50; 100 for \$2.98. Bryant Radio Shop, Decorah, Iowa.

MULTI-STATION INTERCOMS
(Continued from page 37)

The Talk-Listen switch in Figs. 1 and 2 is a rotary wafer-type switch with two positions and a spring action. In the upper or normal position, the station is in a listening condition; when the switch is held down (by a long offset bar knob) the user may transmit. In the "listen" position, the amplifier input is disconnected and the speaker connected to the incoming line corresponding to the station number. The upper station is No. 1 and connection "x" is made to line 1. The lower is station 2 and the "x" connection is to line 2. Now, if station 2 presses down his T-L switch, his speaker is transferred to his input transformer. His output transformer is connected, through the station selector, to line 1 and thence to the speaker of station 1, where his voice is heard. Then he releases his T-L switch and station 1 may connect its speaker to its input transformer, and its output transformer—through its station selector—to line 2 and the speaker of station 2. Each station, of course, selects the station to which he wants to talk by means of the station selector. The number of stations available is determined only by the number of points on the selector and, with standard switches, may be as high as 11, if the off position is omitted.

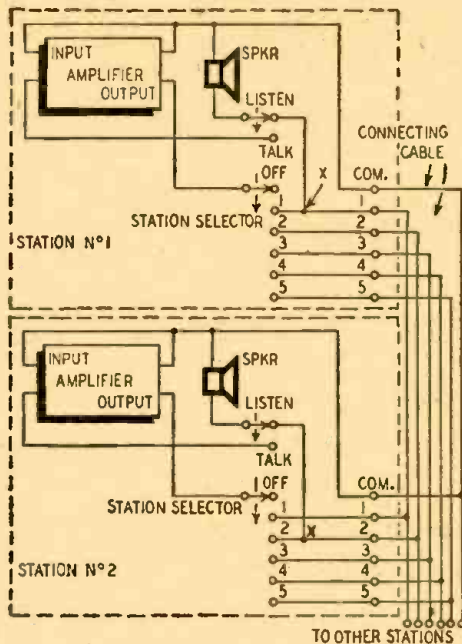

Fig. 2—Master-to-master switching system.

There is, of course, some slight hum in these amplifiers. If the selector of any station is left connected to a line, the station to which it is connected will hear the hum. While this is not excessive, provision of an off position silences the system. Another important point is the privacy. Note that no station can listen to a conversation uninvited, since the transmitting station selects the station to which it will talk. A station cannot select the station to which it would listen. Of course, as many separate conversations can be carried on over this system simultaneously as the number of lines permits.

**LEARN
ELECTRIC MOTOR
REPAIR!**



**A PROFITABLE
ADDITION TO
ANY RADIO SERVICE
BUSINESS**

This big book shows you how—every step of the way—

only **\$5**

**IT PAYS TO SPECIALIZE
IN SOMETHING DIFFERENT**

There's good money in electric motor repair! The field is not crowded—and what could be a finer more profitable addition to your already established radio service business? Every home you visit on radio work has many motor-driven appliances. Be the man who can repair them!

ELECTRIC MOTOR REPAIR, the unique new book by the publishers of the famous Ghirardi Radio-Electronic books, teaches you the work from the very beginning. Explains every detail of motor trouble diagnosing, repair and rewinding. Covers a-c and d-c motors, synchronous motors and generators and electrical control systems.

A "BENCH" BOOK

Based on what you can learn from this big book alone, you can train for prompt, profitable motor service. Quick reference guides for use right at the bench show exactly how to handle specific jobs. Invaluable for beginners or for daily reference in busy shops. Unique Duo-Spiral Binding divides book into 2 sections permitting text and the more than 900 diagrams and illustrations to be seen AT THE SAME TIME.

**"BORROW" IT FOR
5 FULL DAYS!**

Send coupon now! Practice from **ELECTRIC MOTOR REPAIR** for 5 days. If not more than satisfied, return book and every cent will be cheerfully refunded.

NO RISK COUPON mail today

Dept. RC-37, Murray Hill Books, Inc.
232 Madison Ave., New York 16, N. Y.

Enclosed is \$5 (\$5.50 foreign) for a copy of **ELECTRIC MOTOR REPAIR** book; or send C.O.D. for \$5 plus postage (no foreign C.O.D.'s). In either event, if not satisfied, it is understood I may return book in 5 days for complete refund of my money.

Name

Address

City & Dist. No. State

SENSATIONAL CLEARANCE of WAR SURPLUS EQUIPMENT at a Fraction of Its Original Cost

We offer hundreds of "hard-to-get" items in amateur radio supplies along with the best in "HAM" equipment—all at a great saving to YOU.

Our stock includes a wide assortment of:

- PLATE TRANSFORMERS, CHOKES, RELAYS
- FILTER CONOS, TRIMMERS, PADDERS, CABLES
- TUBES, TRANSMITTING, & RECEIVING CONDS.
- COAX CABLES, FITTINGS, WIRE, CRYSTALS
- SWITCHES, SOCKETS, DIALS, PLUGS, DYNA-MOTORS
- TEST EQUIPMENT COILS, CHOKES, POWER SUPPLIES
- RECEIVERS, TRANSMITTERS, RECTIFIERS, AMPLIFIERS
- HUNDREDS OF OTHER ITEMS

Our latest bulletin is just off the press giving complete descriptions, specifications and bargain prices. Get your copy of BULLETIN 2 RC today, also our latest bargain "tube" list.

NIAGARA RADIO SUPPLY CORP.
160 Greenwich St., New York 6, N. Y.
Please send me a copy of your latest BULLETIN 2 RC, listing hundreds of "hard-to-get" radio supplies; Bargain tube list, and place my name on file for future mailing.

Name

Address

City Zone State

Immediate Delivery On All
Items



NIAGARA RADIO SUPPLY
160 Greenwich St., New York 6, N. Y.
Bowling Green 9-7993

USEFUL BARGAINS At Greenwich Sales

SIGNAL CORPS AC LINE FILTER that really works. Hook it to your neighbor's receiver (or your own) and eliminate some of that BCI. **\$1.25**
Brand New

BATTERY BOX black crackle finish; 6 1/4 x 6 1/2 x 7 1/2 Internally wired for 90, 67 1/2, 1 1/2, 4, 3 volts. These voltages stamped on bakelite panel which contains binding posts for same. 8 binding posts inside. Carrying handle and 4 locks. **\$1.25**
Brand New

SEND FOR BI-MONTHLY BULLETIN CR
25% deposit required on all orders.
Prompt delivery assured.

GREENWICH SALES CO.
59 Cortlandt St. — Whitehall 3-3052
New York City 7, N. Y.

500 FORMULAS TO SUCCESS

MANY million dollar firms started with a single formula, for which they paid a big price. Here you have 500—no less—tried and tested formulas, recipes and processes for making things . . . all at the ridiculously low price of 25c. Here is your opportunity to start a business with but a few dollars' capital and with untreamed of profits in prospect. You can also use these formulas in your own home to cut household expenses to the bone. Or you can put them to use in your workshop to cut costs as much as 1000%.

Quit paying out many dollars in profits to manufacturers, wholesalers, and dealers, when you can make the same thing yourself for a few cents. It's so easy when you follow our simple instructions.



66 PAGES, 3200 WORDS IN TEXT
Send for "500 FORMULAS AND RECIPES" today. Enclose 25c, that's all! You won't be asked for another cent now or later. Sold on a money-back guarantee.

NATIONAL PLANS COMPANY
P. O. BOX 26 R, STATION N, New York 23, N. Y.

WHY RADIO SPECIALIZATION?

(Continued from page 17)

of other subjects. They are all young too—from 18 to 22—and they know their subject, often amazingly well. These young men find little trouble in securing lucrative positions. Laboratories, manufacturers, and others are always on the lookout for such men—indeed they write and phone us right along to fill existing vacancies.

This brings us back to our letter. We agree at once with the college educators who maintain that what the student needs is "generalization." The embryo-engineer to a certainty should know all there is to be known in Electrical, Mechanical, or Civil engineering BEFORE he attempts to specialize in any given subject.

You must be an excellent skater first before you can become a trick figure skater.

Our correspondent realizes this perfectly himself when he says as much in his third paragraph—"the large companies . . . realize the impossibility of (colleges) teaching a student all he should know." Precisely. And that is the unfortunate rub. I have maintained for over 30 years that college training in this country leaves very much to be desired. The fault is decidedly not the student's, but the faculty's. The teaching system is wholly inadequate in all too many of our universities. With the exception of a few really good institutions, the bulk of the others do not equip the student with a dense enough core of learning to face a harsh and practical dollar-minded world after his graduation. I am far from being the first to make this indictment—it has been made countless times before and it serves no purpose here to suggest the obvious, needed remedies.

The fact remains that probably 80 percent of our college graduates remain still "students" for many years to come. They just do not have the necessary knowledge to succeed soon, because their *fundamental knowledge is woefully inadequate.*

Thomas A. Edison, in his lifetime, as is well known, never employed recently-graduated college men. Over a stretch of 38 years as a pioneer radio manufacturer and technological publisher I have not found it possible to engage more than a total of four young college men out of a total of several thousand employees! Hundreds upon hundreds applied as technicians and for editorial positions that were open, but only a negligibly small percentage could make the grade. When they looked over the questionnaire which I had prepared to test their knowledge (see end of this article) they fled! Or if they attempted to answer it, the result usually was pitiful in the extreme.

This should not by any means be construed as an indictment against college personnel as a whole. Quite the contrary. There is no question that we could have employed dozens of excellent engineers if we had wanted older, ex-

perienced and high-salaried men. Unfortunately, in a specialized business it would be necessary to break in such men too, teach them our routine, special requirements, etc. That is most expensive if you employ \$5,000 to \$8,000 men. For that reason it is better to select younger, less experienced men, as long as they must be broken in to the work anyway.

Unfortunately, when it comes to generalization, as taught in colleges, the term *superficialization* would be more appropriate. Generalization is excellent if the student is taught the subject *thoroughly*. It is useless if the knowledge which he gains is sketchy. And in all too many cases that is what happens today. Most of our colleges attempt to teach too much, drill in too many subjects not too closely related, with too few teachers, in far too short a period. The result is obvious—inadequacy.

Then when we present the young graduate with a questionnaire to get under his skin and test his knowledge, he often will come up with the standard cliché: "Oh, that kind of stuff should be looked up in a textbook." That is like trying to learn a foreign language by consulting a dictionary—one is apt to draw the most erroneous and ridiculous conclusions. *There is no substitute for knowledge.*

Fundamentally there is nothing wrong with textbooks. Unfortunately students have not sufficient time really to study the books thoroughly. Nor do they study enough GOOD books as a whole. Often the selection of certain textbooks is unfortunate—for many are incomplete and outdated. Frequently a little-known volume may be better than many textbooks on the same subject. *Nothing becomes obsolete quicker than a radio textbook.*

In due time the intelligent graduate student learns how to equip himself with books, magazines and other technical literature. He learns "book" research as applied to his own endeavor, and thus makes up for the partial vacuum acquired during his whole college life.

To sum up: We certainly believe in Generalization before Specialization—IF the generalization IS THOROUGH.

If you do not agree with the statements made here, may we suggest that you test a number of young college graduates with the questionnaire that follows. The questionnaire is similar to one used for many years as a test by a number of our organizations.

Most of the subject questions can be found in textbooks or engineering papers in any good technological library. Every one deals with electricity, radio, or a subject closely related to both. There are no out and out "trick" questions. All are on practical subjects such as come up continuously in engineering.

Yet that young college man who can answer even 80 percent of the questions without referring to books must be

**WE SHIP ANYWHERE
IN THE WORLD**

Internationally Famous

FLANAGAN RADIO CORP.

**WHOLESALE DISTRIBUTORS
of
RADIO TUBES
RADIOS
RADIO PARTS**

FREE CATALOG

Send for free catalog and prices of hard-to-get Radios, Radio Tubes, Radio Parts, Pickups, Motors, Condensers, Tube Checkers, Volt and Ohm Meters, Signal Generators, Signal Tracers, etc.

FLANAGAN RADIO CORP.

America's Largest Stock of Radio Tubes
N. E. Cor. 7th & Chestnut Sts.
Phila. 6, Penna.—U. S. A.

Signal Corps 1-222A Signal Generator 8 to 15, 150 to 230 MC.....	\$69.95
300 Ohm Amphenol Twin Lead, per 100 ft.....	2.90
75 Ohm Amphenol Twin Lead, per 100 ft.....	2.00
75 Ohm Amphenol Klowatt Twin Lead per 100 ft.....	7.20
P23 Army Head Set, 8000 Ohm with 5 ft. Cord and plug.....	2.95
3 Gang 410 MMFD, Per Section Condenser, Ex- cellent Quality.....	2.95
BC 312 converted for 110 VAC.....	79.95
National ACN Dials.....	3.00
4 MFD 600 Volt Oilfilled condenser, standard can mounting.....	1.59
JAN 6AK5 Tubes.....	1.95
JAN type 2c40 Lighthouse tube, new in cartons	4.49

Complete line of RCA, TAYLOR, GE, and EIMAC
Tubes. Write Us Your Needs in Any Ham Equipment.
Send For Our Current Surplus Bulletin

DOW RADIO

1759 E. COLORADO PASADENA 4, CALIF.
Pasadena Phone—SYcamore 3-1196
Los Angeles Phone RYan 16683

*Supplying Every
Electronic Need*

- FOR THE—
- RADIO SERVICE MAN
 - AMATEUR
 - STUDENT
 - EXPERIMENTER
 - INDUSTRIAL

WRITE FOR ILLUSTRATED PRICE LIST

**CRABTREE'S
WHOLESALE RADIO**

DALLAS 2508 ROSS AVE. TEXAS

DE FOREST ANNIVERSARY NUMBER

We can still fill orders for the important big
de Forest number.
Sent on receipt of 50c stamps, check or
Money Order.

RADIO-CRAFT, 25 West Broadway,
New York 7, N. Y.

rated a first-class genius or a prodigy.
The answers to the questions that
follow may be found on page 80.

**STUDENTS'
RADIO QUIZ**

1. What is the composition and under what name is the most powerful type of permanent magnet known today?
2. If the fine wire hair-spring of a watch was magnetized accidentally, how would you restore the watch to perfect operating condition without taking it apart?
3. Without any electrical equipment how can you tell if a current supply is a.c. or d.c., merely by observing the light of an electric light bulb?
4. You are handed a positive and a negative lead storage battery plate. Which color is the positive, which is the negative?
5. You have a condenser such as used in radio. What tests do you make to find out if it is defective or still useful?
6. If no regular type of loudspeaker were available for a radio set, how would you make a condenser talk or get sound from it, to serve as a makeshift loudspeaker?
7. Give elements of a simple tone control.
8. Given the value of the parallel tuning condenser, how would you compute the inductance of a coil to resonate at 990 kc?
9. What is a coherer? Draw a diagram of a simple coherer and de-coherer.
10. How does an electron microscope work?
11. Sketch or give hook-up of a simple stroboscope.
12. Name the two main radio uses for selenium.
13. What is the Electret and how does it work?
14. How would you store electricity for a number of hours with well-known radio components? (Storage battery excluded.)
15. How can you generate from 75 to over 100 volts using only an ordinary electric house bell connected to a 3-volt battery? Sketch explanatory hook-up.
16. How would you devise a variable resistor to have no sliding contacts nor work on the compression or electrolytic principle?
17. What is the principle of the Bell Photophone and how does it work?
18. What form of natural lightning travels only a few feet per second and is often deadly?
19. What is an Ano-Kato? How does it work?
20. How does an electric Trevelyan Rocker operate?
21. What is the Hughes Induction Balance?
22. What is used as a depolarizer in an ordinary dry cell?
23. Describe a Geissler tube.
24. What is a Spintharoscope?
25. How can you generate cold with two metals and a battery?

FOR ANSWERS TURN TO PAGE 80



ALLIED
Sound for '47!
**New 30 WATT DeLuxe
PORTABLE P. A. SYSTEM**

Here's a preview of ALLIED Sound for 1947 in this smoothly-styled, brilliantly engineered 30 Watt De Luxe Portable System. New stabilized inverse feedback circuit delivers high output, usable right up to its peak. Flexible operation is provided by two microphone and one phono channels, each with separate control. Has bass-treble tone control. Amplifier and speakers are safety-fused. Amplifier gain on microphone is 128 db; on phono, 80 db. Frequency response: 50-10,000 CPS. System covers up to 4,000 persons, or up to 20,000 square feet.

Complete 30 Watt System includes: 30-Watt De Luxe Amplifier with tubes; 2-12" Safused Dynamic Speakers, with 30-ft. cables and plugs; 1-Cardax Unidirectional Microphone with floor stand and 20-ft. cord and plug. Complete in hand-some luggage-type split portable carrying case, 22"x20"x15". Carrying wt., 60 lbs. For 110 volts, 60 cycles A.C. (Less phono top which is optional.)

Complete System \$105⁷⁵
Only

ALLIED
*For Everything
in Radio and
Sound*

See your ALLIED Catalog No. 111 for the world's largest and most complete stocks of quality radio and sound equipment—at today's lowest prices! Count on ALLIED for fast service, expert help. If you haven't a copy of Catalog No. 111—send for it now—it's FREE for the asking.

ALLIED RADIO

ALLIED RADIO CORP.
833 W. Jackson Blvd., Dept., 2-G-7, Chicago 7, Ill.
 Ship 30-Watt Portable System described above. S..... enclosed.
 Send full details on ALLIED Sound.
 Send FREE Radio Catalog No. 111.

Name.....
Address.....
City.....Zone.....State.....

ANSWERS TO STUDENTS' RADIO QUIZ

On Page 79

SURPLUS TUBES at BARGAIN PRICES

All Tubes New and Sold Under
New Tube Guarantee

5CP1	-3.95	884	-.99	6J5GT	-.51
5BP1	-4.95	885	-1.05	6L6G	-1.20
5BP4	-4.95	8012	-1.25	6L7	-.99
5JP1	-9.95	15E	-1.25	6SD7	-.65
3BP1	-3.45	15R	-1.25	6SH7	-.65
954	-.89	E-1148	-.69	6SL7	-.89
9002	-.89	2C26	-1.30	6SN7	-.69
1619	-.89	EF-50	-.79	12SK7	-.80
1625	-.70	VR 105	-.99	6X4	-.69
1629	-.89	2050	-1.30	6Y6G	-.89
1631	-.99	7193	-.99	12A6	-.99
1633	-.89	UH50	-3.95	12C8	-.79
1644	-.99	10Y	-.99	12SN7	-.79
2C40	-2.30	5R4GY	-.99	37	-.49
2C43	-4.25	864	-.60	1G6	-.87
3C45	-1.40	6X5	-.89	1J6	-.87
100TH	-8.25	843	-2.75	12SQ7	-1.05
2051	-1.35	811	-2.00	34	-.80
801A	-2.05	6F8	-.92	30	-.80
802	-2.05	6SJ7	-.74	83	-.92
803	-7.95	75	-.70	6K7	-.79
805	-5.25	70L7	-1.65	104	-.79
813	-7.50	1R5	-.79	6B8G	-.79
826	-4.25	2X2A	-1.05	6AC7	-.99
6SQ7	-.80	3A4	-.79	6AC7	-.84
1616	-.99	3Q4	-.89	39.44	-.60
717A	-1.05	6AB7	-.84	5Y4	-.63
713A	-.85	6AB5	-1.05	5Y3	-.63
371A	-1.29	6AK5	-1.30	6K6	-.69
1960	-.75	6AL5	-.89	6W7	-.79
836	-1.75	6A4	-.64	12SF7	-.69
837	-2.10	6C5	-.59	6SK7	-.79
866	-1.25	6H6GT	-.56	6J7	-.80

Minimum Order on Tubes \$2.00

USED DYNAMOTORS input
12 V.D.C.—2.3 A., output 250 V.D.C.—
.05A, 5000 R.P.M. constant duty, ap-
prox size 4½"x2½" dia.
Special \$2.10

NEW No. 631P1/SNA Glass
Strobotron tubes. Each \$4.25

All Prices FOB New York City, N. Y.
Send for Our FREE Monthly Bulletin

**Highbridge Radio-Television
and Appliance Co.**

340 CANAL STREET NEW YORK 13, N. Y.

- Alnico 5. The magnet contains aluminum, nickel, cobalt and iron.
- Insert watch into field of an a.c.-excited coil and withdraw slowly. If no a.c. is available, suspend watch on twisted string in front of poles of a magnet; allow string to unwind while slowly withdrawing the spinning watch from magnet.
- At arm's length, rapidly wave a pencil back and forth in front of lamp. It appears to flicker on a.c.
- Positive plate is brownish red; negative plate is bluish gray.
- (a) Test for short with continuity tester, (b) Momentarily connect across d.c. source. Then short condenser terminals. Spark indicates condenser is undamaged.
- Assemble ten or more tinfoil and paper leaves loosely, placing rubber bands around the assembled condenser. Connect across primary of set's output transformer. Condenser will reproduce radio program.
- Connect a condenser and variable resistor in series between plate and ground of an a.f. amplifier.

$$8. \text{Inductance (henrys)} = \frac{1}{4\pi^2 f^2 C}$$

(C is in farads, f in cycles.)

- First device used to detect wireless waves. A glass tube has two silver plugs, between which are placed a small quantity of metal filings (90 percent iron, 10 percent silver). See diagram.

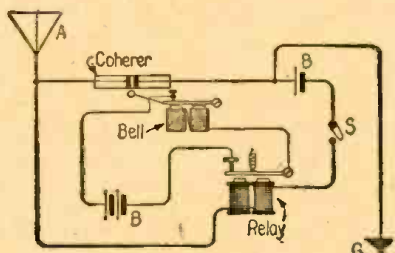

The coherer, first detector of radio waves.

- Electrostatic or electromagnetic lenses refract a beam of electrons just as glass lenses refract a beam of light. Specimen to be examined is placed in the beam, and the visible image is formed by the electrons and shadow from specimen falling on a fluorescent screen.
- See sketch.

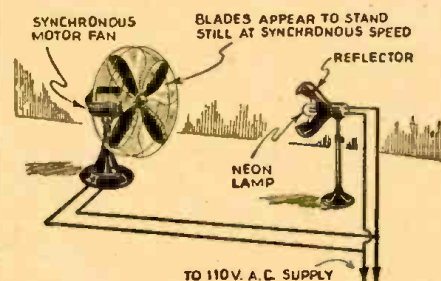

A simple stroboscope demonstration set-up.

- Selenium is used for photocells and rectifiers.
- The electret is a mass of wax which has been given a permanent electrical

- charge. It is then an electrical analog of a magnet. In bar form, one side of end carries a positive and the other a negative charge.
- Charge a high-quality condenser. It will hold a charge for several hours.
- By using the self-induction of mag-

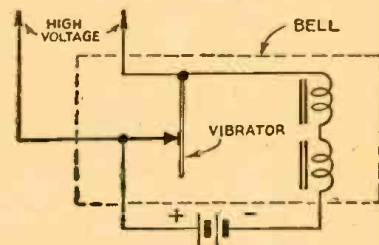

High voltage is obtained from self-inductance of bell coils.

nets in the ordinary electric bell. See diagram.

- Bare resistance wire is wound from an insulating drum onto a metal one. This short-circuits the wire and its resistance is eliminated from the circuit. Another variable resistor is the plate-cathode resistance of a vacuum tube, which varies with changes in applied grid bias.

Light is directed through a lens and prism onto a mirror mounted on a diaphragm, fitted to a mouthpiece. Reflected light from the diaphragm mirror is thus modulated by the voice. At the receiver the light falls on a selenium cell (at focus of a parabolic mirror). Variation in cell's resistance modulates bat-

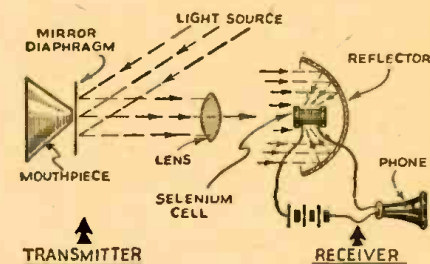

Simplified diagram of the Bell Photophone.

tery current, which is turned into sound by the telephone receiver.

- Ball lightning, a globular form of natural electrical discharge infrequently observed during electric storms.
- A static-electricity toy. A shallow box is lined with tinfoil. Pith balls or small paper dolls are put into the box; cover is a piece of window glass. If glass is rubbed briskly with a piece of fur, static electricity generated animates pith or paper figures.
- A scientific device operated by repeated heating and cooling of contact between a brass rod with a V-shaped slot along its lower edge and a lead supporting rails. See illustration. Current from battery passes through rod and supporting rails. Lead expands instantaneously due to heat produced at one contact (in practice it is found that more current starts flowing at one contact than the other) and a sharp push is given to the rod, which rotates slightly, causing lead at other contact to ex-

MORE SMASH BUYS at National Radio Distributors

IMMEDIATE DELIVERY

Famous National Radio Kits!

Now! The new and improved post war design. All component parts perfectly matched and mounted for easy wiring. Modern plastic cabinet features dust proof back. All kits complete with the new Alnico 5 P.M. speaker and full instructions for easy assembling. 110 V. C.C. D.C. 220V. \$1.00 additional. White cabinet available \$1.00 additional.



- N.R. 1-4 TUBE T.R.F., uses 12SK7, 12SQ7, 50L6, & 35Z5 tubes. Your Net \$10.95
- Kit of 4 matched tubes. " " " 3.50
- N.R. 7-5 TUBE SUPERHETERODYNE, uses 12SA7, 12SK7, 12SQ7, 50L6, & 35Z5 tubes, and features built-in loop antenna. Your Net \$11.95
- Kit of 5 matched tubes. " " " 4.50
- N.R. 5-5 TUBE SUPERHETERODYNE "TWO" BAND, uses 12SA7, 12SK7, 12SQ7, 50L6, & 35Z5 tubes. Built-in antenna. Your Net \$13.95
- Kit of 5 matched tubes. " " " 4.50
- N.R. 6-6 TUBE SUPERHETERODYNE, uses 2-12SK7, 12SA7, 12SQ7, 35L6, & 35Z5 tubes. Your Net \$13.75
- Kit of 6 matched tubes. " " " 5.50

THIS MONTH'S SPECIALS

- RADIO TUBES, all standard brands, all fully guaranteed 12SK7, 12SQ7, 25L6, or 50L6. Each net \$8.83
- 25Z6, 25Z5, 6A7, 6A8 or 35L6. " " " 7.94
- 1A7, 1H5, 1N5, 12SA7 or 6Q7. " " " 1.79

PHONO MOTORS.

- Self-starting, 9" turn-table. Your Net \$2.95
- Russell Ballantyne, 9" turn-table. List \$7.30 net \$4.29
- Alliance Model 80, 9" turn-table. List \$6.40 net \$3.76

CRYSTAL PICK-UP ARMS, Feather-weight, standard brands.

- 3 TUBE AMPLIFIERS, tone & vol. cont., uses 12SQ7, 50L6, 35Z5. Approx. size 5"x3"x1 1/2". Your net \$2.95
- 2 TUBE PHONO OSCILLATORS, good for approx. 100 uses. 12SA7, and 35Z5 tubes. Approx. size 5"x3"x1 1/2". Your net \$3.50

OUTPUT TRANSFORMERS, to match 25L6, 50L6, 2A3, 6A3, 6B4, 6Y6, 25A5C, 25B6, 25N6, 35A5, or 45 tube. Your net ea. \$5.59

CRYSTAL RADIO SETS, completely assembled, net \$1.07

HEADSETS, single earpiece, 1000 ohm. Your net \$1.19

RESISTOR KITS, consists of 100 1/2, 1 & 2 watt, 60-70 diff. values. Indiv. boxed. Your net \$1.95

SPEAKERS, 4" P.M. Alnico V. Each \$1.49. 5" P.M. Alnico V. Each \$1.59

CONDENSER KIT, paper tubular type, all fully guaranteed, .001 to .1 mfd. inclusive. Value \$15.00. Your net \$5.95

AUTO AERIALS, triple chrome admiralty brass, 60" long 3 section. Each \$1.95. Carton of 25 \$45.95

AERIAL KITS, contains everything necessary to put up good broadcast aerial. Individually boxed, with instructions. Your net \$7.75

VOLUME CONTROLS, with switch, 2" shaft. All sizes from 5,000 ohms to 2 megohms (please specify). Each \$8.50

CORD SETS, 6' A.C. rubber cord and plug set each \$1.19

6' heater cord, for irons, toaster, etc. each \$4.48

6' Brollier cords, heavy duty, High & Low each \$8.65

10' Exten. cords, cube tap end, each 30c. 10 for \$3.50

Write for the new "Free" catalog, it's just out! At least 25% off with order. We will ship balance C.O.D. Cable Address "Enardec"

National Radio Distributors

899 r Southern Blvd., New York 59, N. Y.

The BUY of a LIFETIME

U.S. SIGNAL CORPS **5 Meter** ONLY \$3.49
SHORT WAVE XMTRS. (72.2 Mc)

XMTR and Tube Only Less mks. Batteries and Antenna

One 1 1/2 volt dry cell and 67 1/2 volts of B operates it. Just attach di-pole, key or mike, connect the batteries and it's ready to use. Signal Corps spec wired with silvered wire, mica condensers, and precision resistors. Highly stable circuit with Lo-Loss silvered inductance. (Adjustable paddler.) Schematic supplied. Converts to walkie-talkie and Ham bands. Weighs less than a pound. Shipped by express only. No C.O.D.'s. No Parcel Post. A sacrifice at only \$3.49. Postal or express money order or certified check.

NEWARK SURPLUS MATERIALS CO.

324 Plane St., Dept. C, Newark 2, N.J.
SEND STAMP FOR GIANT CATALOG!

EASY TO LEARN CODE

It is easy to learn or increase speed with an Instructograph Code Teacher. Affords the quickest and most practical method yet developed. For beginners or advanced students. Available to a degree from beginner's alphabet to typical messages on all subjects. Speed range 5 to 40 WPM. Always ready—no QRM.



ENDORSED BY THOUSANDS!

The Instructograph Code Teacher literally takes the place of an operator-instructor and enables anyone to learn and master code without further assistance. Thousands of successful operators have "acquired the code" with the Instructograph System. Write today for convenient rental and purchase plans.

INSTRUCTOGRAPH COMPANY

4701 Sheridan Rd., Dept. RC, Chicago 40, Ill.

RADIO-CRAFT for MARCH, 1947

pand and push it in opposite direction. The rod continues to rock continuously.

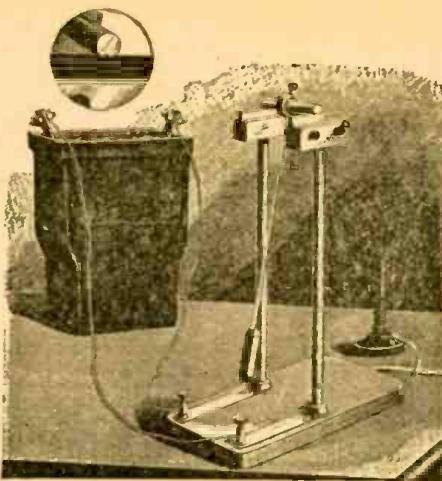

The little-known electric Trevelyan Rocker.

21. The magnetic fields of four coils, each having exactly the same number of turns, are balanced against one another. A small piece of metal placed in or near one of the coils upsets the electric balance, causing an indication, usually sound in a telephone receiver. The principle is used in mine detectors.

22. Manganese dioxide.

23. A glass tube evacuated and in some

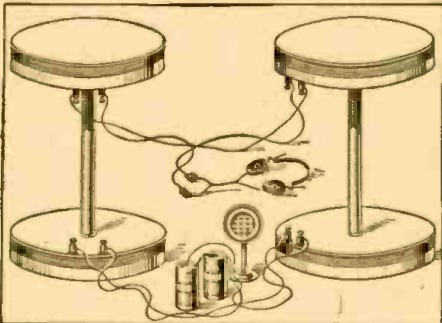

Hughes Balance, college demonstration type.

cases filled with a rare gas. Tube is lighted by applying high voltage to electrodes at its ends. Various colors are obtained by using different gases or mixing various salts into glass of tube.

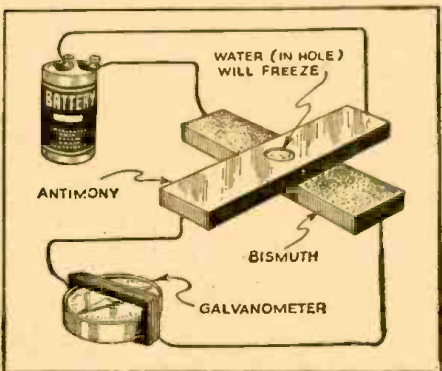

The Peltier couple is described on page 84.

24. A scientific instrument used to demonstrate radioactivity effects. It comprises a zinc-sulphide screen and a speck of radioactive mineral, such as pitchblende, placed in front of the screen. As the invisible particles emanating from the pitchblende strike the screen, flashes of light (scintillations) (Continued on page 84)

"TAB"

That's A Buy

NEW SELSYNS TYPE XXI AC SYNCHRONOUS REPEATER 115V

60cy—Made for Gunfire control Guaranteed Ordnance Insp Hi-accuracy Continuous duty Packed for overseas shipment, complete with Insp Calibration report. Per pair \$7.95



- BASIC KIT 3" CRYSCOPE-TRANSF. NAVY INSP. PRI 115V/60CY, SEC 1320V & 750VCT 110ma. 5V/2A. 2.5V/2.25A. 6.3V/2.75A & High & low Voltage Rectifier tubes, choke, Resistors, oil condns & 3BP1 tube \$16.95
- INSP GERMANIUM CRYSTAL NEW GTD... 1.39
- TRANSF 1200VCT/350ma. Pri 105-120V/50-60cy CASED 6.95
- Electronic VOM—S.C. L-107-F COMPLETE... 24.60
- TRANSF CASED S.C. Cont Duty. PRI 200 to 240 & 440V 50/60cy, SEC 3800VCT/6KV/2.7AMP (S305) 45.00
- TRANSF CASED PRI 105 to 250V/50Aidcy, SEC2240VCT 500ma. 12V/4.5A/19.2V/2.5A. 2.5V/10A, CASED GTD 11.50
- NAVY SP 3" SYNCHROSCOPE NEW COM-LETE 59.50
- CRYSTAL STD 200KC plus over minus 10 cy—Vacuum 5.95
- DYNAMIC MICROPHONE 20" CABLE WE-D17334D-A 9.95
- Pri-Transf 230Vinpri 117/112/103/93V/7amp 19.95
- CHOKER CASED 30Hy/125ma CHT NAVY 2.50

NEW REMOTE CONTROL UNIT

RM-53 (RC-261)



For voice operation of transmitter distances up to 1/2 mile from radio set—Complete with manual—Contains PL55 & PL68 cords & plugs, jacks, Mallory 4PDT switch. Two 4mfd oil condns. Transformer multi-tap UTC-600 ohmCT line to G, line to 150 or 250 ohms. K U R M A N sensitive 4MA Relay DP one normally open, other closed. Toggle switch, bushings & water proof box.

"Tab" Special \$3.49 With T17 Carbon Microphone \$5.25

- VARIABLE TRANSFORMER 200CU/880 watt with Dial & K \$14.95
- VARIABLE TRANSFORMER 200B/170 watt VARIABLE TRANSSTAT 88 to 132V/18.2Amps 110V IND 9.95
- FUSES 250ma/3AG (LP250) 48 for 29.95
- CONDENSER KIT silvermica & mica condns 50 for 1.00
- Resistor kit BT 1/2watt—50' to 2megohm ass'd 2.50
- Control kit AB2, 50 to 2megohm Pen for 2.50
- 808 Tube JAN 7.5V/4A 81. 1500V/200W P, (S,7.75) 2 for 5.00
- 2AP1 CRY tube 2" (LP21) NAVY INSP... 3.95
- 854 Boxed JAN & SOCKET Two for 1.35
- 829B/3F29 JAN BOXED Gtd 4.50
- 3B24 H.V. Rectifier 20000V/60ma (LP312) 4.95
- 2V3G JAN HV RECT. Two for 1.50
- 446A/2C40 Lighthouse tube (S13) 3.95

1 1/2%	2000	4000	(Rest 1%)
5000	5000	7500	4300*
10000	15000	17000	7950*
50000	75000	100000	30000*
140000	147000	168750	201000
220000	250000*	350000*	

"TAB" SPECIAL 3 for \$1.00 Precision Wire Wound Resistors IRC, STALLCROSS, MEXICO, INST RES. CO. — OHMITE FOR METERS BRIDGES, AMPLIFIERS. 25000 204000 314000 333500 333100 400000 402000 422000 458000 478000 THREE FOR \$1.50 500000 800000 700000 3 for \$1.95 1 MEGOHM 1% accy

SPRAGUE 10mc TenKv MEGOMAX MFA1 51.75 SPRAGUE 12mc 12KV MEGOMAX MFA1 1.95 IRC WW150F1% Hmetally Sealed Navy Re. sitors (\$24) 1.69

WRITE FOR OTHER SIZES FROM STOCK \$2 Min. order FOB N.Y.C. Add Postage all orders and 25% deposit, worth 2-7230. Send for catalog 300. Specialists in International Export. School, College & Industrial trade. Money Back Guarantee.

"TAB" DEPT. RC3

6-A CHURCH STREET, NEW YORK 6, N. Y.

All the Science of BASIC RADIO- ELECTRONICS in one 3½ lb. book



ONLY \$5

Complete

WRITTEN FOR
BEGINNERS

36 COURSES IN ONE

If this big 972-page Book were broken into monthly lessons and sold as a "course" you'd regard it as a bargain at \$30 or more!



START NOW!

thought possible! It has given more people their start in Radio than any other! It is used more for home study and was more widely used in U. S. Army Signal Corps and Navy war-time training programs than any other book of its type!

LEARN IN A FEW WEEKS!

RADIO PHYSICS COURSE is written for beginners who want to learn at home in spare time. Many who never even studied a circuit diagram before have completed it in a few weeks. Every basic subject is fully covered. Nothing is omitted. You'll be pleased how quickly it has you understanding subjects that other books and courses make seem too complicated. Send coupon today! Our 5-DAY MONEY-BACK GUARANTEE protects you absolutely.

"Better than a \$150 Course!"

"I had already taken a \$150 radio course," writes Gerard Champagne of Montreal, "but since reading RADIO PHYSICS COURSE, I put the other one away. Ghirardi's is the book I need because it teaches so clearly!"

NO RISK COUPON mail today

Dept. RC-37, Murray Hill Books, Inc.,
232 Madison Ave., New York 16, N. Y.

Enclosed find \$5 (\$3.50 foreign) for a copy of Ghirardi's 972-page RADIO PHYSICS COURSE book; or send C.O.D. for \$5 plus postage (no foreign C.O.D.'s). In either event, if not satisfied, it is understood I may return book in 5 days for complete refund of my money.

Name

Address

City & Dist. No. State

**YOU'LL NEVER GO WRONG
on a GHIRARDI BOOK!**

INDEX TO ADVERTISERS

Adson Radio Co.	62	Ohmite Mfg Co.	38
Bass & Weber Co., Inc.	79	The Fensholt Co.	65
Allied Radio Corporation.	74	Olson Radio Warehouse	65
George Brodsky Advertising		Jessop Advertising Company	77
Almo Radio Co.	74	Opportunity Adlets	61
E. L. Brown Co.	64	Pa-Kette Radio Co.	61
Altec Lansing Corp.	Inside Back Cover	Arrow Advertising Co.	64
Reiss Advertising		George W. Pearce, Jr.	69
American Television Laboratories, Inc.	13	Precision Apparatus Co.	75
Turner Advertising Agency		Shappe-Wilkes, Inc.	75
Amplifier Corporation of America	75	Precision Electronics, Inc.	5
Sternfield-Godley		Campbell & Reynolds	
Audel Publishers	83	Pyramid Electric Co.	5
Grant & Wadsworth		The Arnold Cohan Corp	
Bell Telephone Labs	8		
N. W. Ayer & Son	82		
Best Vibrator Company	67		
Brady, W. H.	74		
Brady-Parkinson Co.	62		
Brooks & Associates, George	64		
The Schram Advertising Company	76		
Buffalo Radio Supply	62		
International Advertising Agency	62		
Burstein-Applebee Co.	64		
Frank E. Whalen Advertising Company	62		
Duysen's Syndicate	62		
C. F. Cannon	14		
M. J. Werner Advertising	60		
Capitol Radio Engineering Institute	67		
Henry J. Kaufman & Associates	63		
Chief Electronics Co.	12		
Cleveland Institute of Radio Electronics	45		
Kenneth Kolpein Advertising	74		
Commercial Radio	60, 66		
Goulston Co., Inc.	73		
Communications Equipment Co.	9		
Borough Advertising Co.	63		
Concord Radio Corp.	79		
E. H. Brown Advertising Agency	72		
Constant Electric	58, 59		
Coyne Electrical School	69		
Phil Gordon Advertising Agency	72		
Coyne Electrical School	69		
McJunkin Advertising Agency	72		
Crabtree Wholesale Radio	69		
De Forest's Training Inst.	9		
Lauesen & Solomon	63		
Deer & Taylor Co.	79		
Spencer W. Curtiss Advertising	69		
Dow Radio	69		
Editors and Engineers, Ltd.	72		
Electronic Parts, Inc.	58, 59		
Campbell & Reynolds Advertising	69		
Esse Radio Co.	79		
Gary A. Ruben Advertising	76		
Federated Purchaser, Inc.	63		
Bergman-Jarrett	64		
Flanagan Radio Corp.	78		
Stewart-Jordan Co.	61		
General Cement Mfg. Co.	64		
Sander Rodkin Advertising Agency	64		
General Electronic Distributing Co.	77		
Bass & Weber Co., Inc.	68		
General Test Equipment Co.	66		
Suzanne Hayman Adv.	49		
Greenwich Sales Co.	61		
Bass & Weber Co., Inc.	61		
Hallcrafters Co.	Back Cover		
Burton Browne	70, 71		
Hallmark Electronic Corp.	51		
Harrison Radio Co.	40, 77, 82		
Altomari Advertising Agency	60		
Hershel Radio Co.	42, 43		
Hugh Allen Agency	78		
Highbridge Radio-Television & Appliance Co.	81		
Burke & Wayburne Advertising Agency	11		
Instructograph Co.	6		
Turner Advertising Agency	81		
Lafayette Radio	1		
Reiss Advertising Agency	11		
Lake Radio Sales Co.	6		
Sander Rodkin Advertising Agency	6		
Leeds Radio Co.	6		
Bass & Weber Co., Inc.	6		
Leotone Radio Corp.	6		
Altomari Advertising Agency	6		
Lifetime Sound Equipment Co.	6		
The Miller Agency Co.	6		
McMurdo-Silver Co., Inc.	6		
Edward Owen & Co.	6		
P. R. Mallory & Co., Inc.	Back Cover		
Aitkin-Kynett Co.	70, 71		
Maritime Switchboard	51		
Metropolitan Elec. & Instrument Co.	40, 77, 82		
Bass & Weber Co., Inc.	60		
Murray Hill Books, Inc.	42, 43		
Harry P. Bridge	78		
N. J. Industrial Company	81		
N. Y. Technical Institute of N. J.	1		
Schwab & Beatty, Inc.	11		
National Plans Co.	6		
National Radio Distributors	81		
Burke & Wayburne Advertising Agency	1		
National Radio Institute	11		
Van Sant, Dugdale & Co.	6		
National Schools	81		
The Mavers Co.	1		
Newark Electric Co., Inc.	6		
The Charles Brunelle Co.	6		
Newark Surplus Materials Co.	81		
Wm. N. Scheer Advertising Agency	61		
Newcomb Audio Products Co.	78		
Stevens Hall Advertising			
Niagara Radio Supply			
Burke & Wayburne Advertising Agency			

RADIO SCHOOL DIRECTORY (See page 84)

American Radio Institute	57
Sternfield-Godley Adv.	72
Baltimore Technical Inst.	53, 54
Candler System Co.	40
Rand-Ries Adv. Inc.	76
Commercial Radio Institute	56
Lincoln Engineering School	55
Buchanan-Thomas Adv.	64
Don Nathan School of Radio Arts	65
Melville Radio Institute	55
Seidel Advertising	66
RCA Institute	58
Tri-State College	75
Clem J. Steigmeyer	69
United Radio Television	66
Radcraft Publications, Inc.	54
Radio Center	40
Radio-Craft Dealers	53, 54
Radio Dealers Supply Co.	40
Burke & Wayburne Advertising Agency	76
Radio Distributing Co.	56
Radio Electric Service Co.	55
David Zibman Adv.	64
Radio-Electronics Publishing Corp.	65
George Elliott Advertising	64
Radio-Experts	65
Radio Kits Co.	55
Hamburg Advertising Agency	66
Radio Paris Company	58
Sydney Lovitt Advertising	75
Radio Publications	69
Radolek Co.	66
Turner Co.	58
Randolph Radio Stores	75
Reed Mfg. Co.	69
Borg Advertising Agency	3
Howard W. Sams and Co., Inc.	16
Aitkin-Kynett Co.	7
Sprague Products	73
H. P. Bridge Advertising	75
Spreyberry Academy of Radio	15
Harry P. Bridge Advertising	46
Michael Stahl	39
Bass & Weber Co., Inc.	2
Sterling Electronic Co.	81
Superior Instruments	60
Bass & Weber Co., Inc.	66
Supreme Instruments Corp.	4
O'Callaghan Adv.	57
Supreme Publications	47
Henry H. Teplitz Advertising	74
Sylvania Electric Products, Inc.	73
Newell-Emmett Co.	73
"TAB" Technical Apparatus Bldrs.	75
Bass & Weber Co., Inc.	15
Tiret Electric Co.	46
Transvision, Inc.	39
H. J. Gold Co.	2
Triplett Electrical Instruments Co.	81
Western Advertising Co.	60
Trutone Products Co.	66
Julius J. Rowen Co.	4
Turner Company	57
W. D. Lyon Co.	47
Variety Electric Co.	74
Bass & Weber Co., Inc.	73
Vision Research Laboratories	73
Abner Robbins Advertising	76
Wright, Inc.	76
Key Advertising Agency	64
X.L. Radio Labs	64

Guaranteed Factory Rebuilt Radio VIBRATORS - \$1.00 ea.

6 Volt Non-Synchronous Vibrators
\$1.00 ea.
6 Volt Synchronous, 12, 32, and
110 volt Vibrators \$1.25 ea.
Defective parts replaced.

48 HOUR SERVICE

For the very prompt service enclose remittance and return postage. We rebuild any make or kind of radio vibrators. C.O.D. orders accepted. Send your old vibrators to
BEST VIBRATOR CO., Box 5802-Y
CLEVELAND 1, OHIO

BOOK REVIEWS

A CHRONOLOGICAL HISTORY OF ELECTRICAL DEVELOPMENT, compiled by E. S. Lincoln. Published by National Electrical Manufacturers Association. Stiff cloth covers, 6¼ x 9¼ inches, 106 pages, plus 24-page appendix and index. Price \$2.00.

Beginning with the discovery of static electricity by Thales in 600 B.C., when he rubbed a piece of amber with a cloth, this book lists, progressively, all important discoveries and developments through 1944.

The years are listed chronologically along the left-hand edge of each page. One or more paragraphs are devoted to each notable development and happening of that year.

The appendix lists, according to the present name of the firm, member companies of the NEMA as of January 1946. Under these headings may be found the original name of the firm, date of founding, name of the founder and the first president.

COYNE RADIOMAN'S HANDBOOK. A Reference and Data Book. Compiled and prepared by the technical staff and published by the Coyne Electrical School. Flexible pebbled covers, 4½ x 7 inches, 355 pages. Price \$3.25.

A useful handbook containing, according to the title page: formulas—methods — charts — rules — diagrams — circuits — laws — specifications — tests — emergency repair data — definitions — design.

The first part contains tables and formulas covering mathematics, symbols and various physical properties of materials. Drill sizes, machine screw and sheet metal data are given, together with other data.

The resistance and insulation section contains tables of copper wire properties, resistance wire data, and color codes for resistors. The chapter on electrical circuits covers Ohm's Law, with formulas and simple chart for computing volts, ohms and amperes quickly. Formulas for series and parallel cir-

cuits are given and, under "Power," new formulas and nomographs are presented.

Capacitors and capacitance receive goodly treatment, including color code charts for condensers. A large section is devoted to receiving tubes, with tables giving constants of tubes, socket connections, cathode data, replacement tube data, etc.

Coil winding tables and simple formulas for computing the inductance and resistance of different types of windings are given complete treatment.

A.c., d.c., and battery power supplies are covered in diagram and text. Receiving circuits of various types are discussed, and the alignment of receiver circuits, including FM sets, is included.

Among other subjects of practical importance are oscillators and antennas; sound systems (including tables and formulas on decibels and their meaning), meters and measurements, and others.

A complete index makes it easy to refer instantly to any one of the several hundred radio subjects covered. Many tables and formulas in this book have not appeared before. One of the most valuable features of the book is that the practical radioman, with only a fair education, can understand the subject matter and mathematics.—H.W.S.

INDUSTRIAL ELECTRICAL HEATING AND ELECTRICAL FURNACES, by E. S. Lincoln. Published by Essential Books. Stiff cloth covers, 5½ x 8½ inches, 192 pages. Price \$3.00

Covering the fundamentals of electrical heating, this book will be of particular interest to industrial and thermodynamic engineers. The first half is devoted almost entirely to a discussion of resistance heating as applied to convection and immersion heating and electrically-operated steam generators. Separate chapters, in this section, are devoted to charts and tables of engineering material on various types of resistance wires and elements used in electrical heating.

The second half of the book covers industrial applications of electrical heating equipment with comparisons between arc, resistance, and induction heating. This section concludes with a discussion of high- and low-frequency induction heating apparatus and its selection, operation, and installation.

THE PEOPLE LOOK AT RADIO, by Paul F. Lazarsfeld and Harry Field. A report on a survey conducted by the National Opinion Research Center of the University of Denver, analyzed and interpreted by the Bureau of Applied Social Research, Columbia University. Published by the University of North Carolina Press. Stiff cloth covers, 5¼ x 8¼ inches, 158 pages. Price \$2.50.

(Continued on page 84)

7 DAYS FREE EXAMINATION

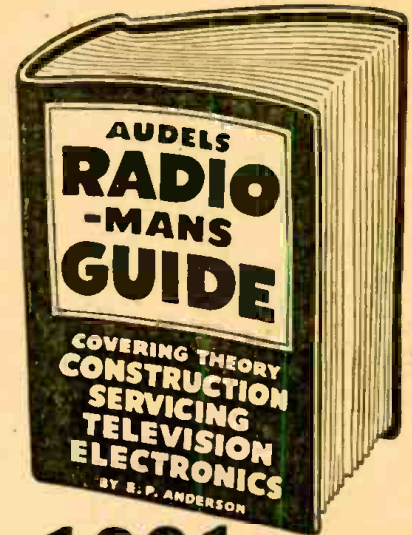

1001 RADIO FACTS AND FIGURES

AUDELS RADIOMANS GUIDE—914 Pages, 633 Illustrations, Photos, Wiring Diagrams, 38 Big Chapters, covering Radio Theory, Construction, Servicing, including Important Data on Developments in Television, Electronics and Frequency Modulation, Review, Questions and Answers, Calculations & Testing. Highly Endorsed—Indispensable for Ready Reference and Home Study.

\$4 COMPLETE • PAY ONLY \$1 A MONTH Step up your own skill with the facts and figures of your trade. Audels Mechanics Guides contain Practical Inside Trade Information in a handy form. Fully Illustrated and Easy to Understand. Highly Endorsed. Check the book you want for 7 days' Free Examination.

Send No Money. Nothing to pay postman.

CUT HERE MAIL ORDER

AUDEL, Publishers, 49 W. 23 St., NEW YORK 10, N. Y.

Please send me postpaid for FREE EXAMINATION books marked (x) below. If I decide to keep them I agree to mail \$1 in 7 days on each book ordered and further mail \$1 monthly on each book until I have paid price. Otherwise, I will return them.

- RADIOMANS GUIDE, 914 Pages . . . \$4.
- ELECTRICIANS EXAMINATIONS, 250 Pages . . . 1.
- WIRING DIAGRAMS, 210 Pages . . . 1.
- ELECTRICAL DICTIONARY, 9000 Terms . . . 2.
- ELECTRICAL POWER CALCULATIONS, 425 Pgs. . . 2.
- HANDBOOK OF ELECTRICITY, 1340 Pages . . . 4.
- ELECTRONIC DEVICES, 216 Pages . . . 2.
- ELECTRIC LIBRARY, 12 vol., 7000 Pgs., \$1.50 vol. . . 1.
- OIL BURNER GUIDE, 384 Pages . . . 1.
- REFRIGERATION & Air Conditioning, 1280 Pgs. . . 4.
- POWER PLANT ENGINEERS Guide, 1300 Pages. . . 4.
- PUMPS, Hydraulics & Air Compressors, 1658 Pgs. . . 4.
- WELDERS GUIDE, 400 Pages . . . 1.
- BLUE PRINT READING, 416 Pages . . . 2.
- SHEET METAL WORKERS Handy Book, 383 Pgs. . . 1.
- SHEET METAL PATTERN LAYOUTS, 1160 Pgs. . . 4.
- AIRCRAFT WORKER, 240 Pages . . . 1.
- MATHEMATICS & CALCULATIONS, 700 Pgs. . . 2.
- MACHINISTS Handy Book, 1600 Pages . . . 4.
- MECHANICAL Dictionary, 968 Pages . . . 4.
- AUTOMOBILE GUIDE, 1540 Pages . . . 4.
- DIESEL ENGINE MANUAL, 400 Pages . . . 2.
- MARINE ENGINEERS Handy Book, 1260 Pages . . . 4.
- SHIPFITTERS Handy Book, 272 Pages . . . 1.
- MECHANICAL DRAWING COURSE, 160 Pages . . . 1.
- MECHANICAL DRAWING & DESIGN, 480 Pgs. . . 2.
- MILLWRIGHTS & Mechanics Guide, 1200 Pgs. . . 4.
- CARPENTERS & Builders Guides (4 vols.) . . . 6.
- PLUMBERS & Steamfitters Guides (4 vols.) . . . 6.
- MASONS & Builders Guides (4 vols.) . . . 6.
- MASTER PAINTER & DECORATOR, 320 Pgs. . . 2.
- GARDENERS & GROWERS GUIDES (4 vols.) . . . 6.
- ENGINEERS and Mechanics Guides . . . 1.
- Nos. 1, 2, 3, 4, 5, 6, 7 and 8 complete . . . 12.
- Answers on Practical ENGINEERING . . . 1.
- ENGINEERS & FIREMANS EXAMINATIONS . . . 1.

Name _____
 Address _____
 Occupation _____
 Employed by _____ R.C.F.

RADIO TERM ILLUSTRATED



Suggested by:
 No name submitted
 Kernersville, N. C.

A Good Connection.

RADIO SCHOOL DIRECTORY

PREPARE NOW FOR SKILLED JOBS IN RADIO AND ELECTRONICS

CAREERS in RADIO

INTENSIVE COURSES—Thorough, technical education for progressive men and women.

1. **RADIO TECHNICIAN**—The MRI General Course. Includes F.M. & Television. Prepares For FCC Broadcast Licenses.
2. **RADIO & TELEVISION SERVICING**—Prepares for employment as Repairman on Standard Broadcast, F.M. & Television Receivers.
3. **RADIO COMMUNICATIONS**—Prepares for FCC Operators' License. Leads to position as Merchant Marine or Flight Radio Officer, Commercial Operator.
4. **FUNDAMENTAL RADIO MATHEMATICS**—The MRI Preparatory Course. Required pre-training for students lacking a basic mathematical background.

MELVILLE RADIO INSTITUTE
45 W. 45th St., N. Y. 19, BR 9-5080
"The Radio School Managed By Radio Men"

Licensed by the State of New York

MELVILLE RADIO INSTITUTE

45 West 45th St., New York 19, N. Y.
GENTLEMEN: RC

Send me FREE information about your school.

Name.....

Address.....

MAIL THIS COUPON NOW

BOOK REVIEWS

(Continued from page 83)

A highly interesting short survey of the field, this book was the result of a survey undertaken for the National Association of Broadcasters by the University of Denver's National Opinion Research Center.

Unlike other recent books on the same subject, the problems of the broadcaster as well as those of the listener are considered in some detail. The main subjects of discussion are the people's overall appraisal of broadcasting, advertising, programming problems and criticism. There is an appendix of 28 tables.

RADIO ALPHABET. A Glossary of Radio Terms. Published by Hastings House. Stiff cloth covers, 5½ by 8¼ inches, 85 pages. Price \$1.50.

This little dictionary of radio terms is edited by a string of Columbia Broadcasting System technicians and officials too long to print, and amply long enough to guarantee the authenticity of the terms and their definitions.

Only such technical terms as the layman is likely to encounter are defined. The others are the special vocabulary of the studio operators and the transmitting engineers, and vary from "agency, announcement, amplitude modulation" to "animator" (a device used in television). Slang terms are covered, but not to the exclusion of serious ones.

ELEMENTARY WAVE MECHANICS, by W. Heitler, professor of theoretical physics in the Dublin Institute for Advanced Studies. Published by the Oxford University Press. Stiff cloth covers, 5 by 8 inches, 136 pages. Price \$2.25.

This little book, useful to the serious student of nucleonics, devotes itself to the electron in its relation to the atom to which it is bound.

Elementary only in the sense that a minimum of mathematics is used, a knowledge of calculus and classical physics is expected of the reader. The two last chapters, headed Theory of the Homopolar Chemical Bond, and Valency, illustrate the usefulness of wave mechanics for chemical problems.

STUDENTS' RADIO QUIZ

(Continued from page 81)

are observed through a lens.
25. Cold may be produced by passing direct current through a couple formed by a bar of antimony and one of bismuth, as shown in the drawing (page 81). This is known as the Peltier cross.

Allow 4 points per question and grade yourself. The exact grade is unimportant. Now divide the examination in two halves. (For good measure count question 13 in each part). Allow 8 points per question. The first half will give you your grade as a specialized radio-man, and should not be below 84. The second half will show your broad general knowledge of physics and electronics. A mark of 48 is good; 64 excellent; 72 is the mark for a Doctor of Physics; and 80 is the genius point.



RCA INSTITUTES, Inc.

Offer thorough training courses in all technical phases of Radio and Television

DAYS—EVENINGS WEEKLY RATES
VETERANS: RCA Institutes is approved under G. I. Bill of Rights

For Free Catalog Write Dept. RC-47

RCA INSTITUTES, Inc.

A Service of Radio Corporation of America
75 VARICK STREET NEW YORK 13, N. Y.

RADIO ENGINEERING I

DEGREE IN 27 MONTHS

VETERANS can complete work here in shortest possible time. Courses also in Civil, Electrical, Mechanical, Chemical, Aeronautical Engineering; Business Administration, Accounting, Secretarial Science, 63rd year. Enter Mar., June, Sept., Jan. School now filled to capacity. No applications can be accepted until further notice.

TRI-STATE COLLEGE 2437 College Ave. ANGOLA INDIANA



CORRESPONDENCE COURSES IN RADIO and ELECTRICAL ENGINEERING

ELECTRICAL ENGINEERING Get good grasp of wide electrical field. Prepare yourself at Low Cost, for secure future. Modern course. So simplified anyone can understand quickly.
RADIO ENGINEERING Extra fine course in radio, public address, photo-electric work. Trains you to be super-service man, real vacuum-tube technician. Servicemen needed badly. Diploma on completion. Many graduates earning big pay.

Send postcard for Free Copies of school catalog, full details, all \$25 Either WRITE about deferred payment plan, experimental kits, etc. Course Lincoln Engineering School, Box 931C—97, Lincoln 2, Neb.

SENDING SPEED CODE RECEIVING

Be a "key" man. Learn how to send and receive messages in code by telegraph and radio. Commerce needs thousands of men for jobs. Good pay, adventure, interesting work. Learn at home quickly through famous Candler System. Write for FREE BOOK.
CANDLER SYSTEM CO.
Dept. 3-C, Box 928, Denver 1, Colo., U.S.A.

AN ENGLISH RADIO POEM

"In the little town of Electron, away out beyond Anode Bend, is the grave of a radio mechanic, who lies earthed at his positive end. Let us give him his due in all fairness—he was good at his job; he had brains. But he once was a little too careless while fixing a plug to the mains."

There's a moral to this little story, a moral an infant could see. If you don't want short circuits to Glory, don't fool around with H. T.!

COMMERCIAL RADIO INSTITUTE

A radio training center for twenty-six years.

RESIDENT COURSES ONLY

Broadcast, Service, Aeronautical, Television and Marine telegraphy classes; Preparation Course now forming. Literature upon request. Veteran training. Classes now forming for July 1st.

Dept. C, 38 West Biddle St., Baltimore 1, Md.

SOUND RECORDING SCHOOL

A practical 9 months' course in Sound Fundamentals, Recording, and Sound Transmission measurements; in a laboratory containing transmission sets, oscillators, square wave generator and intermodulation analyzer, and other equipment.

Two complete recording studios assimilating broadcast, motion picture and commercial sound recording, under the direction of H. M. Tremaine.

Approved for Veterans
DON MARTIN SCHOOL OF RADIO ARTS
1635 Cherokee St., Hollywood, Calif.

RADIO COURSES

Servicing, Broadcast Engineering, Commercial Operating, Television

INDIVIDUAL LABORATORY WORK—LEARN BY DOING! DAY AND EVENING CLASSES

Approved by the Maryland State Department of Education and the Veterans Administration

FREE TO VETS—TEXTBOOKS, TOOLS, TEST SET

Write for Bulletin
BALTIMORE TECHNICAL INSTITUTE
1425 Eutaw Place—Dept. C, Baltimore 17, Maryland

RADIO

RADIO Technician and Radio Communications courses. Register now for new classes starting first MONDAY of each month. Day and Evening Classes.

AMERICAN RADIO INSTITUTE

101 West 63rd St., New York 23, N. Y.
APPROVED UNDER GI BILL OF RIGHTS.

LEARN

RADIO—TELEVISION—FM

Complete courses in all phases given in both day and evening classes.

Veterans accepted under G.I. bill
United Radio Television Institute
225 Halsey Street Newark 2, N. J.

De Forest Anniversary Issue

We can still supply a limited number of the BIG January Anniversary issue.
50c each postpaid.

RADIO-CRAFT

25 West Broadway New York 7, N. Y.



Try This!

Call those of your customers who own fine radios—*people to whom you have sold radios or homes in which you have serviced radios.* Tell them you have a speaker that will make their old sets sound as fine as any brilliant 1947 model. Arrange to demonstrate this Altec Lansing speaker* in their homes. Suggest that they invite neighbors and friends to witness the amazing demonstration. The Altec Lansing Dia-Cone will so greatly improve tone quality and performance that further sales talk will be unnecessary.

Model 600 Dia-Cone



12-inch speaker

*Designed for installation in those fine sets where ultra-high fidelity sound reproduction is desired. This speaker employs the exclusive Dia-Cone principle, reproducing high and low frequencies from separate diaphragms.

ASK YOUR JOBBER ABOUT AVAILABILITY OF THIS SPEAKER.



"KEEP ADVANCING WITH ALTEC LANSING"

*When the Encyclopedia recommends
a WIRE-WOUND control, remember...*



Mallory is the Line That Gives You **ALL** Needed Values

A PROPER servicing job on old type radios often calls for a tapered wire-wound control. The Mallory Radio Service Encyclopedia will tell you just what's needed. And you'll find what you need in the Mallory Catalog—and at your Mallory Distributor's.

Fact is, Mallory is the manufacturer who has always made a complete line of wire-wound controls. There are thirty-three types covering every resistance value and taper . . . many with the exclusive Mallory adjustable bias feature . . . all equipped with the universal channel shaft and insert that fits all types of knobs.

Make it a Mallory wire-wound control, and you can't go wrong.

You Expect More—and Get More—from Mallory

**Insist on MALLORY—the
Complete Control Line**

*Mallory is the manufacturer
that offers:*

- 33 Correctly Tapered Wire-Wound Controls
- 31 Values in Single Tapped Controls
- 10 Values in Double Tapped Controls
- 12 Clutch Type Controls
- 10 Universal Dual Controls
- 92 Popular Special Controls

P. R. MALLORY & CO. Inc.
MALLORY

VIBRATORS . . . VIBRAPACKS® . . . CAPACITORS . . . VOLUME
CONTROLS . . . SWITCHES . . . RESISTORS . . . FILTERS
. . . RECTIFIERS . . . POWER SUPPLIES.

®Reg. U. S. Pat. Off.

APPROVED PRECISION PRODUCTS

P. R. MALLORY & CO., Inc., INDIANAPOLIS 6, INDIANA

ADV Plans, LLC

Copyright Notice:

The entire contents of this CD/DVD are copyright 2014 by ADV Plans, LLC. All Rights Reserved.

Reproduction or distribution of this disk, either free or for a fee is strictly prohibited. We actively monitor and remove listings on eBay thru Vero.

You are free to copy or use individual images in your own projects, magazines, brochures or other school projects.

Only the sellers listed here are authorized distributors of this collection:
www.theclassicarchives.com/authorizedsuppliers

Please view our other products at
www.theclassicarchives.com,
or our ebay stores:

[TheClassicArchives](#)
[ADVPlans](#)
[SuperShedPlans](#)

